

Ergebnis: **392** (408.5)
 Serien: 97 100 100 95 10
 Zähler: 34 6 1 0 0 0 0 0 0
 Innenzehner: 28
 weiteste: 519 (39), 437 (33), 414 (38)
 beste Teiler 30.6 (29.) 36.0 (23.) 69.2 (31.)
 Trefferlage 0.51 mm links, 0.10 mm hoch
 Streuwert 1.47, horizontal: 1.37, vertikal: 1.56

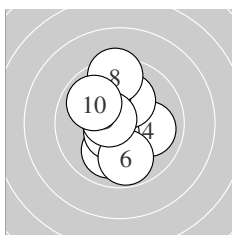

Serie 1:
 10.3 * 10.2 * 10.0 ✓ 10.0 → 10.6 *
 9.8 ↓ 10.2 * 9.4 ↑ 10.6 * 9.9 ↘
 beste Teiler 90.8 (9.) 99.8 (5.) 166.0 (1.)
 Trefferlage 0.03 mm rechts, 0.08 mm tief
 Streuwert 1.71, horizontal: 1.31, vertikal: 2.04

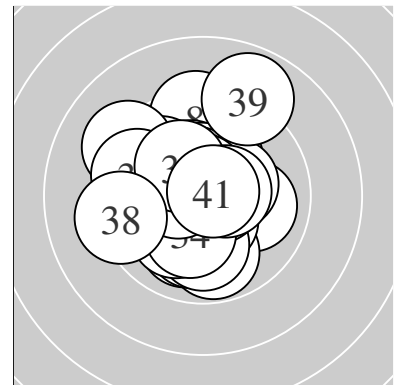
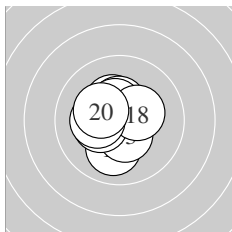

Serie 2:
 10.0 ↓ 10.6 * 10.5 * 10.3 * 10.3 *
 10.4 * 10.5 * 10.3 * 10.2 * 10.3 *
 beste Teiler 89.2 (12.) 118.9 (17.) 125.3 (13.)
 Trefferlage 0.52 mm links, 0.19 mm hoch
 Streuwert 1.09, horizontal: 0.98, vertikal: 1.18

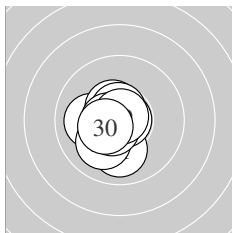

Serie 3:
 10.0 ↓ 10.0 ← 10.8 * 10.1 ✓ 10.6 *
 10.5 * 10.6 * 10.6 * 10.8 * 10.4 *
 beste Teiler 30.6 (29.) 36.0 (23.) 80.8 (27.)
 Trefferlage 0.65 mm links, 0.32 mm tief
 Streuwert 0.94, horizontal: 0.80, vertikal: 1.06

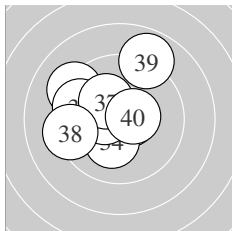

Serie 4:
 10.7 * 10.6 * 9.2 ↘ 10.2 * 10.5 *
 9.6 ↖ 10.2 * 9.3 ← 8.9 ↑ 10.5 *
 beste Teiler 69.2 (31.) 83.4 (32.) 111.1 (40.)
 Trefferlage 1.03 mm links, 0.63 mm hoch
 Streuwert 1.98, horizontal: 2.08, vertikal: 1.88

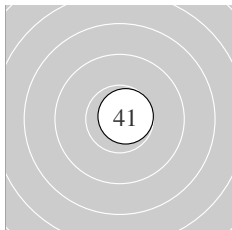

Serie 5:
 10.7 *
 beste Teiler
 Trefferlage 0.49 mm rechts, 0.22 mm hoch
 Streuwert 0.00, horizontal: 0.00, vertikal: 0.00

Unterschrift des Schützen

Meyton Elektronik

Ergebnis: **394** (414.2)

Serien: 98 99 97 100 9

Zähler: 34 7 0 0 0 0 0 0 0 0

Innenzehner: 32

weiteste: 449 (1), 353 (30), 340 (29)

beste Teiler 37.0 (15.) 37.0 (28.) 46.5 (8.)

Trefferlage 0.30 mm rechts, 0.27 mm hoch

Streuwert 1.27, horizontal: 1.41, vertikal: 1.11

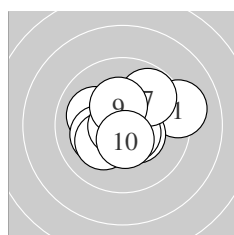
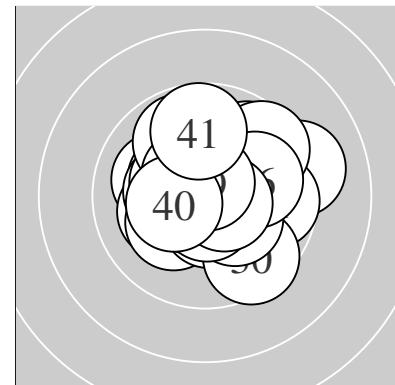

Serie 1:

9.2 →	10.1 ←	10.4 *	10.2 *	10.2 *
10.6 *	9.8 ↗	10.8 *	10.3 *	10.5 *

beste Teiler 46.5 (8.) 93.8 (6.) 112.7 (10.)

Trefferlage 0.20 mm rechts, 0.12 mm hoch

Streuwert 1.62, horizontal: 1.95, vertikal: 1.20

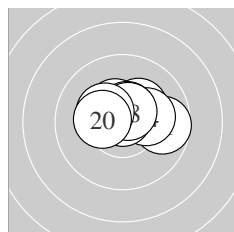

Serie 2:

9.7 →	10.5 *	10.3 *	10.2 *	10.8 *
10.4 *	10.6 *	10.6 *	10.3 *	10.3 *

beste Teiler 37.0 (15.) 93.0 (18.) 96.7 (17.)

Trefferlage 0.27 mm rechts, 0.64 mm hoch

Streuwert 1.08, horizontal: 1.46, vertikal: 0.44

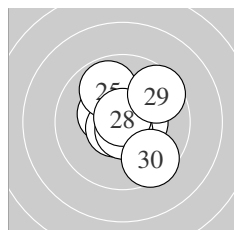

Serie 3:

10.7 *	10.6 *	10.4 *	10.6 *	9.9 ↖
10.4 *	10.7 *	10.8 *	9.6 ↗	9.5 ↘

beste Teiler 37.0 (28.) 62.6 (21.) 64.6 (27.)

Trefferlage 0.45 mm rechts, 0.10 mm hoch

Streuwert 1.41, horizontal: 1.31, vertikal: 1.50

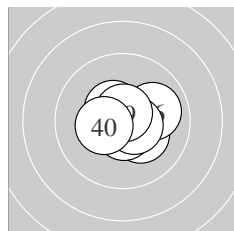

Serie 4:

10.7 *	10.7 *	10.3 *	10.7 *	10.6 *
10.0 →	10.6 *	10.5 *	10.7 *	10.4 *

beste Teiler 52.8 (32.) 63.3 (39.) 70.8 (34.)

Trefferlage 0.35 mm rechts, 0.06 mm tief

Streuwert 0.90, horizontal: 1.07, vertikal: 0.68

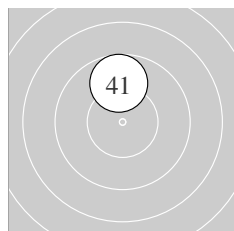

Serie 5:

9.7 ↑				
-------	--	--	--	--

beste Teiler

Trefferlage 0.30 mm links, 3.01 mm hoch

Streuwert 0.00, horizontal: 0.00, vertikal: 0.00

Unterschrift des Schützen

Meyton Elektronik

Ergebnis: **391** (411.0)
 Serien: 98 98 96 99 9
 Zähler: 31 10 0 0 0 0 0 0 0
 Innenzehner: 25
 weiteste: 467 (12), 312 (10), 307 (21)
 beste Teiler 34.1 (24.) 38.2 (34.) 40.3 (15.)
 Trefferlage 0.10 mm rechts, 0.26 mm hoch
 Streuwert 1.41, horizontal: 1.67, vertikal: 1.08

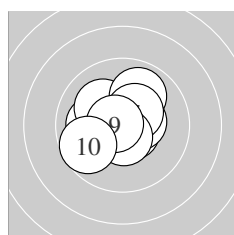
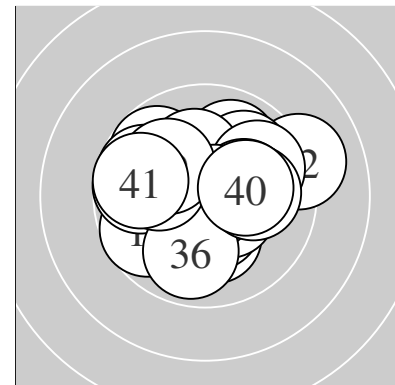

Serie 1:
 10.1 ← 10.4 * 10.1 ↘ 9.9 ↗ 10.6 *
 10.5 * 10.4 * 10.6 * 10.7 * 9.7 ↙
 beste Teiler 61.9 (9.) 83.0 (5.) 93.5 (8.)
 Trefferlage 0.41 mm links, 0.29 mm hoch
 Streuwert 1.30, horizontal: 1.45, vertikal: 1.13

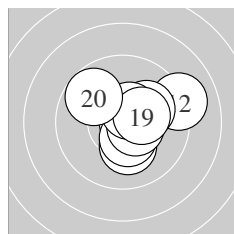

Serie 2:
 10.2 * 9.1 → 10.6 * 10.1 ↗ 10.8 *
 10.4 * 10.5 * 10.5 * 10.3 * 9.8 ↘
 beste Teiler 40.3 (15.) 99.5 (13.) 104.1 (18.)
 Trefferlage 0.88 mm rechts, 0.33 mm hoch
 Streuwert 1.45, horizontal: 1.65, vertikal: 1.22

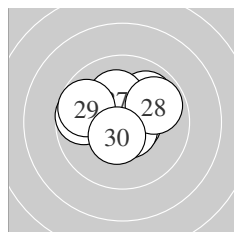

Serie 3:
 9.7 ← 10.6 * 10.6 * 10.8 * 10.7 *
 9.9 ↗ 10.2 * 9.8 ↗ 9.7 ↖ 10.5 *
 beste Teiler 34.1 (24.) 75.8 (25.) 80.0 (22.)
 Trefferlage 0.06 mm links, 0.48 mm hoch
 Streuwert 1.44, horizontal: 1.78, vertikal: 1.00

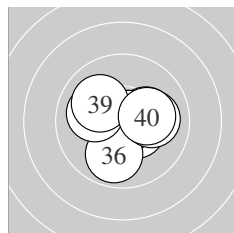

Serie 4:
 10.2 * 10.7 * 10.4 * 10.8 * 10.8 *
 9.9 ↓ 10.1 ← 10.0 → 10.1 ↘ 10.2 *
 beste Teiler 38.2 (34.) 48.7 (35.) 61.0 (32.)
 Trefferlage 0.30 mm rechts, 0.10 mm tief
 Streuwert 1.31, horizontal: 1.52, vertikal: 1.07

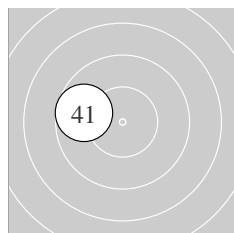

Serie 5:
 9.7 ←
 beste Teiler
 Trefferlage 3.03 mm links, 0.72 mm hoch
 Streuwert 0.00, horizontal: 0.00, vertikal: 0.00

Unterschrift des Schützen

Meyton Elektronik

Ergebnis: **389** (409.1)
 Serien: 99 97 98 95 10
 Zähler: 31 9 1 0 0 0 0 0 0
 Innenzehner: 26
 weiteste: 681 (38), 369 (39), 347 (10)
 beste Teiler 19.0 (32.) 34.5 (21.) 48.7 (5.)
 Trefferlage 0.23 mm rechts, 0.66 mm hoch
 Streuwert 1.45, horizontal: 1.42, vertikal: 1.48

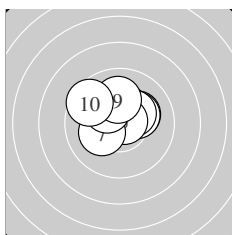
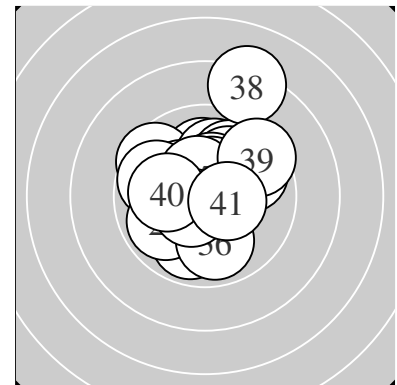

Serie 1:
 10.2 * 10.2 * 10.3 * 10.3 * 10.8 *
 10.1 ↘ 10.2 * 10.2 * 10.1 ↑ 9.6 ↙
 beste Teiler 48.7 (5.) 153.0 (3.) 158.0 (4.)
 Trefferlage 0.22 mm links, 0.99 mm hoch
 Streuwert 1.29, horizontal: 1.60, vertikal: 0.88

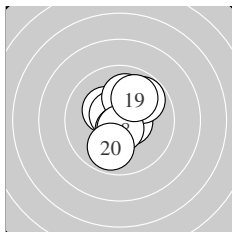

Serie 2:
 10.7 * 10.6 * 10.3 * 10.6 * 10.6 *
 10.0 ↑ 9.8 ↗ 10.6 * 9.9 ↗ 9.9 ↓
 beste Teiler 64.8 (11.) 80.3 (18.) 86.0 (14.)
 Trefferlage 0.26 mm rechts, 0.36 mm hoch
 Streuwert 1.32, horizontal: 1.07, vertikal: 1.53

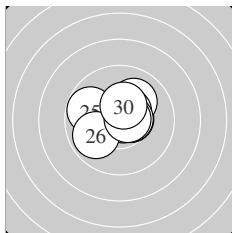

Serie 3:
 10.8 * 10.5 * 10.5 * 10.1 ↗ 9.8 ↘
 9.9 ↙ 10.5 * 10.6 * 10.6 * 10.4 *
 beste Teiler 34.5 (21.) 76.6 (29.) 97.6 (28.)
 Trefferlage 0.15 mm rechts, 0.45 mm hoch
 Streuwert 1.20, horizontal: 1.45, vertikal: 0.89

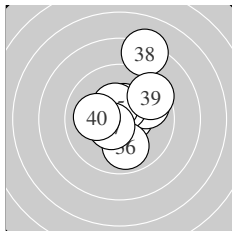

Serie 4:
 10.6 * 10.9 * 9.8 ↗ 10.5 * 10.4 *
 9.9 ↓ 10.5 * 8.2 ↑ 9.5 ↗ 10.1 ←
 beste Teiler 19.0 (32.) 98.9 (31.) 104.2 (37.)
 Trefferlage 0.62 mm rechts, 0.93 mm hoch
 Streuwert 2.01, horizontal: 1.64, vertikal: 2.32

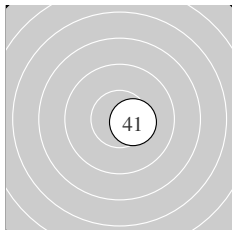

Serie 5:
 10.4 *
 beste Teiler
 Trefferlage 1.28 mm rechts, 0.30 mm tief
 Streuwert 0.00, horizontal: 0.00, vertikal: 0.00

Unterschrift des Schützen

Meyton Elektronik

Ergebnis:	388	(403.2)
Serien:	98 98 95 97 10	
Zähler:	30 10 1 0 0 0 0 0 0	
Innenzehner:	20	
weiteste:	512 (23), 417 (38), 388 (20)	
beste Teiler	52.9 (7.) 71.7 (16.) 76.2 (10.)	
Trefferlage	0.41 mm rechts, 0.41 mm tief	
Streuwert	1.65, horizontal: 1.85, vertikal: 1.43	

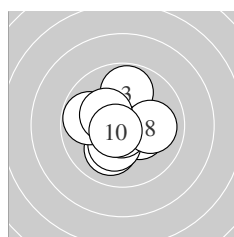
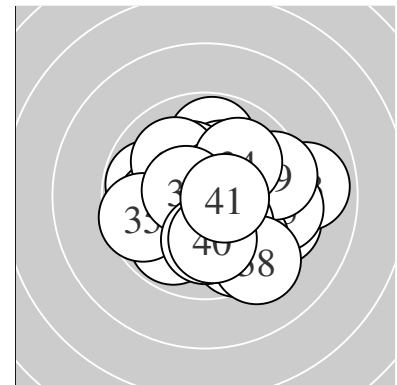

Serie 1:

10.3 *	10.1 ↘	9.8 ↑	10.3 *	10.2 *
9.8 ←	10.7 *	10.0 →	10.3 *	10.6 *

beste Teiler 52.9 (7.) 76.2 (10.) 155.6 (4.)
 Trefferlage 0.40 mm links, 0.05 mm tief
 Streuwert 1.43, horizontal: 1.49, vertikal: 1.37

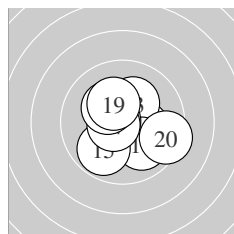

Serie 2:

10.6 *	10.3 *	10.2 *	10.0 ↘	9.8 ↘
10.7 *	10.6 *	10.3 *	10.3 *	9.4 →

beste Teiler 71.7 (16.) 80.3 (17.) 87.1 (11.)
 Trefferlage 0.31 mm rechts, 0.08 mm tief
 Streuwert 1.53, horizontal: 1.66, vertikal: 1.39

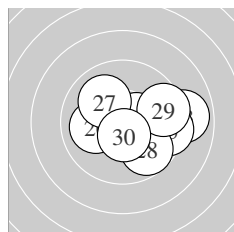

Serie 3:

10.4 *	10.5 *	8.9 →	10.0 ↘	9.4 →
10.0 ←	10.0 ↘	9.7 ↘	9.5 →	10.5 *

beste Teiler 111.6 (30.) 119.6 (22.) 142.2 (21.)
 Trefferlage 1.21 mm rechts, 0.25 mm tief
 Streuwert 1.95, horizontal: 2.48, vertikal: 1.21

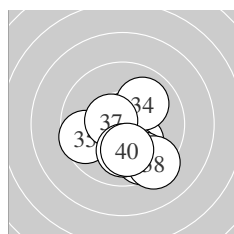

Serie 4:

10.6 *	10.2 *	10.0 ↘	10.0 ↗	9.6 ←
9.6 ↘	10.5 *	9.3 ↘	10.1 ↓	10.1 ↓

beste Teiler 79.1 (31.) 101.2 (37.) 191.5 (32.)
 Trefferlage 0.48 mm rechts, 1.29 mm tief
 Streuwert 1.63, horizontal: 1.62, vertikal: 1.64

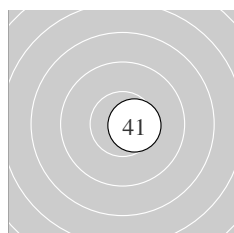

Serie 5:

10.6 *				
--------	--	--	--	--

beste Teiler
 Trefferlage 1.00 mm rechts, 0.12 mm tief
 Streuwert 0.00, horizontal: 0.00, vertikal: 0.00

Unterschrift des Schützen

Meyton Elektronik

Ergebnis:	389	(408.8)
Serien:	98	97 96 98 10
Zähler:	31	9 1 0 0 0 0 0 0 0
Innenzehner:	28	
weiteste:	562	(26), 418 (11), 310 (19)
beste Teiler	34.7	(7.) 54.0 (20.) 55.4 (37.)
Trefferlage	0.37 mm	links, 0.14 mm hoch
Streuwert	1.45,	horizontal: 1.59, vertikal: 1.30

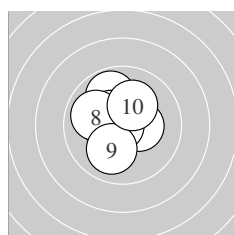
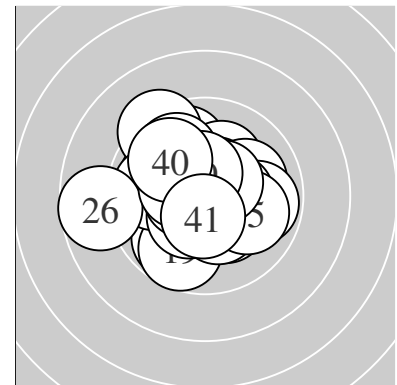

Serie 1:	10.5 *	9.8 ↖	10.2 *	10.4 *	10.4 *
	10.4 *	10.8 *	9.9 ↗	10.0 ↘	10.2 *
beste Teiler	34.7 (7.)	108.6 (1.)	133.8 (5.)		
Trefferlage	0.56 mm	links, 0.59 mm	hoch		
Streuwert	1.22,	horizontal: 1.21,	vertikal: 1.24		

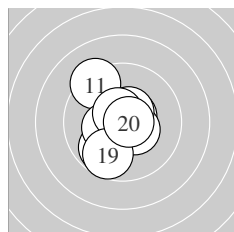

Serie 2:	9.3 ↖	9.8 ↗	10.5 *	10.6 *	10.4 *
	10.4 *	10.5 *	10.6 *	9.7 ↘	10.7 *
beste Teiler	54.0 (20.)	91.7 (18.)	95.9 (14.)		
Trefferlage	0.45 mm	links, 0.15 mm	tief		
Streuwert	1.51,	horizontal: 1.20,	vertikal: 1.76		

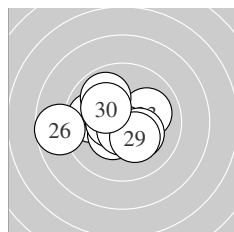

Serie 3:	9.9 ↖	10.4 *	10.0 ↗	10.5 *	10.7 *
	8.7 ↖	9.9 ↖	10.2 *	10.3 *	10.2 *
beste Teiler	71.2 (25.)	105.0 (24.)	139.4 (22.)		
Trefferlage	0.85 mm	links, 0.01 mm	tief		
Streuwert	1.79,	horizontal: 2.24,	vertikal: 1.16		

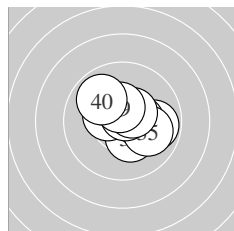

Serie 4:	10.4 *	9.8 →	10.3 *	10.4 *	10.0 →
	10.4 *	10.7 *	10.5 *	10.5 *	9.9 ↖
beste Teiler	55.4 (37.)	112.6 (38.)	124.5 (39.)		
Trefferlage	0.35 mm	rechts, 0.30 mm	hoch		
Streuwert	1.30,	horizontal: 1.55,	vertikal: 0.98		

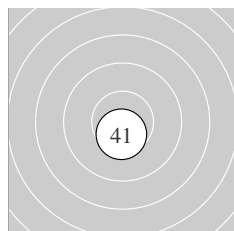

Serie 5:	10.5 *				
beste Teiler					
Trefferlage	0.11 mm	links, 1.09 mm	tief		
Streuwert	0.00,	horizontal: 0.00,	vertikal: 0.00		

Unterschrift des Schützen

Meyton Elektronik

Ergebnis: **396** (412.3)
 Serien: 100 97 100 99 10
 Zähler: 37 4 0 0 0 0 0 0 0 0
 Innenzehner: 31
 weiteste: 418 (34), 388 (18), 370 (17)
 beste Teiler 16.4 (40.) 18.4 (3.) 51.7 (22.)
 Trefferlage 0.16 mm links, 0.14 mm hoch
 Streuwert 1.31, horizontal: 1.30, vertikal: 1.32

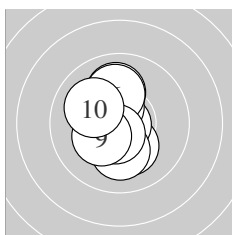
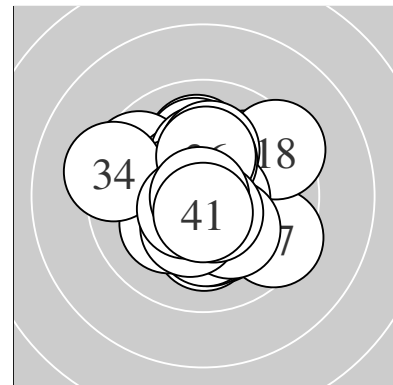

Serie 1:
 10.5 * 10.2 * 10.9 * 10.0 ↑ 10.4 *
 10.1 ↑ 10.1 ↓ 10.6 * 10.3 * 10.1 ↖
 beste Teiler 18.4 (3.) 88.0 (8.) 112.8 (1.)
 Trefferlage 0.39 mm links, 0.01 mm hoch
 Streuwert 1.24, horizontal: 0.75, vertikal: 1.59

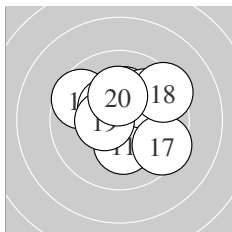

Serie 2:
 10.2 * 10.5 * 10.2 * 9.6 ↘ 10.0 ↗
 10.4 * 9.5 ↘ 9.4 ↗ 10.5 * 10.2 *
 beste Teiler 114.1 (19.) 119.6 (12.) 130.8 (16.)
 Trefferlage 0.27 mm rechts, 0.65 mm hoch
 Streuwert 1.75, horizontal: 1.99, vertikal: 1.48

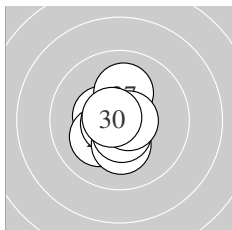

Serie 3:
 10.4 * 10.7 * 10.6 * 10.2 * 10.7 *
 10.2 * 10.1 ↑ 10.6 * 10.7 * 10.7 *
 beste Teiler 51.7 (22.) 61.6 (30.) 67.1 (29.)
 Trefferlage 0.23 mm links, 0.05 mm tief
 Streuwert 0.95, horizontal: 0.75, vertikal: 1.11

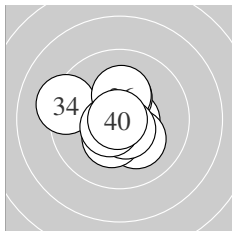

Serie 4:
 10.6 * 10.7 * 10.2 * 9.3 ↖ 10.3 *
 10.2 * 10.3 * 10.6 * 10.6 * 10.9 *
 beste Teiler 16.4 (40.) 72.0 (32.) 79.6 (31.)
 Trefferlage 0.33 mm links, 0.03 mm hoch
 Streuwert 1.32, horizontal: 1.45, vertikal: 1.16

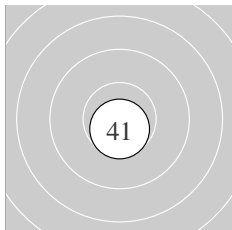

Serie 5:
 10.7 *
 beste Teiler
 Trefferlage 0.00 mm , 0.75 mm tief
 Streuwert 0.00, horizontal: 0.00, vertikal: 0.00

Unterschrift des Schützen

Meyton Elektronik

Ergebnis: **393** (411.0)
 Serien: 99 97 97 100 10
 Zähler: 34 7 0 0 0 0 0 0 0 0
 Innenzehner: 30
 weiteste: 340 (26), 301 (13), 295 (23)
 beste Teiler 71.0 (32.) 72.1 (20.) 75.1 (21.)
 Trefferlage 0.36 mm rechts, 0.17 mm hoch
 Streuwert 1.28, horizontal: 1.33, vertikal: 1.22

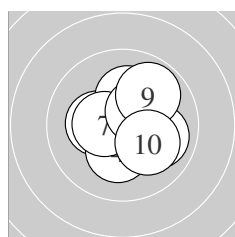
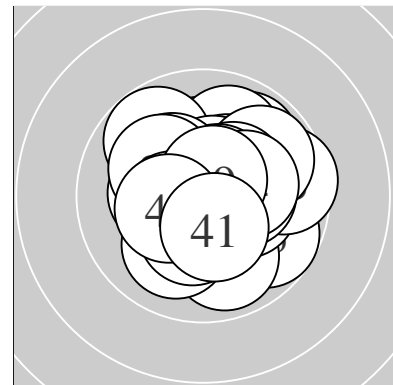

Serie 1:
 10.6 * 10.0 ↘ 10.3 * 10.3 * 10.4 *
 10.2 * 10.5 * 10.4 * 9.9 ↗ 10.1 ↘
 beste Teiler 83.2 (1.) 125.2 (7.) 140.2 (5.)
 Trefferlage 0.58 mm rechts, 0.22 mm hoch
 Streuwert 1.29, horizontal: 1.33, vertikal: 1.25

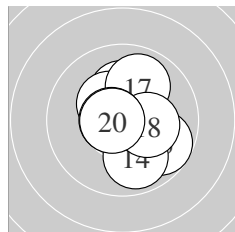

Serie 2:
 10.4 * 10.2 * 9.7 ↘ 9.9 ↓ 10.2 *
 10.4 * 9.9 ↗ 10.3 * 10.6 * 10.7 *
 beste Teiler 72.1 (20.) 77.0 (19.) 136.6 (11.)
 Trefferlage 0.56 mm rechts, 0.17 mm tief
 Streuwert 1.38, horizontal: 1.16, vertikal: 1.57

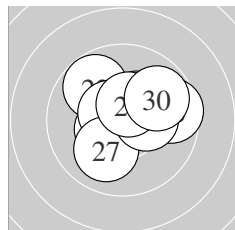

Serie 3:
 10.7 * 10.5 * 9.8 ↘ 10.6 * 10.3 *
 9.6 → 10.0 ↙ 10.3 * 10.5 * 9.8 ↗
 beste Teiler 75.1 (21.) 99.1 (24.) 115.5 (29.)
 Trefferlage 0.43 mm rechts, 0.51 mm hoch
 Streuwert 1.46, horizontal: 1.69, vertikal: 1.19

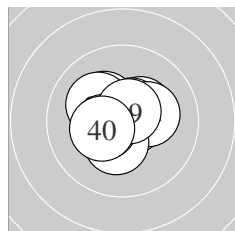

Serie 4:
 10.4 * 10.7 * 10.6 * 10.2 * 10.3 *
 10.1 ↘ 10.3 * 10.4 * 10.6 * 10.3 *
 beste Teiler 71.0 (32.) 78.5 (39.) 94.4 (33.)
 Trefferlage 0.13 mm links, 0.26 mm hoch
 Streuwert 1.05, horizontal: 1.22, vertikal: 0.84

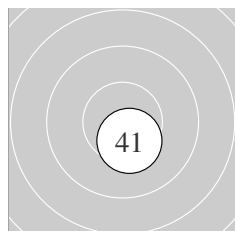

Serie 5:
 10.4 *
 beste Teiler
 Trefferlage 0.47 mm rechts, 1.30 mm tief
 Streuwert 0.00, horizontal: 0.00, vertikal: 0.00

Unterschrift des Schützen

Meyton Elektronik

Ergebnis:	392	(412.9)
Serien:	98 98 100 96	
Zähler:	32 8 0 0 0 0 0 0 0 0	
Innenzehner:	29	
weiteste:	402 (36), 378 (39), 332 (7)	
beste Teiler	14.1 (24.) 34.9 (12.) 39.5 (38.)	
Trefferlage	0.02 mm rechts, 0.36 mm tief	
Streuwert	1.31, horizontal: 1.50, vertikal: 1.07	

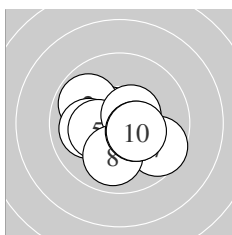
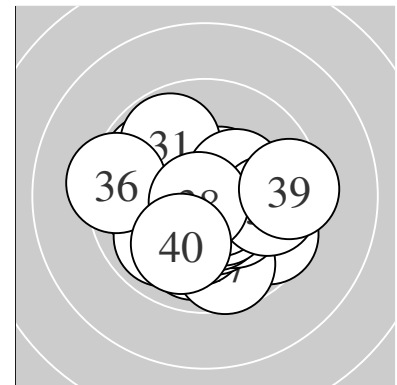

Serie 1:	10.5 *	9.9 ↖	10.0 ←	10.8 *	10.3 *
	10.5 *	9.6 ↘	10.0 ↓	10.4 *	10.4 *
beste Teiler	50.2 (4.) 101.2 (1.) 104.6 (6.)				
Trefferlage	0.11 mm links, 0.40 mm tief				
Streuwert	1.44, horizontal: 1.70, vertikal: 1.11				

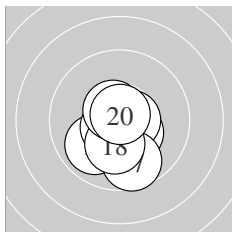

Serie 2:	9.9 ↙	10.8 *	10.8 *	10.4 *	10.6 *
	10.6 *	9.7 ↓	10.2 *	10.6 *	10.8 *
beste Teiler	34.9 (12.) 41.0 (13.) 43.1 (20.)				
Trefferlage	0.06 mm links, 0.70 mm tief				
Streuwert	1.05, horizontal: 0.87, vertikal: 1.20				

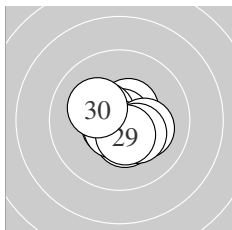

Serie 3:	10.5 *	10.7 *	10.4 *	10.9 *	10.5 *
	10.7 *	10.2 *	10.3 *	10.5 *	10.2 *
beste Teiler	14.1 (24.) 72.6 (22.) 75.2 (26.)				
Trefferlage	0.09 mm rechts, 0.25 mm tief				
Streuwert	0.95, horizontal: 1.07, vertikal: 0.82				

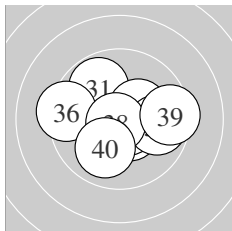

Serie 4:	9.8 ↖	10.5 *	10.6 *	10.7 *	10.3 *
	9.3 ←	9.8 →	10.8 *	9.4 →	10.0 ↙
beste Teiler	39.5 (38.) 74.6 (34.) 84.5 (33.)				
Trefferlage	0.20 mm rechts, 0.09 mm tief				
Streuwert	1.78, horizontal: 2.21, vertikal: 1.20				

Unterschrift des Schützen

Ergebnis:	392	(410.6)
Serien:	96 100 99 97	
Zähler:	32 8 0 0 0 0 0 0 0 0	
Innenzehner:	27	
weiteste:	380 (2), 349 (30), 309 (5)	
beste Teiler	49.5 (39.) 50.9 (32.) 52.2 (31.)	
Trefferlage	0.09 mm rechts, 0.32 mm hoch	
Streuwert	1.35, horizontal: 1.53, vertikal: 1.14	

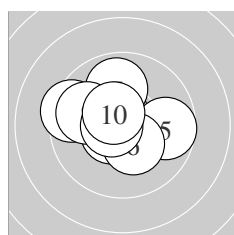
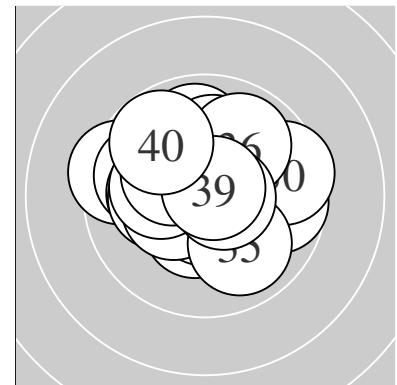

Serie 1:	10.7 *	9.4 ←	10.3 *	10.6 *	9.7 →
	10.3 *	9.9 ↑	9.9 ←	10.6 *	10.5 *
beste Teiler	70.6 (1.) 79.1 (9.) 96.2 (4.)				
Trefferlage	0.62 mm links, 0.51 mm hoch				
Streuwert	1.49, horizontal: 1.80, vertikal: 1.10				

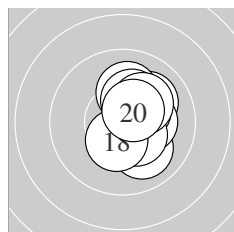

Serie 2:	10.0 ↗	10.0 ↘	10.3 *	10.3 *	10.4 *
	10.1 ↑	10.3 *	10.4 *	10.2 *	10.5 *
beste Teiler	113.2 (20.) 134.4 (15.) 136.9 (18.)				
Trefferlage	0.98 mm rechts, 0.40 mm hoch				
Streuwert	1.07, horizontal: 0.68, vertikal: 1.35				

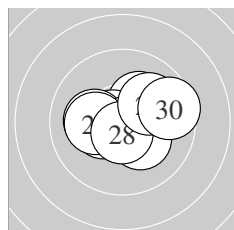

Serie 3:	10.2 *	10.7 *	10.4 *	10.1 ←	10.7 *
	10.2 *	10.3 *	10.6 *	10.0 ↗	9.6 →
beste Teiler	60.4 (25.) 69.3 (22.) 76.1 (28.)				
Trefferlage	0.21 mm rechts, 0.11 mm hoch				
Streuwert	1.39, horizontal: 1.76, vertikal: 0.87				

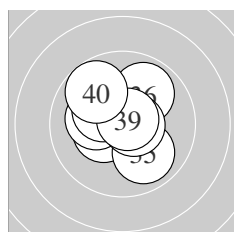

Serie 4:	10.7 *	10.8 *	10.4 *	10.2 *	9.9 ↘
	9.9 ↗	10.3 *	10.6 *	10.8 *	9.8 ↖
beste Teiler	49.5 (39.) 50.9 (32.) 52.2 (31.)				
Trefferlage	0.20 mm links, 0.26 mm hoch				
Streuwert	1.32, horizontal: 1.33, vertikal: 1.31				

Unterschrift des Schützen

Meyton Elektronik

Ergebnis: **385** (402.5)
 Serien: 97 95 96 97
 Zähler: 25 15 0 0 0 0 0 0 0 0
 Innenzehner: 18
 weiteste: 496 (20), 475 (31), 424 (24)
 beste Teiler 85.9 (28.) 92.9 (40.) 109.2 (16.)
 Trefferlage 0.47 mm rechts, 0.84 mm hoch
 Streuwert 1.62, horizontal: 1.80, vertikal: 1.41

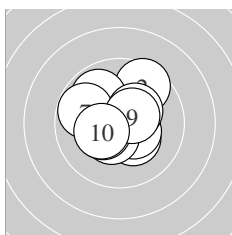
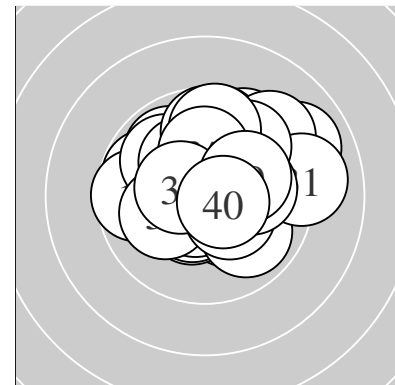

Serie 1:
 10.3 * 9.5 ↗ 9.9 ↘ 10.4 * 10.4 *
 10.4 * 9.8 ↖ 10.3 * 10.5 * 10.3 *
 beste Teiler 117.4 (9.) 126.4 (5.) 131.2 (4.)
 Trefferlage 0.15 mm links, 0.34 mm hoch
 Streuwert 1.52, horizontal: 1.60, vertikal: 1.44

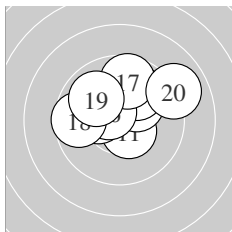

Serie 2:
 10.5 * 10.0 ↑ 10.2 * 10.3 * 9.9 ↗
 10.5 * 9.7 ↑ 9.6 ← 9.9 ↘ 9.0 →
 beste Teiler 109.2 (16.) 114.8 (11.) 175.1 (14.)
 Trefferlage 0.14 mm rechts, 1.30 mm hoch
 Streuwert 1.77, horizontal: 2.17, vertikal: 1.24

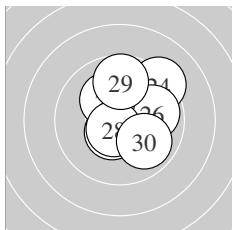

Serie 3:
 10.4 * 10.1 ↑ 10.1 → 9.3 ↗ 10.5 *
 9.9 → 10.2 * 10.6 * 9.7 ↑ 9.9 ↘
 beste Teiler 85.9 (28.) 114.5 (25.) 149.8 (21.)
 Trefferlage 0.89 mm rechts, 0.90 mm hoch
 Streuwert 1.54, horizontal: 1.46, vertikal: 1.62

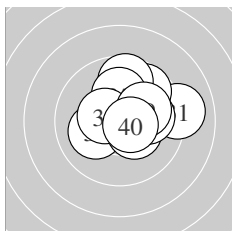

Serie 4:
 9.1 → 9.7 ↗ 10.1 ← 9.7 ↑ 10.1 ↑
 10.4 * 10.1 → 10.5 * 10.1 → 10.6 *
 beste Teiler 92.9 (40.) 125.8 (38.) 146.4 (36.)
 Trefferlage 1.02 mm rechts, 0.82 mm hoch
 Streuwert 1.65, horizontal: 1.88, vertikal: 1.37

Unterschrift des Schützen

Ergebnis: **389** (409.1)
 Serien: 97 96 99 97
 Zähler: 29 11 0 0 0 0 0 0 0 0
 Innenzehner: 27
 weiteste: 446 (12), 411 (31), 410 (8)
 beste Teiler 45.3 (30.) 51.9 (37.) 55.4 (18.)
 Trefferlage 0.78 mm links, 0.27 mm hoch
 Streuwert 1.41, horizontal: 1.66, vertikal: 1.11

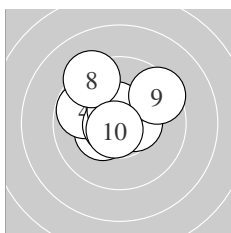
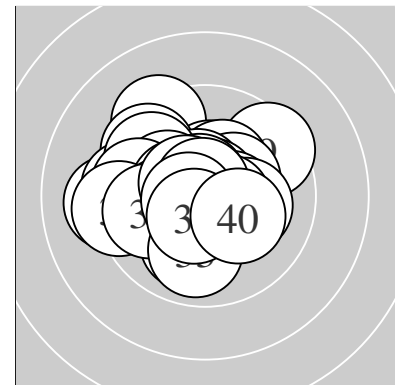

Serie 1:
 10.6 * 10.6 * 10.4 * 9.8 ↖ 10.5 *
 10.7 * 10.5 * 9.3 ↘ 9.5 ↗ 10.7 *
 beste Teiler 64.0 (10.) 69.4 (6.) 81.1 (1.)
 Trefferlage 0.40 mm links, 0.76 mm hoch
 Streuwert 1.47, horizontal: 1.63, vertikal: 1.28

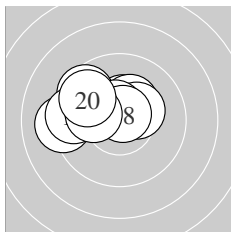

Serie 2:
 10.4 * 9.2 ← 9.6 ↖ 10.3 * 10.3 *
 9.5 ← 10.6 * 10.7 * 10.1 ← 9.7 ↘
 beste Teiler 55.4 (18.) 98.0 (17.) 135.1 (11.)
 Trefferlage 1.30 mm links, 0.92 mm hoch
 Streuwert 1.51, horizontal: 2.02, vertikal: 0.72

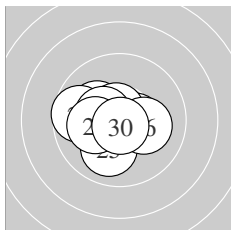

Serie 3:
 10.6 * 10.2 * 10.5 * 10.7 * 10.0 ↙
 10.2 * 9.7 ← 10.4 * 10.2 * 10.8 *
 beste Teiler 45.3 (30.) 74.0 (24.) 80.1 (21.)
 Trefferlage 0.66 mm links, 0.05 mm tief
 Streuwert 1.23, horizontal: 1.50, vertikal: 0.90

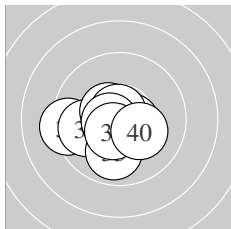

Serie 4:
 9.3 ← 9.9 ← 9.9 ↓ 10.6 * 10.5 *
 10.6 * 10.7 * 10.6 * 10.5 * 10.2 *
 beste Teiler 51.9 (37.) 78.3 (36.) 80.2 (38.)
 Trefferlage 0.77 mm links, 0.53 mm tief
 Streuwert 1.29, horizontal: 1.60, vertikal: 0.89

Unterschrift des Schützen

Ergebnis: **389** (408.4)
 Serien: 97 97 98 97
 Zähler: 31 7 2 0 0 0 0 0 0 0
 Innenzehner: 24
 weiteste: 553 (31), 541 (12), 358 (29)
 beste Teiler 40.3 (33.) 54.4 (39.) 75.1 (1.)
 Trefferlage 0.77 mm rechts, 0.31 mm hoch
 Streuwert 1.46, horizontal: 1.72, vertikal: 1.14

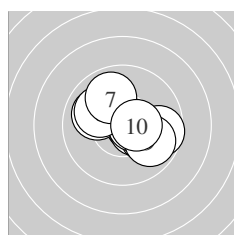
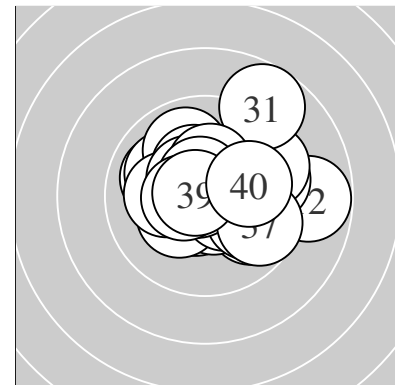

Serie 1:
 10.7 * 10.0 ↖ 10.5 * 10.1 ↘ 10.6 *
 10.0 ↖ 9.9 ↗ 9.7 → 9.9 ↘ 10.5 *
 beste Teiler 75.1 (1.) 96.1 (5.) 118.1 (3.)
 Trefferlage 0.63 mm rechts, 0.12 mm hoch
 Streuwert 1.51, horizontal: 1.82, vertikal: 1.11

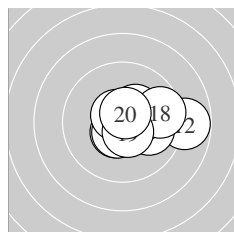

Serie 2:
 10.5 * 8.8 → 10.6 * 10.5 * 10.3 *
 10.6 * 10.0 → 9.6 → 10.6 * 10.6 *
 beste Teiler 82.1 (16.) 82.5 (20.) 94.8 (19.)
 Trefferlage 1.21 mm rechts, 0.07 mm hoch
 Streuwert 1.49, horizontal: 1.94, vertikal: 0.82

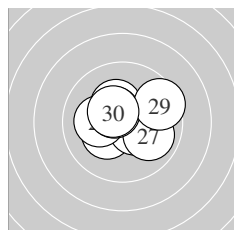

Serie 3:
 10.0 → 10.6 * 10.3 * 10.5 * 10.3 *
 10.1 ← 9.9 ↘ 10.5 * 9.5 → 10.5 *
 beste Teiler 91.5 (22.) 111.3 (28.) 121.5 (24.)
 Trefferlage 0.42 mm rechts, 0.29 mm hoch
 Streuwert 1.43, horizontal: 1.78, vertikal: 0.96

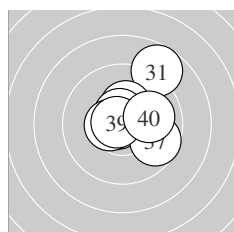

Serie 4:
 8.7 ↗ 10.4 * 10.8 * 10.5 * 10.3 *
 10.6 * 9.7 ↘ 10.5 * 10.7 * 10.0 →
 beste Teiler 40.3 (33.) 54.4 (39.) 89.8 (36.)
 Trefferlage 0.82 mm rechts, 0.78 mm hoch
 Streuwert 1.53, horizontal: 1.48, vertikal: 1.57

Unterschrift des Schützen

Meyton Elektronik

Ergebnis: **372** (392.1)

Serien: 95 96 90 91

Zähler: 14 24 2 0 0 0 0 0 0 0

Innenzehner: 12

weiteste: 628 (30), 572 (26), 487 (6)

beste Teiler 11.4 (28.) 86.3 (11.) 117.1 (2.)

Trefferlage 0.17 mm rechts, 0.15 mm hoch

Streuwert 2.27, horizontal: 2.46, vertikal: 2.06

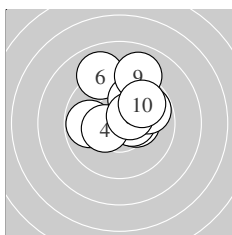
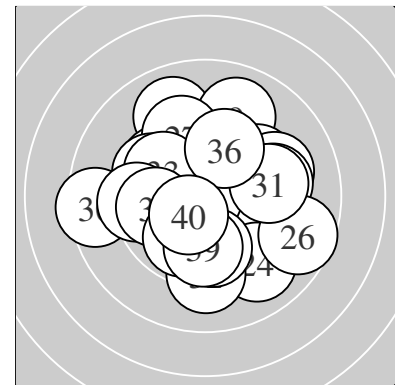

Serie 1:

10.3 *	10.5 *	9.8 ←	10.4 *	9.8 ↗
9.0 ↘	10.0 ↗	10.5 *	9.0 ↗	9.8 ↗

beste Teiler 117.1 (2.) 120.1 (8.) 146.7 (4.)

Trefferlage 0.53 mm rechts, 1.44 mm hoch

Streuwert 1.85, horizontal: 1.86, vertikal: 1.83

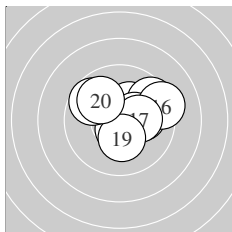

Serie 2:

10.6 *	10.3 *	10.1 →	9.6 ↗	10.4 *
9.3 →	10.2 *	9.7 ↘	10.3 *	9.9 ↘

beste Teiler 86.3 (11.) 146.2 (15.) 166.6 (12.)

Trefferlage 0.89 mm rechts, 0.65 mm hoch

Streuwert 1.67, horizontal: 2.02, vertikal: 1.22

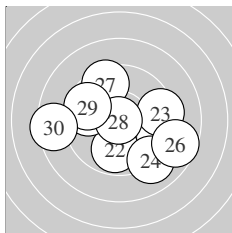

Serie 3:

10.2 *	9.8 ↓	9.4 →	9.0 ↘	9.7 ←
8.7 →	9.5 ↘	10.9 *	9.6 ↘	8.4 ←

beste Teiler 11.4 (28.) 198.6 (21.) 276.5 (22.)

Trefferlage 0.09 mm links, 0.48 mm tief

Streuwert 2.92, horizontal: 3.52, vertikal: 2.16

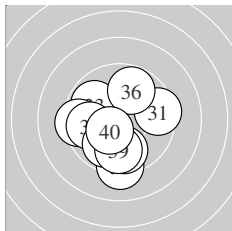

Serie 4:

9.5 →	9.2 ↓	9.8 ↘	9.4 ←	9.8 ←
9.8 ↗	9.8 ↓	9.9 ↙	9.8 ↓	10.4 *

beste Teiler 143.1 (40.) 268.0 (38.) 276.1 (33.)

Trefferlage 0.62 mm links, 0.98 mm tief

Streuwert 2.18, horizontal: 2.16, vertikal: 2.21

Unterschrift des Schützen

Ergebnis:	395	(413.7)
Serien:	98	100 98 99
Zähler:	35 5 0 0 0 0 0 0 0 0	
Innenzehner:	30	
weiteste:	382 (39), 366 (22), 329 (30)	
beste Teiler	16.6 (29.) 17.0 (10.) 26.5 (21.)	
Trefferlage	0.32 mm rechts, 0.30 mm hoch	
Streuwert	1.24, horizontal: 1.49, vertikal: 0.93	

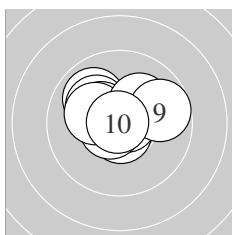
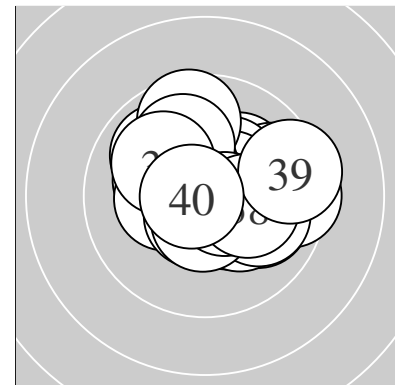

Serie 1:

9.9 ↘	10.7 *	10.1 ↘	10.8 *	10.7 *
10.3 *	10.2 *	10.2 *	9.7 →	10.9 *
beste Teiler	17.0 (10.) 48.0 (4.) 66.6 (2.)			
Trefferlage	0.25 mm links, 0.59 mm hoch			
Streuwert	1.22, horizontal: 1.55, vertikal: 0.78			

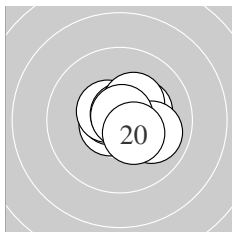

Serie 2:

10.7 *	10.6 *	10.5 *	10.4 *	10.8 *
10.3 *	10.3 *	10.0 →	10.8 *	10.4 *
beste Teiler	35.7 (19.) 45.8 (15.) 75.5 (11.)			
Trefferlage	0.52 mm rechts, 0.16 mm hoch			
Streuwert	0.90, horizontal: 1.07, vertikal: 0.69			

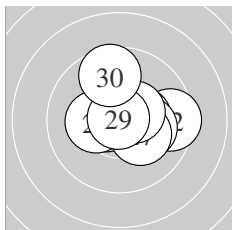

Serie 3:

10.8 *	9.5 →	10.4 *	10.2 *	10.6 *
10.3 *	10.2 *	10.5 *	10.9 *	9.6 ↑
beste Teiler	16.6 (29.) 26.5 (21.) 95.0 (25.)			
Trefferlage	0.64 mm rechts, 0.24 mm hoch			
Streuwert	1.38, horizontal: 1.59, vertikal: 1.13			

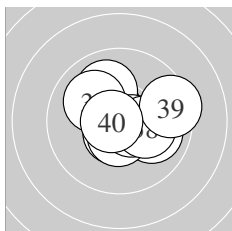

Serie 4:

10.0 →	10.4 *	10.6 *	10.0 ↑	10.0 ↘
10.5 *	10.6 *	10.2 *	9.4 →	10.7 *
beste Teiler	58.0 (40.) 91.9 (37.) 94.8 (33.)			
Trefferlage	0.40 mm rechts, 0.23 mm hoch			
Streuwert	1.46, horizontal: 1.72, vertikal: 1.13			

Unterschrift des Schützen

Ergebnis:	385	(402.6)
Serien:	96 95 95 99	
Zähler:	27 11 2 0 0 0 0 0 0 0	
Innenzehner:	18	
weiteste:	574 (4), 514 (13), 440 (16)	
beste Teiler	38.0 (36.) 61.4 (38.) 68.7 (18.)	
Trefferlage	0.37 mm links, 0.38 mm hoch	
Streuwert	1.77, horizontal: 1.95, vertikal: 1.56	

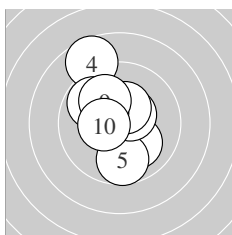
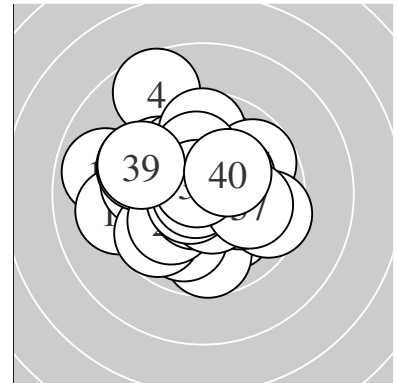

Serie 1:

10.1 ↘	10.6 *	10.5 *	8.7 ↗	9.7 ↓
10.5 *	9.8 ↘	10.4 *	10.0 ↗	10.4 *
beste Teiler	78.4 (2.) 116.8 (6.) 120.0 (3.)			
Trefferlage	0.59 mm links, 0.66 mm hoch			
Streuwert	1.83, horizontal: 1.31, vertikal: 2.22			

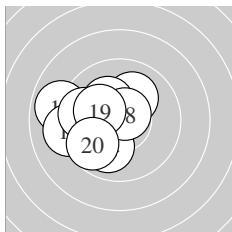

Serie 2:

10.1 ↙	10.1 ↗	8.9 ←	10.0 ↓	10.2 *
9.2 ←	9.7 ←	10.7 *	10.2 *	9.7 ↙
beste Teiler	68.7 (18.) 181.3 (15.) 189.6 (19.)			
Trefferlage	1.85 mm links, 0.00 mm			
Streuwert	1.71, horizontal: 1.92, vertikal: 1.48			

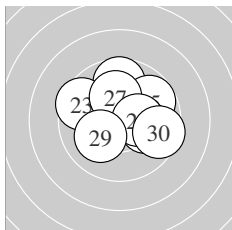

Serie 3:

10.3 *	9.7 ↑	9.5 ↘	9.9 ↗	9.8 ↗
10.0 →	10.1 ↑	10.3 *	10.1 ↙	9.5 →
beste Teiler	155.3 (21.) 157.0 (28.) 202.0 (27.)			
Trefferlage	0.70 mm rechts, 0.78 mm hoch			
Streuwert	1.80, horizontal: 2.08, vertikal: 1.47			

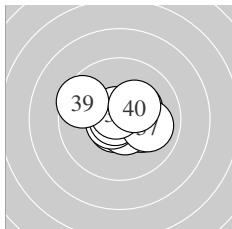

Serie 4:

10.7 *	10.2 *	10.6 *	10.7 *	10.3 *
10.8 *	10.0 →	10.7 *	9.6 ↘	10.3 *
beste Teiler	38.0 (36.) 61.4 (38.) 73.3 (34.)			
Trefferlage	0.24 mm rechts, 0.10 mm hoch			
Streuwert	1.28, horizontal: 1.61, vertikal: 0.82			

Unterschrift des Schützen

Ergebnis: **394** (413.1)
 Serien: 98 100 96 100
 Zähler: 34 6 0 0 0 0 0 0 0 0
 Innenzehner: 33
 weiteste: 344 (25), 336 (22), 306 (30)
 beste Teiler 46.4 (3.) 50.4 (18.) 63.3 (20.)
 Trefferlage 0.04 mm links, 0.05 mm tief
 Streuwert 1.24, horizontal: 1.26, vertikal: 1.22

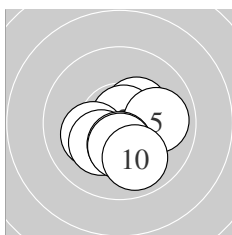
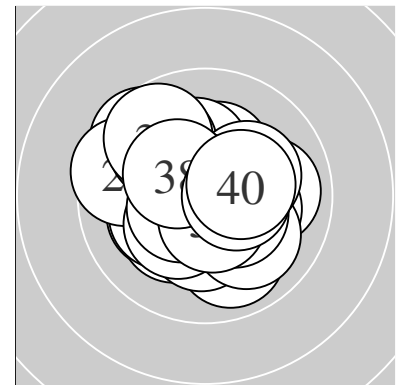

Serie 1:
 10.5 * 10.4 * 10.8 * 10.3 * 9.9 →
 10.2 * 10.2 * 10.4 * 10.3 * 9.9 ↓
 beste Teiler 46.4 (3.) 116.3 (1.) 146.0 (8.)
 Trefferlage 0.31 mm rechts, 0.84 mm tief
 Streuwert 1.13, horizontal: 1.23, vertikal: 1.03

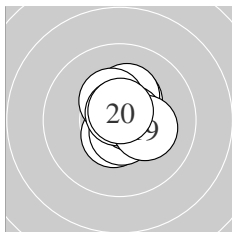

Serie 2:
 10.4 * 10.3 * 10.7 * 10.5 * 10.4 *
 10.6 * 10.6 * 10.8 * 10.2 * 10.7 *
 beste Teiler 50.4 (18.) 63.3 (20.) 72.9 (13.)
 Trefferlage 0.33 mm rechts, 0.26 mm hoch
 Streuwert 0.83, horizontal: 0.67, vertikal: 0.97

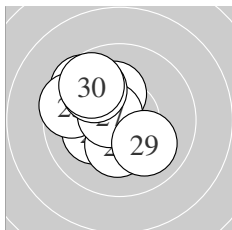

Serie 3:
 10.5 * 9.6 ↖ 10.2 * 10.2 * 9.6 ↖
 10.3 * 10.7 * 9.9 ↖ 10.0 ↓ 9.7 ↖
 beste Teiler 75.1 (27.) 110.0 (21.) 168.6 (26.)
 Trefferlage 1.06 mm links, 0.47 mm hoch
 Streuwert 1.55, horizontal: 1.45, vertikal: 1.64

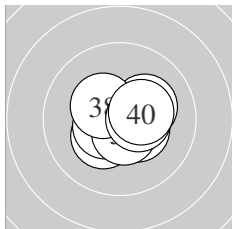

Serie 4:
 10.3 * 10.2 * 10.4 * 10.6 * 10.6 *
 10.5 * 10.6 * 10.4 * 10.4 * 10.3 *
 beste Teiler 81.8 (35.) 90.9 (34.) 96.1 (37.)
 Trefferlage 0.24 mm rechts, 0.12 mm tief
 Streuwert 0.98, horizontal: 1.15, vertikal: 0.78

Unterschrift des Schützen

Ergebnis: **382** (402.6)
 Serien: 93 96 95 98
 Zähler: 23 16 1 0 0 0 0 0 0 0
 Innenzehner: 18
 weiteste: 517 (2), 424 (15), 424 (23)
 beste Teiler 26.0 (22.) 27.0 (31.) 60.9 (19.)
 Trefferlage 0.37 mm rechts, 0.50 mm hoch
 Streuwert 1.75, horizontal: 1.91, vertikal: 1.58

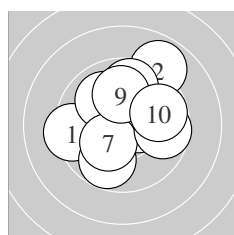
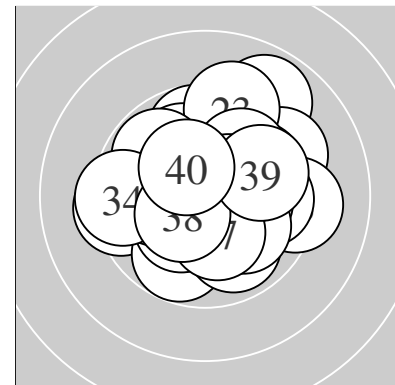

Serie 1:
 9.4 ← 8.9 ↗ 9.8 ↘ 9.7 ↑ 10.0 ↖
 10.5 * 10.3 * 9.7 → 10.0 ↑ 9.8 →
 beste Teiler 123.3 (6.) 174.0 (7.) 241.3 (9.)
 Trefferlage 0.26 mm rechts, 0.77 mm hoch
 Streuwert 2.22, horizontal: 2.29, vertikal: 2.16

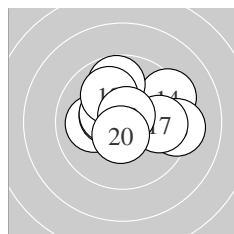

Serie 2:
 10.1 ← 10.4 * 10.4 * 9.4 ↗ 9.3 →
 9.8 ↑ 9.8 → 10.0 ↖ 10.7 * 10.6 *
 beste Teiler 60.9 (19.) 99.1 (20.) 126.7 (12.)
 Trefferlage 0.46 mm rechts, 0.70 mm hoch
 Streuwert 1.82, horizontal: 2.25, vertikal: 1.25

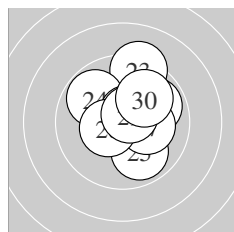

Serie 3:
 9.9 ↗ 10.8 * 9.3 ↑ 9.8 ↖ 9.9 ↘
 10.7 * 10.2 * 10.5 * 10.6 * 9.9 ↗
 beste Teiler 26.0 (22.) 75.4 (26.) 82.8 (29.)
 Trefferlage 0.60 mm rechts, 0.72 mm hoch
 Streuwert 1.57, horizontal: 1.43, vertikal: 1.70

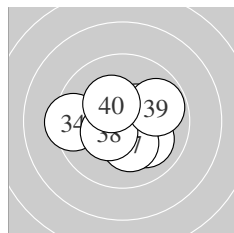

Serie 4:
 10.8 * 10.5 * 10.4 * 9.4 ← 10.0 ↖
 10.6 * 10.2 * 10.4 * 9.8 → 10.3 *
 beste Teiler 27.0 (31.) 78.3 (36.) 120.4 (32.)
 Trefferlage 0.18 mm rechts, 0.17 mm tief
 Streuwert 1.47, horizontal: 1.82, vertikal: 1.00

Unterschrift des Schützen

Meyton Elektronik

Ergebnis: **396** (413.1)
 Serien: 100 99 99 98
 Zähler: 36 4 0 0 0 0 0 0 0 0
 Innenzehner: 32
 weiteste: 359 (20), 293 (30), 287 (36)
 beste Teiler 57.2 (10.) 60.5 (28.) 67.2 (33.)
 Trefferlage 0.13 mm links, 0.12 mm hoch
 Streuwert 1.21, horizontal: 1.31, vertikal: 1.09

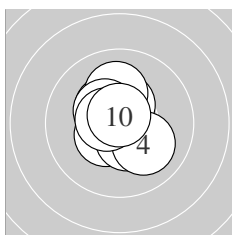
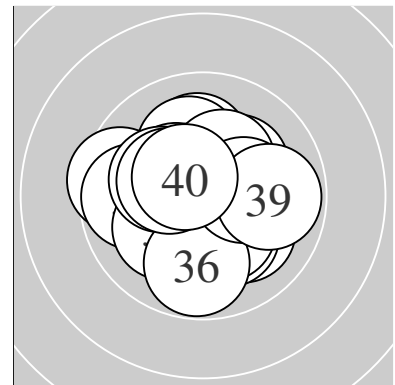

Serie 1:
 10.4 * 10.4 * 10.5 * 10.1 ↘ 10.4 *
 10.3 * 10.1 ↑ 10.4 * 10.6 * 10.7 *
 beste Teiler 57.2 (10.) 94.6 (9.) 124.3 (3.)
 Trefferlage 0.20 mm links, 0.45 mm hoch
 Streuwert 1.06, horizontal: 0.86, vertikal: 1.22

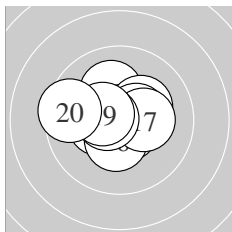

Serie 2:
 10.6 * 10.1 ↑ 10.2 * 10.5 * 10.4 *
 10.4 * 10.3 * 10.6 * 10.4 * 9.5 ←
 beste Teiler 82.8 (11.) 88.5 (18.) 122.4 (14.)
 Trefferlage 0.30 mm links, 0.21 mm hoch
 Streuwert 1.30, horizontal: 1.60, vertikal: 0.91

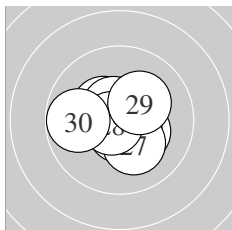

Serie 3:
 10.3 * 10.6 * 10.4 * 10.5 * 10.6 *
 10.6 * 10.2 * 10.7 * 10.2 * 9.8 ←
 beste Teiler 60.5 (28.) 77.0 (22.) 88.5 (26.)
 Trefferlage 0.00 mm , 0.01 mm tief
 Streuwert 1.16, horizontal: 1.34, vertikal: 0.93

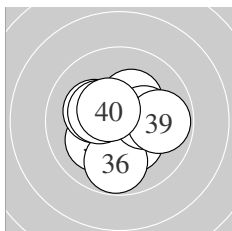

Serie 4:
 10.3 * 10.1 ↙ 10.7 * 10.2 * 10.3 *
 9.8 ↓ 10.3 * 10.3 * 9.8 → 10.5 *
 beste Teiler 67.2 (33.) 111.7 (40.) 156.6 (37.)
 Trefferlage 0.02 mm links, 0.14 mm tief
 Streuwert 1.42, horizontal: 1.52, vertikal: 1.31

Unterschrift des Schützen

Meyton Elektronik

Ergebnis: **375** (392.7)
 Serien: 97 91 93 94
 Zähler: 20 15 5 0 0 0 0 0 0 0
 Innenzehner: 13
 weiteste: 629 (18), 559 (27), 534 (12)
 beste Teiler 41.6 (22.) 55.0 (36.) 65.0 (25.)
 Trefferlage 0.39 mm links, 0.25 mm hoch
 Streuwert 2.27, horizontal: 2.62, vertikal: 1.86

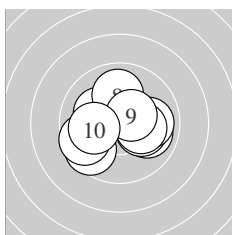
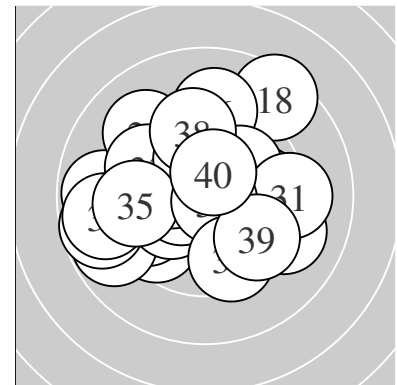

Serie 1:
 9.9 → 9.6 ↙ 10.1 → 10.0 → 9.6 ←
 10.2 * 10.2 * 10.0 ↑ 10.5 * 10.0 ←
 beste Teiler 122.5 (9.) 191.4 (7.) 198.5 (6.)
 Trefferlage 0.00 mm , 0.19 mm tief
 Streuwert 1.82, horizontal: 2.21, vertikal: 1.31

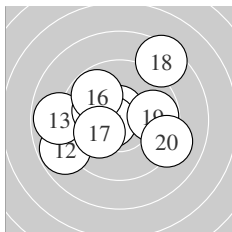

Serie 2:
 10.6 * 8.8 ↙ 8.8 ← 10.1 ↖ 10.6 *
 9.8 ↘ 10.1 ↙ 8.4 ↗ 9.8 → 9.2 →
 beste Teiler 77.2 (15.) 78.6 (11.) 204.9 (17.)
 Trefferlage 0.58 mm links, 0.39 mm hoch
 Streuwert 2.77, horizontal: 3.27, vertikal: 2.15

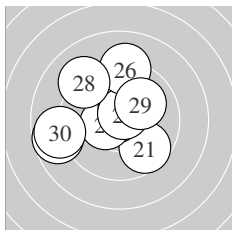

Serie 3:
 9.7 ↘ 10.8 * 10.4 * 10.5 * 10.7 *
 9.2 ↑ 8.7 ← 9.1 ↘ 10.0 ↗ 8.8 ←
 beste Teiler 41.6 (22.) 65.0 (25.) 112.2 (24.)
 Trefferlage 1.00 mm links, 0.57 mm hoch
 Streuwert 2.43, horizontal: 2.70, vertikal: 2.11

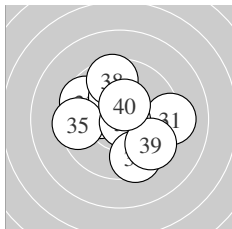

Serie 4:
 9.2 → 10.2 * 9.6 ↖ 10.2 * 9.5 ←
 10.7 * 9.5 ↘ 9.6 ↑ 9.6 ↘ 10.4 *
 beste Teiler 55.0 (36.) 130.2 (40.) 178.6 (32.)
 Trefferlage 0.00 mm , 0.24 mm hoch
 Streuwert 2.22, horizontal: 2.47, vertikal: 1.95

Unterschrift des Schützen

Ergebnis: **396** (413.7)
 Serien: 99 99 98 100
 Zähler: 36 4 0 0 0 0 0 0 0 0
 Innenzehner: 31
 weiteste: 392 (22), 383 (8), 351 (21)
 beste Teiler 8.6 (11.) 24.3 (26.) 36.1 (16.)
 Trefferlage 0.40 mm links, 0.43 mm hoch
 Streuwert 1.19, horizontal: 1.35, vertikal: 1.00

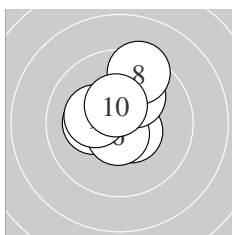
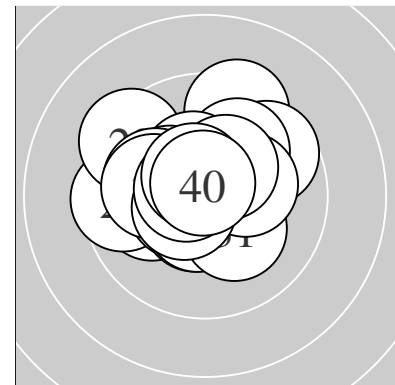

Serie 1:
 10.2 * 10.5 * 10.4 * 10.5 * 10.6 *
 10.6 * 10.1 ↗ 9.4 ↗ 10.2 * 10.4 *
 beste Teiler 76.5 (5.) 76.9 (6.) 101.2 (4.)
 Trefferlage 0.14 mm links, 0.84 mm hoch
 Streuwert 1.20, horizontal: 1.12, vertikal: 1.27

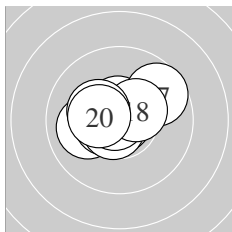

Serie 2:
 10.9 * 10.0 ← 10.5 * 10.6 * 10.7 *
 10.8 * 9.7 ↗ 10.4 * 10.3 * 10.4 *
 beste Teiler 8.6 (11.) 36.1 (16.) 72.4 (15.)
 Trefferlage 0.33 mm links, 0.30 mm hoch
 Streuwert 1.13, horizontal: 1.42, vertikal: 0.74

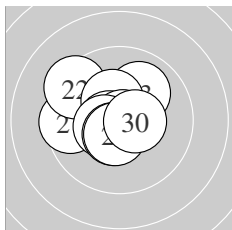

Serie 3:
 9.5 ← 9.4 ↖ 10.0 ↗ 10.4 * 10.6 *
 10.9 * 10.5 * 10.5 * 10.5 * 10.5 *
 beste Teiler 24.3 (26.) 76.6 (25.) 104.9 (29.)
 Trefferlage 0.70 mm links, 0.27 mm hoch
 Streuwert 1.40, horizontal: 1.59, vertikal: 1.18

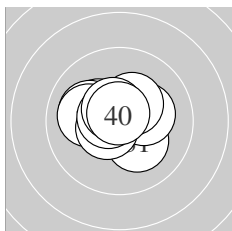

Serie 4:
 10.2 * 10.2 * 10.3 * 10.4 * 10.1 ↖
 10.1 ← 10.5 * 10.6 * 10.6 * 10.7 *
 beste Teiler 55.9 (40.) 85.0 (38.) 98.4 (39.)
 Trefferlage 0.42 mm links, 0.33 mm hoch
 Streuwert 1.10, horizontal: 1.37, vertikal: 0.75

Unterschrift des Schützen

Meyton Elektronik

Ergebnis: **331** (348.7)
 Serien: 77 90 85 79
 Zähler: 6 15 9 6 2 2 0 0 0 0
 Innenzehner: 2
 weiteste: 1365 (37), 1293 (8), 1227 (3)
 beste Teiler 31.6 (10.) 191.5 (30.) 204.4 (4.)
 Trefferlage 2.39 mm rechts, 1.54 mm hoch
 Streuwert 4.13, horizontal: 5.16, vertikal: 2.73

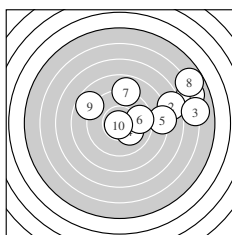
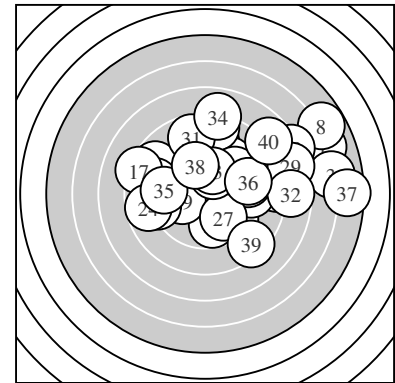

Serie 1:
 6.1 → 7.5 → 6.0 → 10.1 ↘ 8.2 →
 9.6 → 8.9 ↑ 5.8 ↗ 8.7 ↖ 10.8 *
 beste Teiler 31.6 (10.) 204.4 (4.) 327.7 (6.)
 Trefferlage 5.06 mm rechts, 2.31 mm hoch
 Streuwert 4.42, horizontal: 5.73, vertikal: 2.50

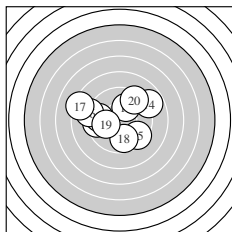

Serie 2:
 10.0 ↑ 9.5 ← 9.6 ← 8.8 ↗ 9.5 ↘
 9.0 ← 8.3 ← 9.7 ↓ 10.0 ← 9.4 ↗
 beste Teiler 227.4 (19.) 227.6 (11.) 301.0 (18.)
 Trefferlage 0.87 mm links, 0.53 mm hoch
 Streuwert 3.01, horizontal: 3.68, vertikal: 2.13

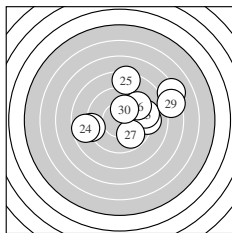

Serie 3:
 9.2 → 9.1 ← 9.3 → 8.7 ← 8.4 ↑
 9.5 ↗ 9.8 ↘ 7.2 ↗ 7.5 → 10.2 *
 beste Teiler 191.5 (30.) 284.8 (27.) 365.6 (26.)
 Trefferlage 2.15 mm rechts, 1.37 mm hoch
 Streuwert 3.77, horizontal: 4.60, vertikal: 2.70

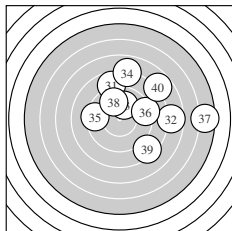

Serie 4:
 8.7 ↑ 7.7 → 10.0 ↑ 7.9 ↑ 9.4 ←
 9.2 → 5.5 → 9.8 ↓ 8.3 ↘ 7.8 ↗
 beste Teiler 233.3 (33.) 289.6 (38.) 395.6 (35.)
 Trefferlage 3.23 mm rechts, 1.98 mm hoch
 Streuwert 4.43, horizontal: 5.21, vertikal: 3.47

Unterschrift des Schützen

Meyton Elektronik

Ergebnis: **394** (412.8)
 Serien: 99 99 98 98
 Zähler: 34 6 0 0 0 0 0 0 0 0
 Innenzehner: 29
 weiteste: 344 (39), 326 (22), 312 (38)
 beste Teiler 20.6 (11.) 28.6 (3.) 30.6 (12.)
 Trefferlage 0.20 mm rechts, 0.22 mm tief
 Streuwert 1.25, horizontal: 1.43, vertikal: 1.04

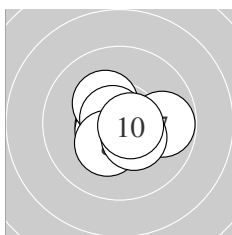
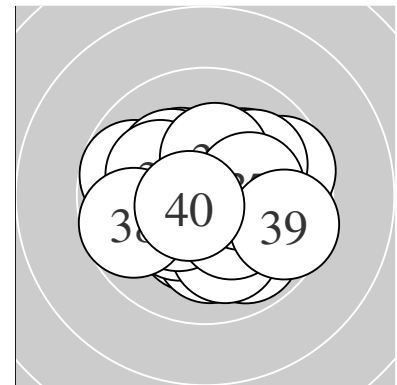

Serie 1:
 10.6 * 10.6 * 10.8 * 10.6 * 10.3 *
 10.7 * 9.8 → 10.3 * 10.4 * 10.6 *
 beste Teiler 28.6 (3.) 57.6 (6.) 77.1 (10.)
 Trefferlage 0.17 mm rechts, 0.23 mm tief
 Streuwert 1.01, horizontal: 1.22, vertikal: 0.75

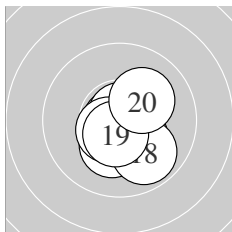

Serie 2:
 10.9 * 10.8 * 10.5 * 10.8 * 10.3 *
 10.3 * 10.6 * 9.9 ↘ 10.6 * 10.1 ↗
 beste Teiler 20.6 (11.) 30.6 (12.) 34.2 (14.)
 Trefferlage 0.30 mm rechts, 0.58 mm tief
 Streuwert 0.94, horizontal: 0.84, vertikal: 1.03

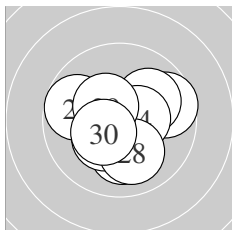

Serie 3:
 10.4 * 9.6 → 10.0 ↗ 10.5 * 10.1 ↓
 9.7 ← 10.3 * 10.0 ↓ 10.4 * 10.4 *
 beste Teiler 123.4 (24.) 126.3 (21.) 134.3 (29.)
 Trefferlage 0.25 mm rechts, 0.18 mm tief
 Streuwert 1.55, horizontal: 1.76, vertikal: 1.31

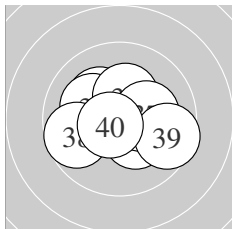

Serie 4:
 10.6 * 10.2 * 10.1 ↘ 10.3 * 10.3 *
 10.3 * 10.2 * 9.7 ← 9.6 → 10.6 *
 beste Teiler 76.0 (40.) 80.9 (31.) 154.0 (36.)
 Trefferlage 0.10 mm rechts, 0.10 mm hoch
 Streuwert 1.51, horizontal: 1.88, vertikal: 1.03

Unterschrift des Schützen

Meyton Elektronik

Ergebnis:	380	(396.7)
Serien:	90 99 96 95	
Zähler:	23 14 3 0 0 0 0 0 0 0	
Innenzehner:	16	
weiteste:	657 (2), 547 (5), 527 (8)	
beste Teiler	56.6 (12.) 67.1 (33.) 118.2 (30.)	
Trefferlage	0.37 mm rechts, 0.36 mm hoch	
Streuwert	2.05, horizontal: 2.19, vertikal: 1.89	

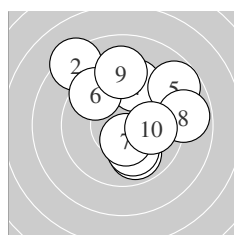
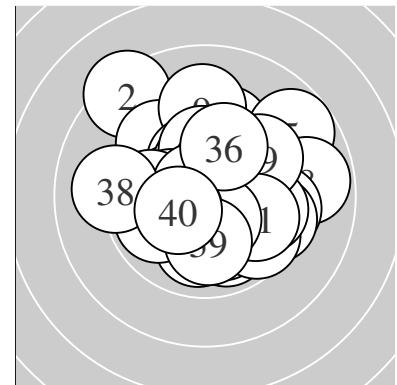

Serie 1:

9.9 ↘	8.3 ↖	10.0 ↘	9.5 ↑	8.8 ↗
9.5 ↖	10.4 *	8.8 →	9.1 ↑	10.0 →
beste Teiler	128.3 (7.)	228.0 (3.)	244.1 (10.)	
Trefferlage	0.89 mm rechts, 1.38 mm hoch			
Streuwert	2.79, horizontal: 2.78, vertikal: 2.80			

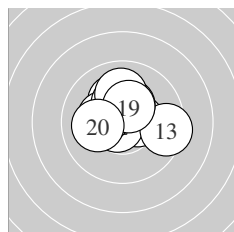

Serie 2:

10.4 *	10.7 *	9.4 →	10.2 *	10.3 *
10.3 *	10.3 *	10.0 ↑	10.4 *	10.1 ←
beste Teiler	56.6 (12.)	130.6 (11.)	142.8 (19.)	
Trefferlage	0.05 mm rechts, 0.78 mm hoch			
Streuwert	1.38, horizontal: 1.64, vertikal: 1.06			

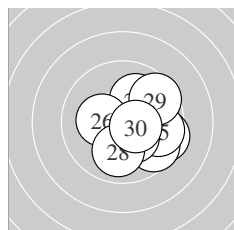

Serie 3:

10.5 *	10.1 ↗	9.5 →	9.6 ↘	9.7 →
10.3 *	10.3 *	10.0 ↓	9.6 ↗	10.5 *
beste Teiler	118.2 (30.)	125.0 (21.)	156.2 (27.)	
Trefferlage	1.40 mm rechts, 0.31 mm tief			
Streuwert	1.58, horizontal: 1.65, vertikal: 1.52			

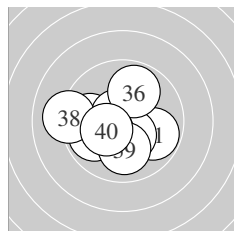

Serie 4:

9.8 →	9.8 ←	10.7 *	10.4 *	10.3 *
9.9 ↑	9.9 ←	9.1 ←	10.0 ↓	10.3 *
beste Teiler	67.1 (33.)	137.3 (34.)	155.0 (35.)	
Trefferlage	0.86 mm links, 0.38 mm tief			
Streuwert	1.76, horizontal: 2.09, vertikal: 1.33			

Unterschrift des Schützen

Meyton Elektronik

Ergebnis: **372** (387.9)
 Serien: 91 94 94 93
 Zähler: 19 14 7 0 0 0 0 0 0
 Innenzehner: 12
 weiteste: 734 (10), 727 (17), 667 (36)
 beste Teiler 53.0 (34.) 56.7 (30.) 57.6 (16.)
 Trefferlage 0.29 mm rechts, 0.07 mm hoch
 Streuwert 2.60, horizontal: 2.95, vertikal: 2.19

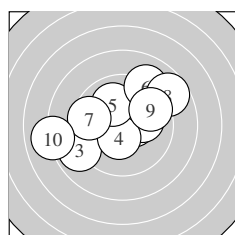
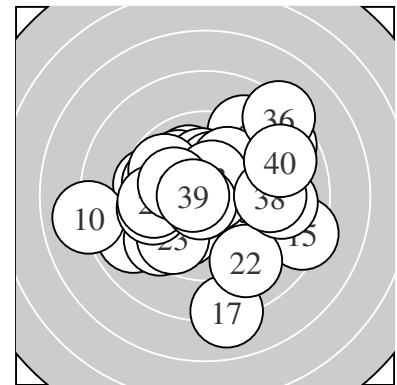

Serie 1:
 10.5 * 10.1 → 8.9 ↙ 10.4 * 10.0 ↘
 9.1 ↗ 9.5 ← 8.7 ↗ 9.6 ↗ 8.0 ←
 beste Teiler 116.0 (1.) 133.9 (4.) 209.1 (2.)
 Trefferlage 0.33 mm links, 0.69 mm hoch
 Streuwert 3.02, horizontal: 3.73, vertikal: 2.07

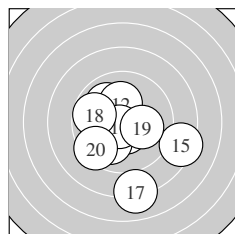

Serie 2:
 10.0 ↘ 10.2 * 10.5 * 10.0 ↙ 8.4 →
 10.7 * 8.0 ↓ 9.7 ← 10.1 → 9.4 ↙
 beste Teiler 57.6 (16.) 111.6 (13.) 196.1 (12.)
 Trefferlage 0.05 mm rechts, 1.17 mm tief
 Streuwert 2.65, horizontal: 2.64, vertikal: 2.66

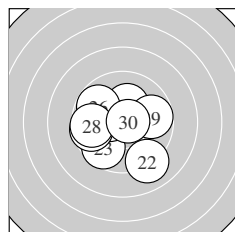

Serie 3:
 10.6 * 9.1 ↘ 9.6 ↙ 10.4 * 10.2 *
 9.8 ↘ 9.6 ← 9.7 ← 9.7 → 10.7 *
 beste Teiler 56.7 (30.) 100.2 (21.) 132.1 (24.)
 Trefferlage 0.66 mm links, 0.36 mm tief
 Streuwert 2.01, horizontal: 2.23, vertikal: 1.77

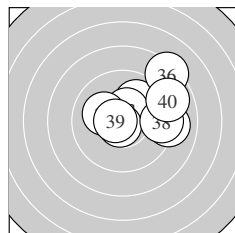

Serie 4:
 9.2 → 10.0 ↗ 10.4 * 10.7 * 10.1 ↘
 8.3 ↗ 9.1 → 9.3 → 10.7 * 8.9 →
 beste Teiler 53.0 (34.) 75.0 (39.) 126.1 (33.)
 Trefferlage 2.10 mm rechts, 1.15 mm hoch
 Streuwert 2.17, horizontal: 2.60, vertikal: 1.61

Unterschrift des Schützen

Ergebnis:	343	(360.5)
Serien:	85	81 90 87
Zähler:	5	19 11 4 1 0 0 0 0 0
Innenzehner:	3	
weiteste:	1009 (19),	985 (7), 956 (14)
beste Teiler	149.2 (24.)	163.5 (25.) 184.2 (16.)
Trefferlage	1.85 mm rechts, 1.04 mm hoch	
Streuwert	3.53, horizontal: 4.25, vertikal: 2.61	

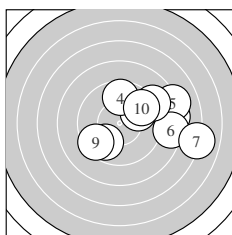
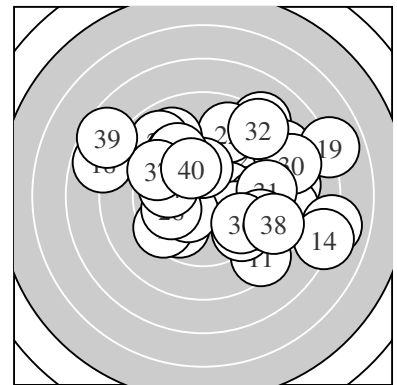

Serie 1:	9.8 ↙	8.3 →	9.9 ↗	9.7 ↑	8.1 →
	8.4 →	7.0 →	9.0 ↗	9.4 ↙	9.6 ↗
beste Teiler	264.0 (3.) 294.4 (1.) 322.1 (4.)				
Trefferlage	3.36 mm rechts, 0.45 mm hoch				
Streuwert	3.26, horizontal: 4.05, vertikal: 2.20				

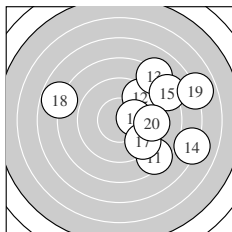

Serie 2:	8.5 ↘	9.4 ↗	8.2 ↗	7.1 →	8.2 ↗
	10.2 *	9.4 ↘	7.8 ←	6.9 →	9.3 →
beste Teiler	184.2 (16.) 386.0 (12.) 390.0 (17.)				
Trefferlage	3.67 mm rechts, 0.75 mm hoch				
Streuwert	4.07, horizontal: 4.68, vertikal: 3.36				

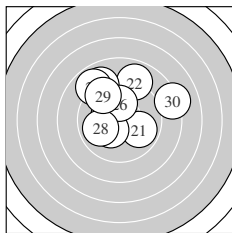

Serie 3:	9.9 ↘	8.9 ↑	9.0 ↘	10.4 *	10.3 *
	10.1 ↑	8.9 ↘	9.9 ←	9.5 ↘	8.2 →
beste Teiler	149.2 (24.) 163.5 (25.) 209.0 (26.)				
Trefferlage	0.15 mm links, 1.81 mm hoch				
Streuwert	2.69, horizontal: 3.00, vertikal: 2.34				

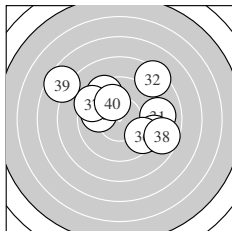

Serie 4:	9.0 →	8.4 ↗	9.5 ↘	9.9 ←	9.1 →
	9.5 ↘	9.4 ↘	8.7 →	7.6 ↘	10.1 ↘
beste Teiler	224.4 (40.) 265.8 (34.) 351.3 (36.)				
Trefferlage	0.53 mm rechts, 1.16 mm hoch				
Streuwert	3.54, horizontal: 4.28, vertikal: 2.59				

Unterschrift des Schützen

Meyton Elektronik

Ergebnis:	384	(402.3)
Serien:	97 94 95 98	
Zähler:	26 12 2 0 0 0 0 0 0 0	
Innenzehner:	20	
weiteste:	543 (22), 534 (10), 450 (17)	
beste Teiler	38.3 (30.) 44.0 (11.) 69.4 (37.)	
Trefferlage	0.27 mm rechts, 0.49 mm tief	
Streuwert	1.79, horizontal: 1.87, vertikal: 1.70	

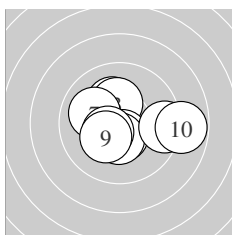
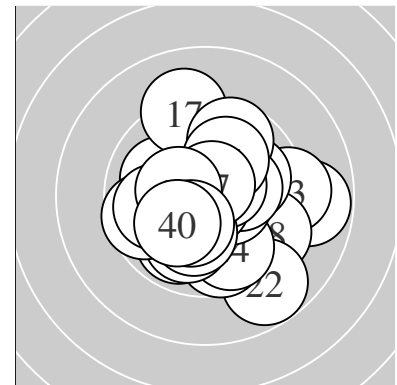

Serie 1:	10.3 *	10.2 *	10.3 *	10.5 *	10.4 *
	9.4 →	10.0 ↖	10.4 *	10.3 *	8.8 →
beste Teiler	109.8 (4.) 127.8 (8.) 133.1 (5.)				
Trefferlage	0.27 mm rechts, 0.02 mm hoch				
Streuwert	1.91, horizontal: 2.42, vertikal: 1.20				

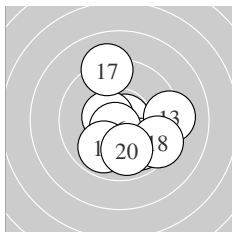

Serie 2:	10.8 *	9.9 ↘	9.2 →	10.1 ↓	10.5 *
	10.6 *	9.2 ↑	9.4 ↘	9.9 ↙	9.9 ↓
beste Teiler	44.0 (11.) 81.0 (16.) 106.7 (15.)				
Trefferlage	0.67 mm rechts, 0.68 mm tief				
Streuwert	2.01, horizontal: 1.91, vertikal: 2.10				

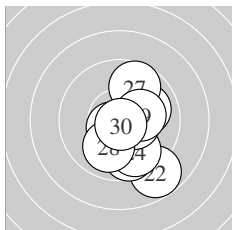

Serie 3:	10.0 →	8.8 ↘	9.7 ↓	9.8 ↘	10.6 *
	10.4 *	9.7 ↑	10.0 ↓	10.2 *	10.8 *
beste Teiler	38.3 (30.) 92.6 (25.) 129.5 (26.)				
Trefferlage	1.03 mm rechts, 0.95 mm tief				
Streuwert	1.77, horizontal: 1.25, vertikal: 2.17				

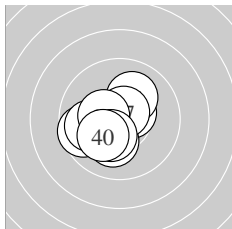

Serie 4:	9.6 ←	10.5 *	10.2 *	10.1 ↗	10.4 *
	9.9 ←	10.7 *	10.4 *	10.3 *	10.1 ↙
beste Teiler	69.4 (37.) 110.2 (32.) 127.2 (35.)				
Trefferlage	0.86 mm links, 0.35 mm tief				
Streuwert	1.28, horizontal: 1.38, vertikal: 1.17				

Unterschrift des Schützen

Meyton Elektronik

Ergebnis: **340** (358.3)
 Serien: 89 86 82 83
 Zähler: 9 15 7 6 2 1 0 0 0 0
 Innenzehner: 7
 weiteste: 1305 (15), 1061 (32), 1023 (24)
 beste Teiler 52.3 (17.) 95.0 (35.) 113.1 (4.)
 Trefferlage 1.78 mm links, 0.53 mm tief
 Streuwert 3.94, horizontal: 4.77, vertikal: 2.87

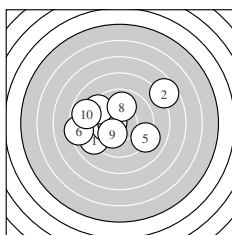
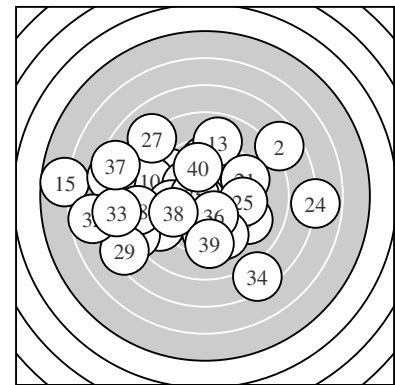

Serie 1:
 9.1 ↙ 7.6 ↗ 10.1 ← 10.5 * 9.1 ↘
 8.4 ← 9.4 ↘ 9.9 ↑ 10.2 * 8.8 ←
 beste Teiler 113.1 (4.) 193.3 (9.) 216.3 (3.)
 Trefferlage 1.17 mm links, 0.27 mm hoch
 Streuwert 3.31, horizontal: 4.06, vertikal: 2.33

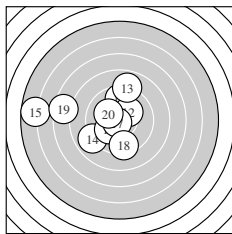

Serie 2:
 9.6 ↑ 10.2 * 8.9 ↑ 8.9 ↙ 5.7 ←
 10.1 ↙ 10.7 * 9.4 ↓ 7.4 ← 10.2 *
 beste Teiler 52.3 (17.) 184.7 (12.) 199.9 (20.)
 Trefferlage 2.63 mm links, 0.51 mm hoch
 Streuwert 3.85, horizontal: 4.72, vertikal: 2.70

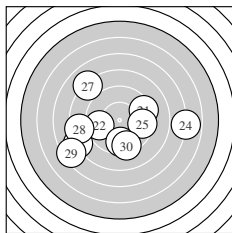

Serie 3:
 9.3 → 9.7 ← 8.0 ↙ 6.9 → 9.5 →
 9.6 ↓ 8.1 ↘ 8.4 ← 7.4 ↙ 9.3 ↓
 beste Teiler 321.1 (22.) 335.2 (26.) 355.2 (25.)
 Trefferlage 0.95 mm links, 1.24 mm tief
 Streuwert 4.57, horizontal: 5.70, vertikal: 3.05

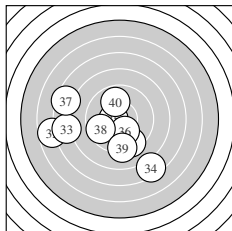

Serie 4:
 9.3 ↓ 6.7 ← 7.6 ← 7.4 ↓ 10.6 *
 10.2 * 7.4 ↘ 9.6 ↙ 9.2 ↓ 9.9 ↑
 beste Teiler 95.0 (35.) 199.2 (36.) 273.0 (40.)
 Trefferlage 2.35 mm links, 1.68 mm tief
 Streuwert 4.17, horizontal: 5.01, vertikal: 3.11

Unterschrift des Schützen

Meyton Elektronik

Ergebnis: **377** (396.9)
 Serien: 95 93 93 96
 Zähler: 20 17 3 0 0 0 0 0 0 0
 Innenzehner: 19
 weiteste: 529 (18), 524 (24), 515 (25)
 beste Teiler 31.9 (2.) 34.7 (13.) 60.0 (5.)
 Trefferlage 0.07 mm rechts, 0.73 mm hoch
 Streuwert 2.01, horizontal: 2.21, vertikal: 1.79

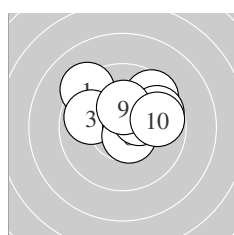
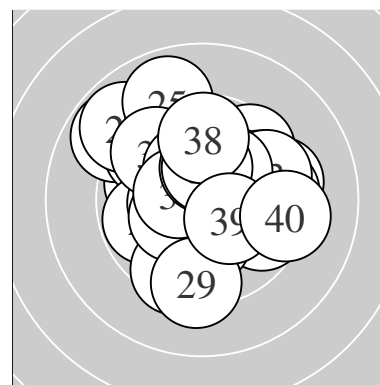

Serie 1:
 9.2 ↘ 10.8 * 9.9 ↖ 9.6 ↗ 10.7 *
 10.6 * 10.3 * 9.7 ↗ 10.3 * 9.8 →
 beste Teiler 31.9 (2.) 60.0 (5.) 89.4 (6.)
 Trefferlage 0.54 mm rechts, 1.00 mm hoch
 Streuwert 1.65, horizontal: 2.02, vertikal: 1.16

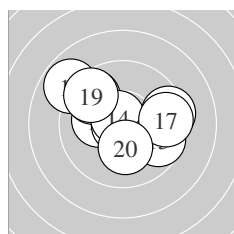

Serie 2:
 10.2 * 9.6 ↘ 10.8 * 10.7 * 9.7 →
 9.4 → 9.5 → 8.8 ↘ 9.5 ↘ 10.2 *
 beste Teiler 34.7 (13.) 67.0 (14.) 193.3 (20.)
 Trefferlage 0.14 mm links, 0.65 mm hoch
 Streuwert 2.28, horizontal: 2.81, vertikal: 1.59

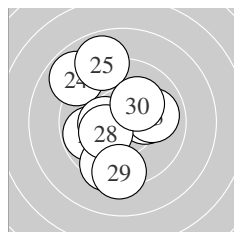

Serie 3:
 9.8 ← 10.2 * 10.0 → 8.9 ↘ 8.9 ↖
 9.5 ↓ 10.4 * 10.3 * 9.3 ↓ 10.2 *
 beste Teiler 146.6 (27.) 161.3 (28.) 189.7 (22.)
 Trefferlage 0.71 mm links, 0.14 mm hoch
 Streuwert 2.42, horizontal: 2.01, vertikal: 2.78

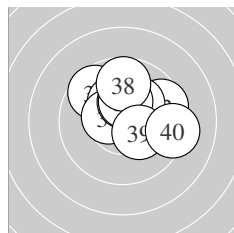

Serie 4:
 9.6 ↘ 10.3 * 9.6 → 10.5 * 10.2 *
 10.3 * 10.3 * 9.7 ↑ 10.3 * 9.3 →
 beste Teiler 121.1 (34.) 159.6 (36.) 162.9 (37.)
 Trefferlage 0.62 mm rechts, 1.14 mm hoch
 Streuwert 1.64, horizontal: 1.94, vertikal: 1.27

Unterschrift des Schützen

Meyton Elektronik

Ergebnis:	328	(343.4)
Serien:	88	77 87 76
Zähler:	8	11 8 9 3 0 1 0 0 0
Innenzehner:	3	
weiteste:	1602 (33), 1220 (37), 1121 (15)	
beste Teiler	85.0 (21.)	173.1 (16.) 179.7 (5.)
Trefferlage	1.49 mm rechts,	0.06 mm hoch
Streuwert	4.74, horizontal:	6.04, vertikal: 2.90

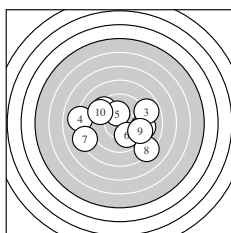
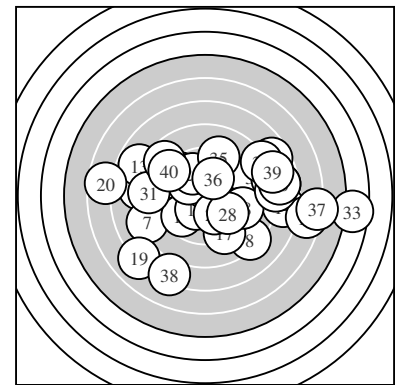

Serie 1:

9.2 →	9.5 ↘	8.8 ↗	8.1 ←	10.2 *
10.0 ↘	8.2 ←	8.3 ↘	9.4 →	9.3 ↘
beste Teiler	179.7 (5.)	248.6 (6.)	374.6 (2.)	
Trefferlage	0.10 mm links, 0.25 mm tief			
Streuwert	3.69, horizontal: 4.60, vertikal: 2.46			

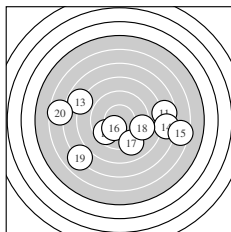

Serie 2:

7.7 →	9.6 ↙	7.8 ↘	7.5 →	6.5 →
10.3 *	9.1 ↘	9.2 →	7.0 ↙	6.6 ←
beste Teiler	173.1 (16.)	328.9 (12.)	427.5 (18.)	
Trefferlage	0.51 mm rechts, 1.30 mm tief			
Streuwert	5.65, horizontal: 7.45, vertikal: 2.87			

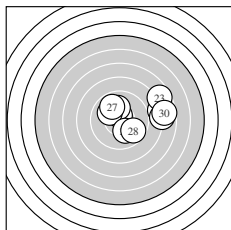

Serie 3:

10.6 *	8.0 →	7.6 ↗	10.1 ↑	10.1 ↘
10.1 ↘	9.9 ↘	9.7 ↘	7.9 →	7.7 →
beste Teiler	85.0 (21.)	217.4 (26.)	221.6 (25.)	
Trefferlage	3.02 mm rechts, 1.06 mm hoch			
Streuwert	3.16, horizontal: 4.07, vertikal: 1.84			

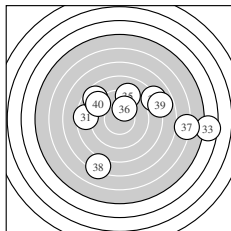

Serie 4:

8.5 ←	8.7 ↘	4.5 →	8.1 ↗	9.2 ↑
10.1 ↑	6.1 →	7.2 ↓	7.9 →	9.1 ↘
beste Teiler	208.4 (36.)	444.3 (35.)	474.4 (40.)	
Trefferlage	2.56 mm rechts, 0.75 mm hoch			
Streuwert	6.00, horizontal: 7.56, vertikal: 3.86			

Unterschrift des Schützen

Meyton Elektronik

Ergebnis:	376	(395.4)
Serien:	94 93 96 93	
Zähler:	18 20 2 0 0 0 0 0 0 0	
Innenzehner:	15	
weiteste:	659 (14), 583 (37), 478 (9)	
beste Teiler	41.6 (13.) 52.0 (35.) 62.5 (16.)	
Trefferlage	0.07 mm links, 0.26 mm hoch	
Streuwert	2.17, horizontal: 2.35, vertikal: 1.98	

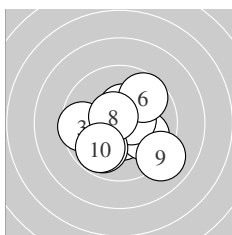
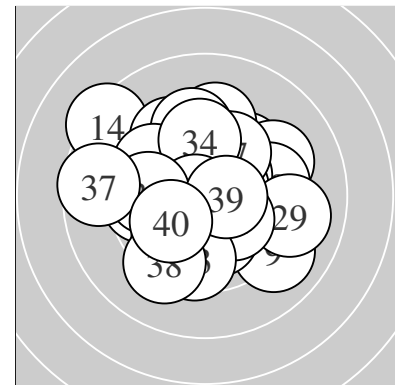

Serie 1:	10.5 *	10.4 *	9.6 ←	9.9 ↘	10.5 *
	9.7 ↗	9.9 ↙	10.6 *	9.0 ↘	9.8 ↙
beste Teiler	82.7 (8.) 111.5 (5.) 114.1 (1.)				
Trefferlage	0.25 mm rechts, 0.55 mm tief				
Streuwert	1.94, horizontal: 2.15, vertikal: 1.71				

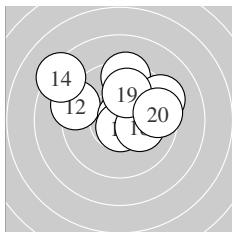

Serie 2:	10.6 *	9.3 ↖	10.8 *	8.3 ↖	9.4 ↑
	10.7 *	9.3 ↗	10.2 *	9.9 ↑	9.5 →
beste Teiler	41.6 (13.) 62.5 (16.) 100.1 (11.)				
Trefferlage	0.21 mm rechts, 1.32 mm hoch				
Streuwert	2.36, horizontal: 2.89, vertikal: 1.69				

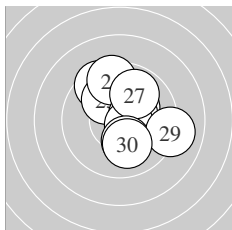

Serie 3:	9.5 ↖	10.2 *	10.1 ↖	9.5 ↑	10.4 *
	10.6 *	9.9 ↗	10.2 *	9.1 →	10.1 ↓
beste Teiler	97.0 (26.) 130.6 (25.) 179.4 (22.)				
Trefferlage	0.69 mm rechts, 0.70 mm hoch				
Streuwert	1.93, horizontal: 1.79, vertikal: 2.05				

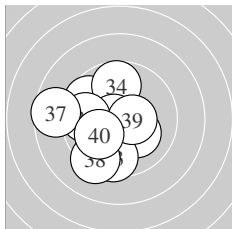

Serie 4:	10.2 *	9.6 ↖	9.6 ↓	9.7 ↑	10.7 *
	9.7 ←	8.6 ←	9.3 ↙	10.5 *	10.0 ↙
beste Teiler	52.0 (35.) 115.1 (39.) 198.8 (31.)				
Trefferlage	1.44 mm links, 0.42 mm tief				
Streuwert	2.13, horizontal: 2.18, vertikal: 2.09				

Unterschrift des Schützen

Ergebnis: **328** (344.4)
 Serien: 83 86 82 77
 Zähler: 5 13 11 9 1 0 1 0 0 0
 Innenzehner: 5
 weiteste: 1515 (35), 1106 (34), 991 (27)
 beste Teiler 8.0 (21.) 81.0 (18.) 157.0 (3.)
 Trefferlage 0.72 mm links, 1.85 mm hoch
 Streuwert 4.50, horizontal: 5.24, vertikal: 3.61

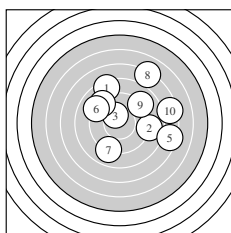
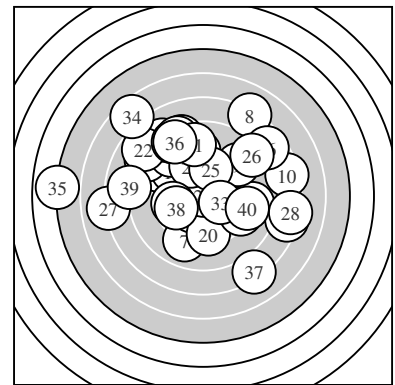

Serie 1:
 8.3 ↗ 8.9 → 10.3 * 9.1 ↘ 7.3 →
 9.1 ↖ 9.0 ↓ 7.1 ↗ 9.0 ↗ 7.4 →
 beste Teiler 157.0 (3.) 452.1 (4.) 474.2 (6.)
 Trefferlage 1.91 mm rechts, 1.94 mm hoch
 Streuwert 4.38, horizontal: 4.86, vertikal: 3.85

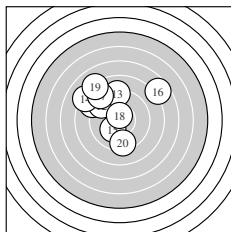

Serie 2:
 8.8 ↖ 9.3 ↖ 9.1 ↑ 8.2 ↖ 10.2 *
 7.6 ↗ 8.8 ↖ 10.6 * 8.1 ↖ 9.4 ↓
 beste Teiler 81.0 (18.) 194.4 (15.) 398.8 (20.)
 Trefferlage 1.57 mm links, 2.39 mm hoch
 Streuwert 3.37, horizontal: 3.61, vertikal: 3.11

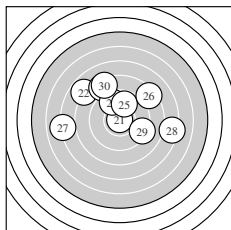

Serie 3:
 10.9 * 7.8 ↖ 8.4 ↖ 9.6 ↗ 9.8 ↑
 8.3 ↗ 7.0 ← 7.3 → 9.2 → 8.3 ↖
 beste Teiler 8.0 (21.) 290.5 (25.) 334.6 (24.)
 Trefferlage 0.41 mm links, 2.17 mm hoch
 Streuwert 4.49, horizontal: 5.54, vertikal: 3.11

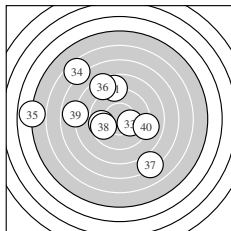

Serie 4:
 8.8 ↑ 9.7 ← 10.2 * 6.5 ↖ 4.9 ←
 8.4 ↖ 7.1 ↘ 9.7 ← 7.9 ← 9.0 →
 beste Teiler 193.3 (33.) 305.3 (38.) 323.5 (32.)
 Trefferlage 2.82 mm links, 0.90 mm hoch
 Streuwert 5.42, horizontal: 6.16, vertikal: 4.57

Unterschrift des Schützen

Meyton Elektronik

Ergebnis: **386** (404.9)
 Serien: 98 99 93 96 9
 Zähler: 26 15 0 0 0 0 0 0 0
 Innenzehner: 20
 weiteste: 420 (33), 415 (34), 392 (24)
 beste Teiler 38.0 (2.) 45.7 (32.) 53.7 (8.)
 Trefferlage 0.22 mm links, 0.03 mm tief
 Streuwert 1.66, horizontal: 1.76, vertikal: 1.55

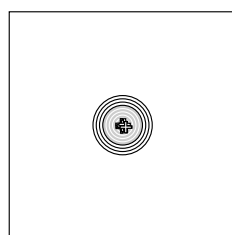
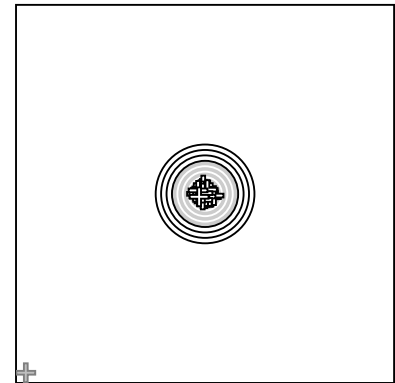

Serie 1:
 10.5 * 10.8 * 10.7 * 10.3 * 9.6 ↘
 10.2 * 10.5 * 10.7 * 10.3 * 9.8 ↘
 beste Teiler 38.0 (2.) 53.7 (8.) 63.8 (3.)
 Trefferlage 0.48 mm rechts, 0.69 mm tief
 Streuwert 1.15, horizontal: 1.36, vertikal: 0.91

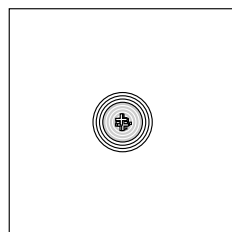

Serie 2:
 9.9 ↘ 10.2 * 10.2 * 10.4 * 10.2 *
 10.7 * 10.6 * 10.0 ↙ 10.1 ↓ 10.1 ↖
 beste Teiler 58.6 (16.) 77.3 (17.) 133.5 (14.)
 Trefferlage 0.00 mm , 0.38 mm tief
 Streuwert 1.37, horizontal: 1.05, vertikal: 1.64

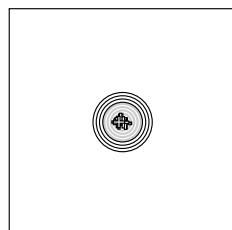

Serie 3:
 9.8 ↘ 10.0 ↘ 9.8 ↖ 9.4 ← 9.9 ↖
 10.2 * 9.8 ← 9.8 ↖ 10.7 * 9.8 ←
 beste Teiler 53.8 (29.) 191.3 (26.) 243.4 (22.)
 Trefferlage 1.06 mm links, 0.43 mm hoch
 Streuwert 1.82, horizontal: 2.20, vertikal: 1.35

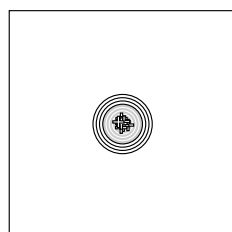

Serie 4:
 10.0 ↗ 10.8 * 9.3 → 9.3 ↑ 10.2 *
 10.4 * 10.1 ↗ 9.8 ↓ 10.5 * 9.5 ↖
 beste Teiler 45.7 (32.) 105.1 (39.) 128.0 (36.)
 Trefferlage 0.06 mm links, 0.63 mm hoch
 Streuwert 1.96, horizontal: 1.98, vertikal: 1.94

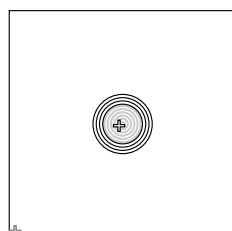

Serie 5:
 9.7 ← 0.0+
AST
 beste Teiler
 Trefferlage 2.74 mm links, 1.33 mm tief
 Streuwert 0.00, horizontal: 0.00, vertikal: 0.00

AST – Treffer wurde nach Ende der Schießzeit abgegeben

Meyton Elektronik

LG Liga Österreich – Wertung –

offene Klasse

StartNr: 33

StandNr: 133

18. November 2017 14:18

Tschaudi, Angelina #70804100

Vorarlberg1 Jugend 2 / Vorarlberg1 Jugend 2

Unterschrift des Schützen

Meyton Elektronik

Ergebnis: **368** (387.7)
 Serien: 93 93 93 89 9
 Zähler: 15 20 5 1 0 0 0 0 0 0
 Innenzehner: 11
 weiteste: 855 (13), 697 (39), 672 (8)
 beste Teiler 36.2 (31.) 65.0 (38.) 94.0 (1.)
 Trefferlage 0.00 mm , 1.13 mm hoch
 Streuwert 2.49, horizontal: 3.17, vertikal: 1.53

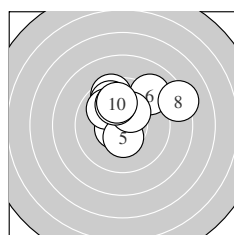
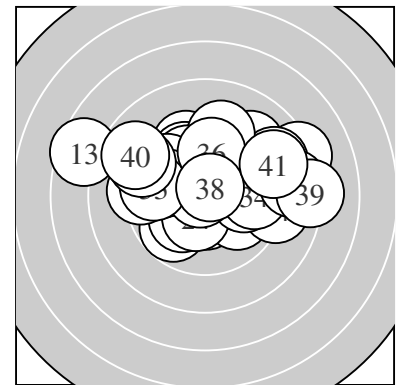

Serie 1:
 10.6 * 9.5 ↖ 9.8 ↖ 9.9 ↘ 10.4 *
 9.1 ↗ 10.3 * 8.3 → 10.0 ↖ 9.9 ↖
 beste Teiler 94.0 (1.) 132.2 (5.) 169.0 (7.)
 Trefferlage 0.34 mm rechts, 1.84 mm hoch
 Streuwert 2.07, horizontal: 2.47, vertikal: 1.56

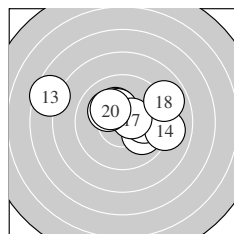

Serie 2:
 9.9 ↘ 10.0 → 7.5 ↖ 9.0 → 10.2 *
 10.3 * 10.5 * 8.9 ↗ 10.1 ↖ 10.2 *
 beste Teiler 108.0 (17.) 157.4 (16.) 177.9 (15.)
 Trefferlage 0.23 mm rechts, 0.90 mm hoch
 Streuwert 2.79, horizontal: 3.70, vertikal: 1.36

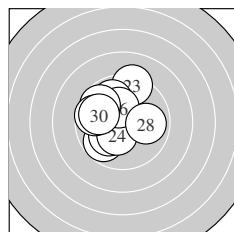

Serie 3:
 9.8 ↗ 10.1 ↗ 9.3 ↑ 10.3 * 9.9 ↖
 10.3 * 9.7 ↖ 9.9 → 9.7 ← 9.9 ←
 beste Teiler 153.6 (24.) 165.1 (26.) 212.1 (22.)
 Trefferlage 1.03 mm links, 0.63 mm hoch
 Streuwert 1.87, horizontal: 1.77, vertikal: 1.96

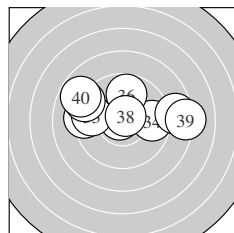

Serie 4:
 10.8 * 9.2 ← 9.6 ← 9.6 → 9.1 ↖
 9.8 ↑ 8.6 → 10.7 * 8.2 → 8.8 ↖
 beste Teiler 36.2 (31.) 65.0 (38.) 297.1 (36.)
 Trefferlage 0.00 mm , 1.05 mm hoch
 Streuwert 3.11, horizontal: 4.25, vertikal: 1.11

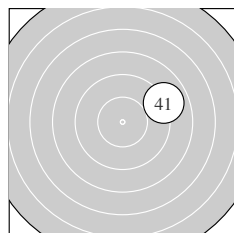

Serie 5:
 9.0 →
 beste Teiler
 Trefferlage 4.54 mm rechts, 2.11 mm hoch
 Streuwert 0.00, horizontal: 0.00, vertikal: 0.00

Unterschrift des Schützen

Meyton Elektronik

Ergebnis: **366** (385.1)
 Serien: 91 95 93 87 10
 Zähler: 13 22 6 0 0 0 0 0 0
 Innenzehner: 10
 weiteste: 592 (38), 553 (40), 550 (39)
 beste Teiler 19.2 (17.) 101.8 (5.) 125.4 (14.)
 Trefferlage 0.45 mm rechts, 0.14 mm tief
 Streuwert 2.55, horizontal: 2.83, vertikal: 2.24

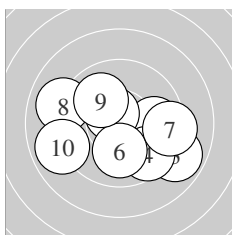
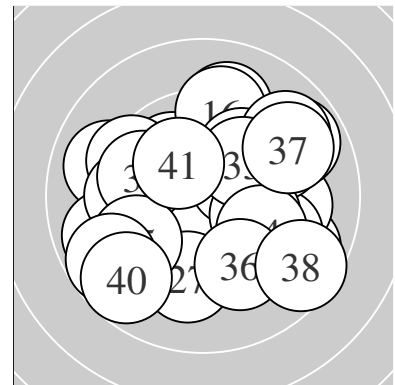

Serie 1:
 9.9 ↘ 9.8 → 8.9 ↘ 9.6 ↘ 10.5 *
 10.1 ↓ 9.3 → 9.0 ← 10.0 ↖ 8.9 ←
 beste Teiler 101.8 (5.) 225.0 (6.) 243.1 (9.)
 Trefferlage 0.41 mm rechts, 0.74 mm tief
 Streuwert 2.64, horizontal: 3.33, vertikal: 1.71

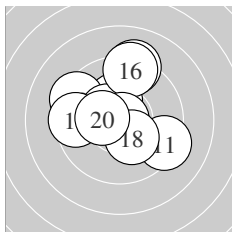

Serie 2:
 9.3 ↘ 10.3 * 9.4 ↖ 10.5 * 9.1 ↑
 9.3 ↑ 10.9 * 10.3 * 9.5 ← 10.4 *
 beste Teiler 19.2 (17.) 125.4 (14.) 144.1 (20.)
 Trefferlage 0.30 mm links, 0.95 mm hoch
 Streuwert 2.15, horizontal: 2.22, vertikal: 2.08

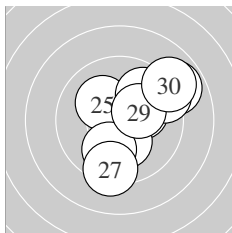

Serie 3:
 8.9 ↗ 10.2 * 9.3 ↗ 10.2 * 10.2 *
 9.9 ↓ 9.3 ↓ 9.8 ↗ 10.3 * 9.0 ↗
 beste Teiler 174.8 (29.) 179.2 (24.) 186.3 (22.)
 Trefferlage 1.49 mm rechts, 0.43 mm hoch
 Streuwert 2.25, horizontal: 2.13, vertikal: 2.35

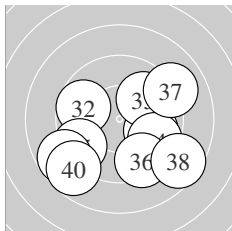

Serie 4:
 9.9 ↘ 9.7 ← 9.9 ↗ 9.6 ↘ 9.4 ↖
 9.4 ↘ 9.0 ↗ 8.6 ↘ 8.8 ↖ 8.7 ↖
 beste Teiler 256.2 (33.) 273.6 (31.) 313.3 (32.)
 Trefferlage 0.36 mm rechts, 1.38 mm tief
 Streuwert 3.02, horizontal: 3.60, vertikal: 2.32

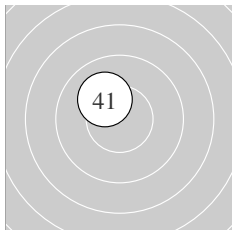

Serie 5:
 10.1 ↖
 beste Teiler
 Trefferlage 1.21 mm links, 1.61 mm hoch
 Streuwert 0.00, horizontal: 0.00, vertikal: 0.00

Unterschrift des Schützen

Meyton Elektronik

Ergebnis:	374	(392.4)							
Serien:	94	90	93	97	9				
Zähler:	19	17	5	0	0	0	0	0	0
Innenzehner:	12								
weiteste:	725 (22), 721 (21), 616 (20)								
beste Teiler	20.1 (31.)	34.0 (39.)	58.2 (14.)						
Trefferlage	0.83 mm rechts,	0.52 mm hoch							
Streuwert	2.27, horizontal: 2.87, vertikal: 1.44								

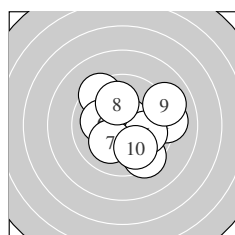
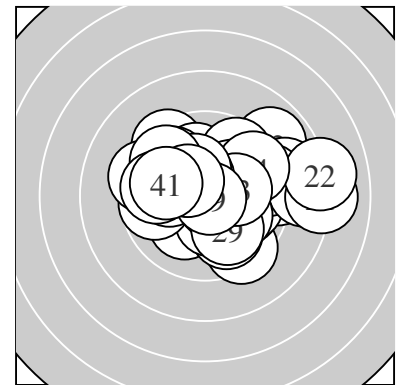

Serie 1:

9.1 →	9.4 ↘	10.7 *	9.4 ↖	9.9 →
10.1 ←	10.1 ↙	10.0 ↑	9.0 ↗	9.9 ↘
beste Teiler	72.1 (3.)	210.8 (7.)	216.7 (6.)	
Trefferlage	0.90 mm rechts,	0.09 mm hoch		
Streuwert	2.29, horizontal: 2.48, vertikal: 2.08			

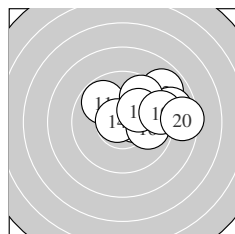

Serie 2:

9.8 ↖	8.9 ↗	10.4 *	10.7 *	8.9 →
9.9 →	9.7 ↗	10.1 ↗	9.3 →	8.5 →
beste Teiler	58.2 (14.)	128.7 (13.)	205.8 (18.)	
Trefferlage	2.39 mm rechts,	1.15 mm hoch		
Streuwert	1.95, horizontal: 2.49, vertikal: 1.20			

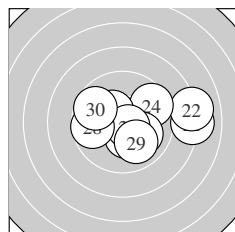

Serie 3:

8.1 →	8.1 →	10.3 *	9.6 ↗	10.4 *
10.0 ↘	10.7 *	9.7 ←	10.0 ↘	9.7 ↖
beste Teiler	73.2 (27.)	149.2 (25.)	154.4 (23.)	
Trefferlage	1.45 mm rechts,	0.01 mm tief		
Streuwert	2.70, horizontal: 3.58, vertikal: 1.34			

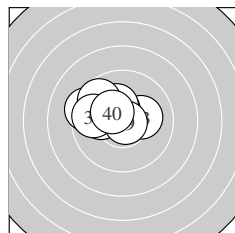

Serie 4:

10.9 *	10.1 ←	10.2 *	9.4 ↖	10.5 *
10.3 *	9.7 ↖	9.7 ←	10.8 *	10.4 *
beste Teiler	20.1 (31.)	34.0 (39.)	121.8 (35.)	
Trefferlage	1.11 mm links,	0.82 mm hoch		
Streuwert	1.32, horizontal: 1.73, vertikal: 0.71			

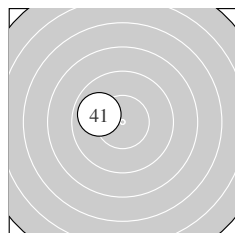

Serie 5:

9.9 ↖		
beste Teiler	2.41 mm links,	0.79 mm hoch
Trefferlage	0.00, horizontal: 0.00, vertikal: 0.00	

Unterschrift des Schützen

Meyton Elektronik

Ergebnis:	358	(375.4)
Serien:	89 90 92 87 8	
Zähler:	10 20 10 0 1 0 0 0 0 0	
Innenzehner:	5	
weiteste:	1023 (38), 739 (35), 662 (21)	
beste Teiler	99.0 (7.) 103.7 (17.) 111.6 (40.)	
Trefferlage	0.45 mm links, 0.46 mm hoch	
Streuwert	3.15, horizontal: 3.22, vertikal: 3.09	

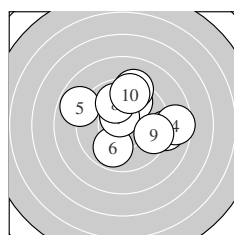
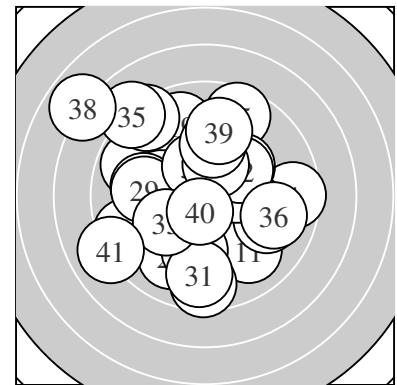

Serie 1:	9.0 →	9.8 ↗	9.3 ↗	8.6 →	8.8 ↖
	9.9 ↘	10.6 *	9.9 ↖	9.5 →	9.5 ↗
beste Teiler	99.0 (7.)	261.2 (8.)	269.5 (6.)		
Trefferlage	1.04 mm rechts, 1.17 mm hoch				
Streuwert	2.69, horizontal: 3.14, vertikal: 2.14				

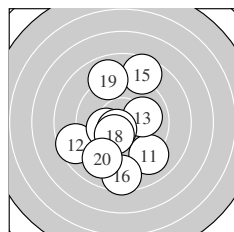

Serie 2:	9.1 ↘	8.6 ↖	10.0 →	10.2 *	8.6 ↗
	8.6 ↓	10.5 *	10.3 *	8.9 ↖	9.1 ↘
beste Teiler	103.7 (17.)	169.4 (18.)	197.6 (14.)		
Trefferlage	0.54 mm links, 0.82 mm tief				
Streuwert	3.13, horizontal: 2.51, vertikal: 3.66				

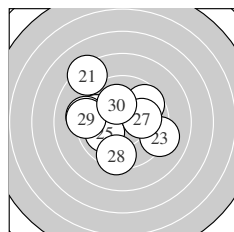

Serie 3:	8.3 ↖	9.7 ↖	9.2 ↘	9.7 ↗	10.0 ↖
	9.3 ←	10.1 →	9.4 ↓	9.3 ←	10.1 ↖
beste Teiler	211.8 (30.)	220.2 (27.)	233.8 (25.)		
Trefferlage	0.98 mm links, 0.51 mm hoch				
Streuwert	2.74, horizontal: 3.03, vertikal: 2.42				

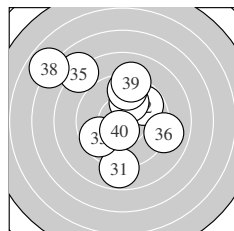

Serie 4:	8.8 ↓	9.8 ↗	9.7 ↖	10.1 ↗	8.0 ↖
	9.0 →	9.5 ↗	6.9 ↖	9.2 ↗	10.5 *
beste Teiler	111.6 (40.)	223.8 (34.)	295.0 (32.)		
Trefferlage	0.74 mm links, 1.38 mm hoch				
Streuwert	3.68, horizontal: 3.71, vertikal: 3.65				

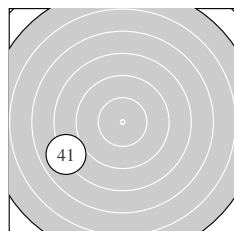

Serie 5:	8.0 ↖				
beste Teiler	6.39 mm links, 3.66 mm tief				
Trefferlage	0.00, horizontal: 0.00, vertikal: 0.00				

Unterschrift des Schützen

Meyton Elektronik

Ergebnis:	377	(395.4)
Serien:	95 95 95 92 9	
Zähler:	20 18 3 0 0 0 0 0 0	
Innenzehner:	18	
weiteste:	646 (32), 576 (5), 557 (11)	
beste Teiler	31.4 (7.) 62.2 (24.) 119.0 (18.)	
Trefferlage	0.55 mm links, 0.30 mm tief	
Streuwert	2.15, horizontal: 2.55, vertikal: 1.66	

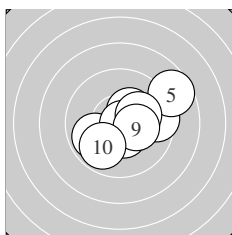
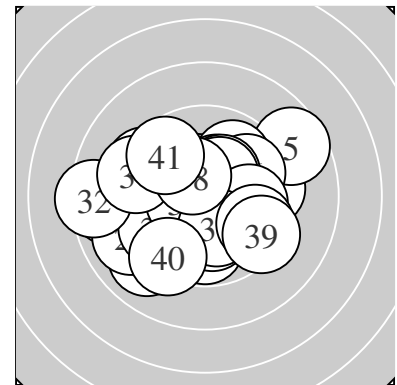

Serie 1:

10.5 *	9.5 →	10.2 *	9.9 ↙	8.6 ↗
10.3 *	10.8 *	10.2 *	10.3 *	9.9 ↙
beste Teiler	31.4 (7.)	119.6 (1.)	152.7 (6.)	
Trefferlage	0.83 mm rechts, 0.10 mm tief			
Streuwert	1.94, horizontal: 2.31, vertikal: 1.49			

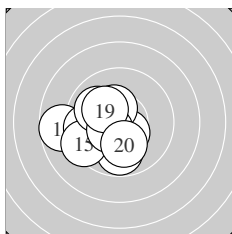

Serie 2:

8.7 ←	10.5 *	9.7 ←	9.8 ↓	9.4 ↙
10.0 ↘	10.4 *	10.5 *	10.2 *	10.1 ↓
beste Teiler	119.0 (18.)	122.5 (12.)	145.0 (17.)	
Trefferlage	1.60 mm links, 0.60 mm tief			
Streuwert	1.75, horizontal: 1.98, vertikal: 1.50			

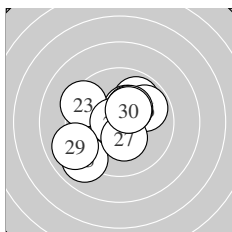

Serie 3:

9.9 ↗	10.4 *	9.4 ↘	10.7 *	9.0 ↙
9.9 ↗	10.3 *	10.3 *	9.0 ↙	10.4 *
beste Teiler	62.2 (24.)	145.2 (30.)	147.1 (22.)	
Trefferlage	0.48 mm links, 0.16 mm hoch			
Streuwert	2.17, horizontal: 2.37, vertikal: 1.95			

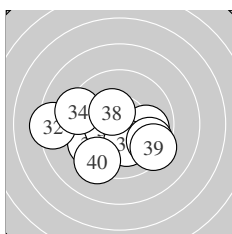

Serie 4:

9.6 ↙	8.4 ←	10.5 *	9.3 ↘	9.9 →
10.2 *	9.6 ↘	10.4 *	9.4 ↘	9.3 ↙
beste Teiler	122.9 (33.)	137.9 (38.)	195.8 (36.)	
Trefferlage	0.79 mm links, 0.95 mm tief			
Streuwert	2.50, horizontal: 3.19, vertikal: 1.52			

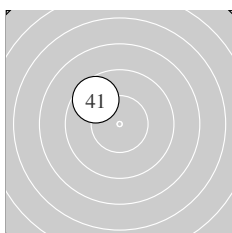

Serie 5:

9.6 ↘				
beste Teiler	2.31 mm links, 2.35 mm hoch			
Trefferlage	0.00, horizontal: 0.00, vertikal: 0.00			
Streuwert				

Unterschrift des Schützen

Meyton Elektronik

Ergebnis:	354	(371.5)
Serien:	92 89 87 86 10	
Zähler:	13 15 8 5 0 0 0 0 0	
Innenzehner:	8	
weiteste:	881 (17), 798 (30), 793 (32)	
beste Teiler	81.0 (4.) 110.6 (9.) 135.7 (24.)	
Trefferlage	0.37 mm rechts, 0.25 mm tief	
Streuwert	3.32, horizontal: 4.06, vertikal: 2.35	

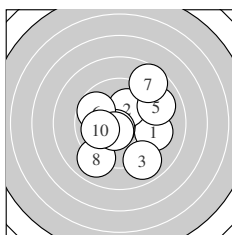
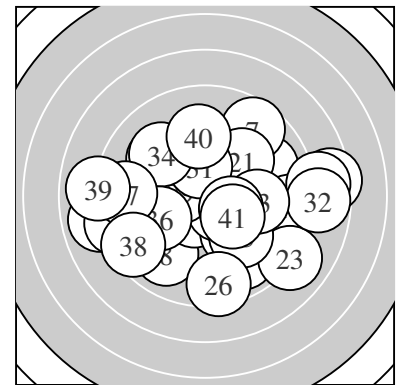

Serie 1:

9.3 →	10.2 *	8.9 ↘	10.6 *	9.1 →
9.7 ↖	8.7 ↗	9.0 ↙	10.5 *	10.0 ←

beste Teiler 81.0 (4.) 110.6 (9.) 198.1 (2.)
 Trefferlage 0.63 mm rechts, 0.18 mm tief
 Streuwert 2.77, horizontal: 2.78, vertikal: 2.76

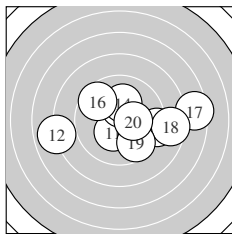

Serie 2:

10.3 *	7.9 ←	10.4 *	10.1 ↑	9.2 →
9.6 ↖	7.4 →	8.6 →	9.7 ↘	10.3 *

beste Teiler 140.5 (13.) 155.7 (11.) 160.3 (20.)
 Trefferlage 1.23 mm rechts, 0.07 mm tief
 Streuwert 3.40, horizontal: 4.51, vertikal: 1.66

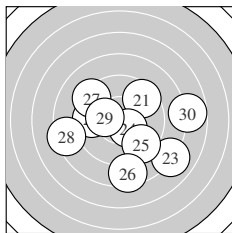

Serie 3:

9.5 ↗	9.6 ←	8.0 ↘	10.4 *	9.5 ↘
8.5 ↓	9.3 ↖	8.4 ←	10.3 *	7.8 →

beste Teiler 135.7 (24.) 175.9 (29.) 326.7 (22.)
 Trefferlage 0.64 mm rechts, 0.97 mm tief
 Streuwert 3.70, horizontal: 4.38, vertikal: 2.86

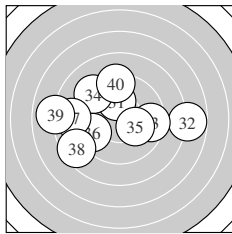

Serie 4:

10.1 ↑	7.8 →	9.5 →	9.3 ↖	10.1 ↘
9.5 ←	8.7 ←	8.5 ←	7.9 ←	9.3 ↑

beste Teiler 202.1 (35.) 210.9 (31.) 356.8 (36.)
 Trefferlage 1.18 mm links, 0.32 mm hoch
 Streuwert 3.68, horizontal: 4.70, vertikal: 2.23

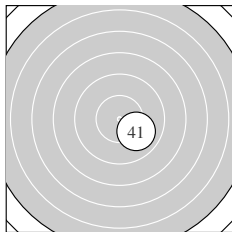

Serie 5:

10.0 ↘				
--------	--	--	--	--

beste Teiler
 Trefferlage 1.93 mm rechts, 1.44 mm tief
 Streuwert 0.00, horizontal: 0.00, vertikal: 0.00

Unterschrift des Schützen

Meyton Elektronik

Ergebnis:	350	(369.5)
Serien:	86	88 86 90 8
Zähler:	8	17 13 3 0 0 0 0 0 0
Innenzehner:	6	
weiteste:	921	(20), 916 (5), 808 (3)
beste Teiler	30.6	(13.) 89.1 (22.) 93.1 (19.)
Trefferlage	0.51 mm	links, 0.89 mm hoch
Streuwert	3.37,	horizontal: 4.02, vertikal: 2.57

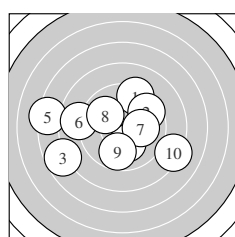
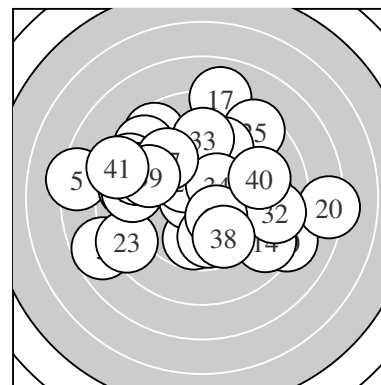

Serie 1:

9.3 ↗	9.6 ↗	7.7 ↖	10.1 ↓	7.3 ←
8.8 ←	10.1 →	9.9 ↘	9.8 ↓	8.2 ↘
beste Teiler	202.4 (4.)	220.2 (7.)	255.5 (8.)	
Trefferlage	1.09 mm links, 0.25 mm tief			
Streuwert	3.84, horizontal: 4.81, vertikal: 2.51			

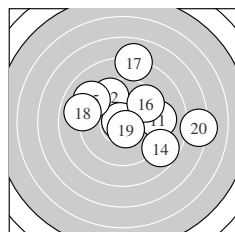

Serie 2:

9.2 →	9.6 ↖	10.8 *	8.7 ↘	9.1 ↘
9.5 ↗	8.0 ↑	9.0 ←	10.6 *	7.3 →
beste Teiler	30.6 (13.)	93.1 (19.)	341.2 (12.)	
Trefferlage	1.21 mm rechts, 1.22 mm hoch			
Streuwert	3.57, horizontal: 4.19, vertikal: 2.82			

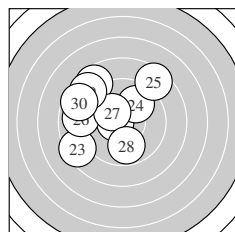

Serie 3:

8.6 ↖	10.6 *	8.4 ↖	9.9 ↗	8.5 ↗
8.9 ←	10.3 *	9.8 ↓	8.7 ↘	8.6 ↖
beste Teiler	89.1 (22.)	173.2 (27.)	268.2 (24.)	
Trefferlage	1.97 mm links, 1.35 mm hoch			
Streuwert	3.01, horizontal: 3.20, vertikal: 2.81			

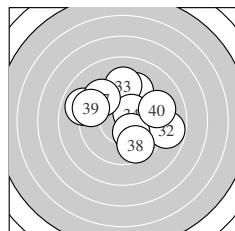

Serie 4:

9.4 ↗	8.8 →	9.2 ↑	10.4 *	8.9 ↖
10.3 *	9.4 ↖	9.7 ↓	9.3 ↖	9.2 →
beste Teiler	145.0 (34.)	169.0 (36.)	321.3 (38.)	
Trefferlage	0.35 mm rechts, 1.12 mm hoch			
Streuwert	2.79, horizontal: 3.23, vertikal: 2.26			

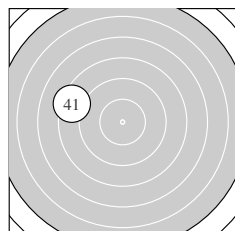

Serie 5:

8.3 ↖				
beste Teiler				
Trefferlage	6.13 mm links, 2.21 mm hoch			
Streuwert	0.00, horizontal: 0.00, vertikal: 0.00			

Unterschrift des Schützen

Meyton Elektronik

Ergebnis: **389** (408.2)
 Serien: 97 98 97 97
 Zähler: 29 11 0 0 0 0 0 0 0 0
 Innenzehner: 23
 weiteste: 398 (3), 384 (24), 356 (37)
 beste Teiler 32.2 (4.) 46.8 (30.) 63.7 (22.)
 Trefferlage 0.60 mm links, 0.29 mm hoch
 Streuwert 1.43, horizontal: 1.50, vertikal: 1.35

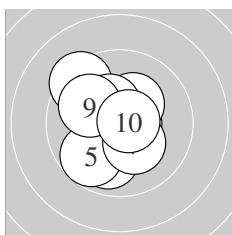
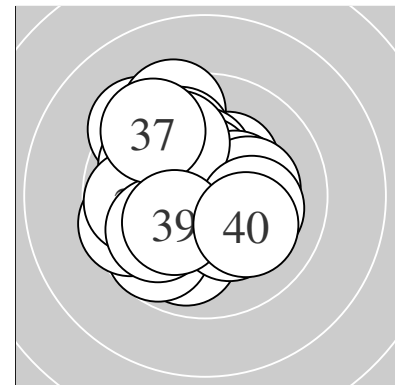

Serie 1:
 10.6 * 9.9 ↘ 9.4 ↖ 10.8 * 9.7 ↙
 10.3 * 10.3 * 10.4 * 10.0 ↖ 10.7 *
 beste Teiler 32.2 (4.) 64.5 (10.) 77.0 (1.)
 Trefferlage 0.48 mm links, 0.04 mm hoch
 Streuwert 1.57, horizontal: 1.42, vertikal: 1.71

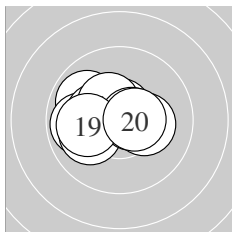

Serie 2:
 9.9 ↖ 9.9 ← 10.3 * 10.7 * 10.4 *
 10.2 * 10.0 ← 10.6 * 10.0 ← 10.5 *
 beste Teiler 73.1 (14.) 84.4 (18.) 107.0 (20.)
 Trefferlage 0.81 mm links, 0.18 mm hoch
 Streuwert 1.26, horizontal: 1.63, vertikal: 0.71

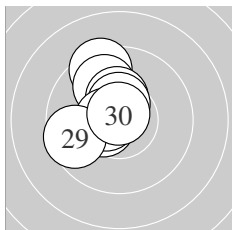

Serie 3:
 10.5 * 10.7 * 10.5 * 9.4 ↗ 9.9 ↗
 10.3 * 10.5 * 10.6 * 9.6 ← 10.8 *
 beste Teiler 46.8 (30.) 63.7 (22.) 96.0 (28.)
 Trefferlage 0.96 mm links, 0.78 mm hoch
 Streuwert 1.20, horizontal: 0.92, vertikal: 1.43

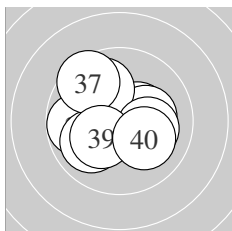

Serie 4:
 10.5 * 9.8 ← 10.4 * 10.2 * 9.9 ↗
 10.0 ↙ 9.5 ↘ 10.1 → 10.3 * 10.1 ↘
 beste Teiler 123.5 (31.) 139.3 (33.) 173.6 (39.)
 Trefferlage 0.16 mm links, 0.18 mm hoch
 Streuwert 1.71, horizontal: 1.94, vertikal: 1.43

Unterschrift des Schützen

Ergebnis: **382** (400.0)
 Serien: 94 97 95 96
 Zähler: 26 11 2 1 0 0 0 0 0 0
 Innenzehner: 21
 weiteste: 810 (22), 535 (5), 520 (37)
 beste Teiler 33.0 (17.) 43.0 (1.) 44.2 (24.)
 Trefferlage 0.20 mm links, 0.16 mm tief
 Streuwert 2.04, horizontal: 2.40, vertikal: 1.60

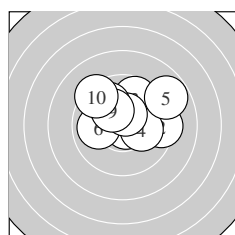
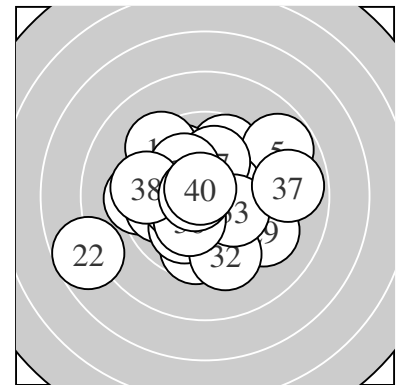

Serie 1:
 10.8 * 9.3 → 9.7 ↑ 10.1 → 8.8 ↗
 10.0 ← 10.5 * 9.9 ↘ 10.2 * 9.3 ↖
 beste Teiler 43.0 (1.) 115.2 (7.) 185.5 (9.)
 Trefferlage 0.47 mm rechts, 1.25 mm hoch
 Streuwert 2.04, horizontal: 2.52, vertikal: 1.43

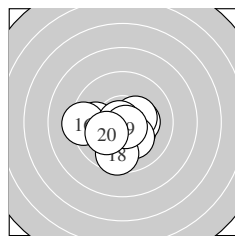

Serie 2:
 10.3 * 10.3 * 9.8 ← 10.4 * 10.2 *
 9.3 ← 10.8 * 9.6 ↓ 10.7 * 10.2 *
 beste Teiler 33.0 (17.) 59.3 (19.) 141.6 (14.)
 Trefferlage 0.38 mm links, 0.73 mm tief
 Streuwert 1.56, horizontal: 1.92, vertikal: 1.08

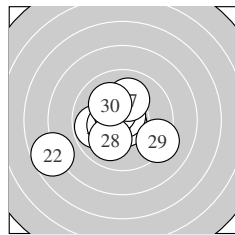

Serie 3:
 9.8 ← 7.7 ← 10.7 * 10.8 * 10.3 *
 10.5 * 10.1 ↑ 10.0 ↙ 9.3 ↘ 10.1 ↖
 beste Teiler 44.2 (24.) 59.1 (23.) 115.2 (26.)
 Trefferlage 1.02 mm links, 0.43 mm tief
 Streuwert 2.34, horizontal: 2.79, vertikal: 1.77

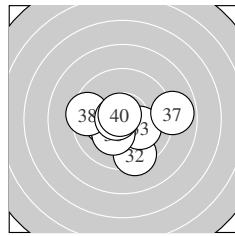

Serie 4:
 10.3 * 9.4 ↓ 10.2 * 10.3 * 10.3 *
 10.2 * 8.9 → 9.5 ← 10.7 * 10.7 *
 beste Teiler 54.0 (40.) 65.1 (39.) 166.2 (35.)
 Trefferlage 0.10 mm rechts, 0.74 mm tief
 Streuwert 1.92, horizontal: 2.38, vertikal: 1.31

Unterschrift des Schützen

Meyton Elektronik

Ergebnis:	389	(408.9)
Serien:	96 99 96 98	
Zähler:	29 11 0 0 0 0 0 0 0 0	
Innenzehner:	25	
weiteste:	492 (7), 350 (2), 342 (18)	
beste Teiler	47.2 (38.) 48.1 (6.) 55.4 (36.)	
Trefferlage	0.07 mm links, 0.28 mm hoch	
Streuwert	1.48, horizontal: 1.48, vertikal: 1.48	

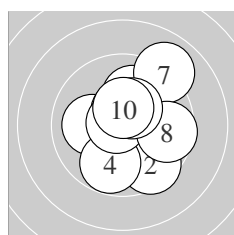
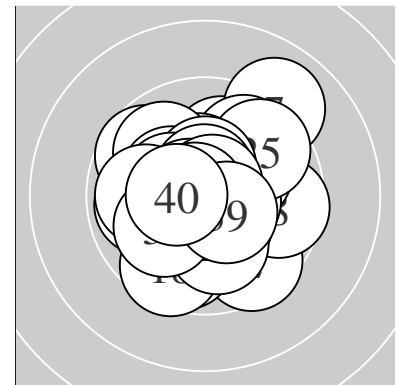

Serie 1:	10.1 ←	9.6 ↘	10.0 ↑	9.8 ↓	10.5 *
	10.8 *	9.0 ↗	9.6 →	10.4 *	10.4 *
beste Teiler	48.1 (6.)	101.4 (5.)	127.0 (10.)		
Trefferlage	0.61 mm rechts, 0.36 mm hoch				
Streuwert	1.91, horizontal: 1.75, vertikal: 2.07				

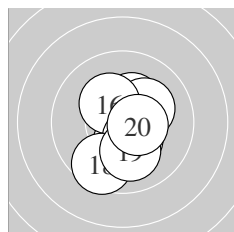

Serie 2:	10.3 *	10.5 *	10.3 *	10.2 *	10.4 *
	10.3 *	10.4 *	9.6 ↓	10.1 ↓	10.5 *
beste Teiler	112.9 (20.)	125.2 (12.)	142.6 (17.)		
Trefferlage	0.40 mm rechts, 0.22 mm tief				
Streuwert	1.34, horizontal: 0.98, vertikal: 1.63				

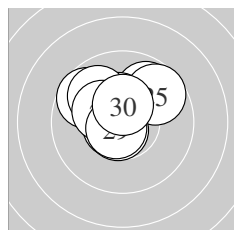

Serie 3:	9.7 ↖	9.8 ↗	10.4 *	9.9 ↖	9.7 ↗
	10.6 *	10.7 *	10.3 *	10.7 *	10.4 *
beste Teiler	65.0 (29.)	68.0 (27.)	76.4 (26.)		
Trefferlage	0.36 mm links, 1.00 mm hoch				
Streuwert	1.32, horizontal: 1.52, vertikal: 1.09				

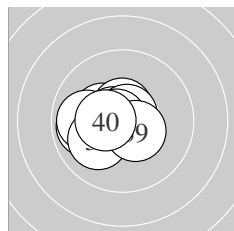

Serie 4:	9.9 ←	10.3 *	9.9 ←	10.6 *	10.7 *
	10.7 *	10.1 ↙	10.8 *	10.5 *	10.4 *
beste Teiler	47.2 (38.)	55.4 (36.)	74.4 (35.)		
Trefferlage	0.97 mm links, 0.00 mm				
Streuwert	0.97, horizontal: 1.21, vertikal: 0.66				

Unterschrift des Schützen

Meyton Elektronik

Ergebnis:	374	(390.8)
Serien:	94 95 92 93	
Zähler:	20 15 4 1 0 0 0 0 0 0	
Innenzehner:	14	
weiteste:	965 (28), 606 (40), 584 (25)	
beste Teiler	106.0 (18.) 107.0 (27.) 113.8 (35.)	
Trefferlage	1.18 mm links, 0.61 mm hoch	
Streuwert	2.26, horizontal: 2.55, vertikal: 1.93	

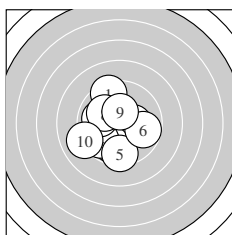
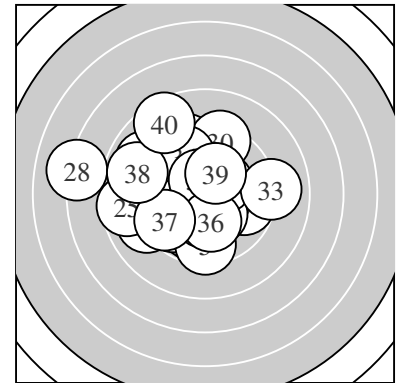

Serie 1:	9.4 ↗	10.3 *	9.8 ↘	9.7 ↙	9.5 ↓
	9.8 ↘	10.0 ←	10.1 ↖	10.4 *	9.0 ←
beste Teiler	141.1 (9.) 169.0 (2.) 222.4 (8.)				
Trefferlage	0.85 mm links, 0.44 mm tief				
Streuwert	2.18, horizontal: 2.11, vertikal: 2.25				

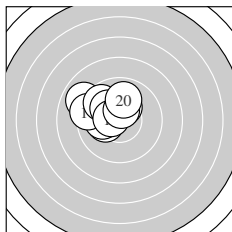

Serie 2:	10.2 *	10.1 ←	8.9 ↖	9.3 ↖	9.7 ↖
	10.3 *	10.1 ↖	10.5 *	10.5 *	9.9 ↑
beste Teiler	106.0 (18.) 124.7 (19.) 167.6 (16.)				
Trefferlage	1.56 mm links, 1.20 mm hoch				
Streuwert	1.42, horizontal: 1.71, vertikal: 1.04				

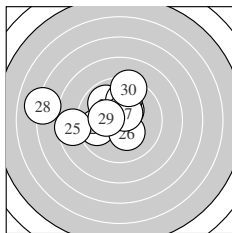

Serie 3:	9.9 ↖	10.4 *	9.8 ←	10.0 ↑	8.6 ←
	10.3 *	10.5 *	7.1 ←	10.3 *	9.3 ↑
beste Teiler	107.0 (27.) 142.8 (22.) 166.0 (29.)				
Trefferlage	1.75 mm links, 0.92 mm hoch				
Streuwert	2.74, horizontal: 3.49, vertikal: 1.70				

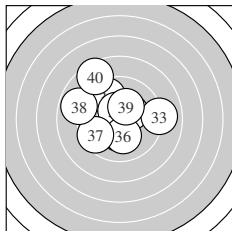

Serie 4:	10.3 *	10.3 *	9.0 →	9.7 ↖	10.5 *
	10.1 ↓	9.5 ↙	8.9 ↖	10.3 *	8.5 ↖
beste Teiler	113.8 (35.) 153.1 (31.) 170.8 (39.)				
Trefferlage	0.56 mm links, 0.76 mm hoch				
Streuwert	2.54, horizontal: 2.77, vertikal: 2.29				

Unterschrift des Schützen

Meyton Elektronik

Ergebnis: **383** (399.4)
 Serien: 93 98 98 94
 Zähler: 25 13 2 0 0 0 0 0 0 0
 Innenzehner: 20
 weiteste: 597 (3), 518 (36), 484 (4)
 beste Teiler 55.3 (12.) 73.7 (24.) 80.0 (2.)
 Trefferlage 0.03 mm links, 0.24 mm tief
 Streuwert 1.99, horizontal: 2.02, vertikal: 1.95

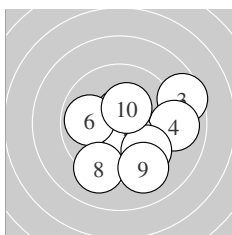
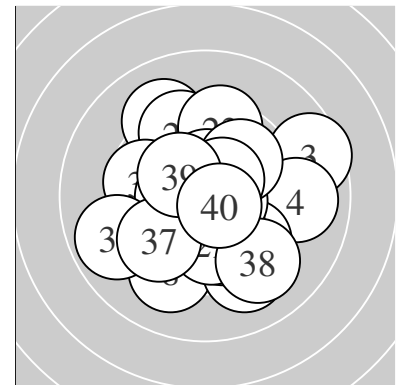

Serie 1:
 10.4 * 10.6 * 8.6 ↗ 9.0 → 10.4 *
 9.9 ← 9.6 ↘ 9.2 ↓ 9.2 ↓ 10.4 *
 beste Teiler 80.0 (2.) 135.3 (5.) 141.0 (1.)
 Trefferlage 1.09 mm rechts, 0.81 mm tief
 Streuwert 2.41, horizontal: 2.68, vertikal: 2.11

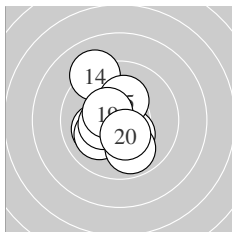

Serie 2:
 10.1 ↙ 10.7 * 10.3 * 9.1 ↖ 10.2 *
 10.1 ↙ 10.4 * 9.9 ↓ 10.5 * 10.4 *
 beste Teiler 55.3 (12.) 125.1 (19.) 138.7 (20.)
 Trefferlage 0.59 mm links, 0.05 mm tief
 Streuwert 1.59, horizontal: 1.25, vertikal: 1.87

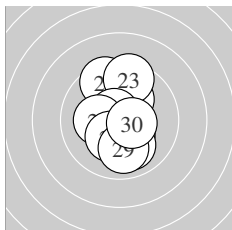

Serie 3:
 9.5 ↖ 10.1 ↗ 9.5 ↑ 10.7 * 10.3 *
 10.2 * 10.0 ↓ 10.3 * 10.0 ↓ 10.5 *
 beste Teiler 73.7 (24.) 111.0 (30.) 156.4 (25.)
 Trefferlage 0.04 mm rechts, 0.17 mm hoch
 Streuwert 1.72, horizontal: 1.07, vertikal: 2.18

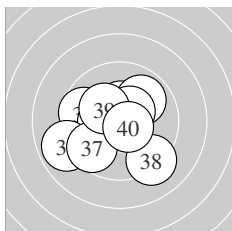

Serie 4:
 9.6 ↖ 10.4 * 9.9 ↗ 10.5 * 10.4 *
 8.9 ← 9.6 ↙ 9.2 ↘ 10.2 * 10.6 *
 beste Teiler 92.0 (40.) 125.2 (34.) 131.3 (32.)
 Trefferlage 0.67 mm links, 0.26 mm tief
 Streuwert 2.11, horizontal: 2.37, vertikal: 1.81

Unterschrift des Schützen

Meyton Elektronik

Ergebnis: **370** (386.5)
 Serien: 92 95 94 89
 Zähler: 15 21 3 1 0 0 0 0 0 0
 Innenzehner: 9
 weiteste: 922 (38), 678 (28), 658 (5)
 beste Teiler 30.5 (17.) 57.3 (1.) 72.1 (21.)
 Trefferlage 0.08 mm links, 0.88 mm hoch
 Streuwert 2.55, horizontal: 2.57, vertikal: 2.53

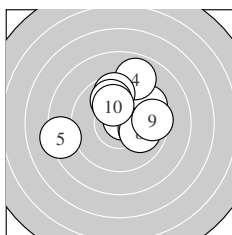
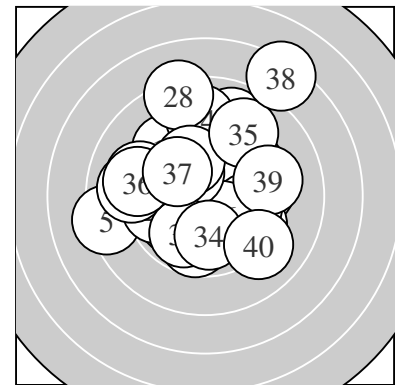

Serie 1:
 10.7 * 9.6 ↗ 10.1 → 8.9 ↑ 8.3 ←
 9.6 ↑ 9.9 ↘ 10.0 → 9.5 → 10.1 ↘
 beste Teiler 57.3 (1.) 206.2 (10.) 216.2 (3.)
 Trefferlage 0.42 mm rechts, 1.20 mm hoch
 Streuwert 2.48, horizontal: 2.87, vertikal: 2.01

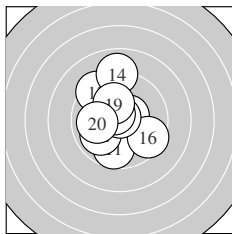

Serie 2:
 9.7 ↓ 9.9 ↗ 9.4 ↘ 9.0 ↑ 10.5 *
 9.5 ↘ 10.8 * 10.6 * 10.2 * 10.0 ←
 beste Teiler 30.5 (17.) 85.1 (18.) 108.2 (15.)
 Trefferlage 0.50 mm links, 0.45 mm hoch
 Streuwert 2.07, horizontal: 1.68, vertikal: 2.39

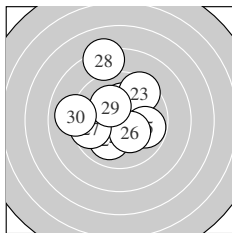

Serie 3:
 10.7 * 10.2 * 9.5 ↗ 10.0 ↓ 9.8 →
 10.3 * 9.6 ← 8.2 ↑ 10.2 * 9.0 ←
 beste Teiler 72.1 (21.) 169.4 (26.) 180.5 (22.)
 Trefferlage 0.53 mm links, 0.77 mm hoch
 Streuwert 2.45, horizontal: 2.33, vertikal: 2.57

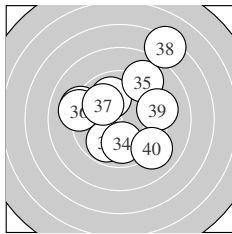

Serie 4:
 9.2 ↖ 9.8 ↓ 9.9 ↘ 9.9 ↓ 9.0 ↗
 9.2 ← 10.0 ↘ 7.3 ↗ 9.3 → 9.1 ↘
 beste Teiler 239.5 (37.) 251.0 (33.) 256.3 (34.)
 Trefferlage 0.25 mm rechts, 1.09 mm hoch
 Streuwert 3.35, horizontal: 3.37, vertikal: 3.32

Unterschrift des Schützen

Meyton Elektronik

Ergebnis: **375** (395.9)
 Serien: 94 93 94 94
 Zähler: 17 21 2 0 0 0 0 0 0 0
 Innenzehner: 13
 weiteste: 549 (13), 509 (10), 465 (4)
 beste Teiler 13.0 (9.) 35.0 (20.) 45.1 (12.)
 Trefferlage 0.07 mm rechts, 0.48 mm hoch
 Streuwert 2.08, horizontal: 2.42, vertikal: 1.68

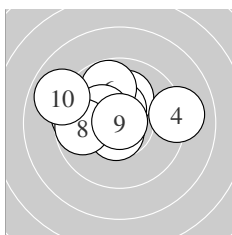
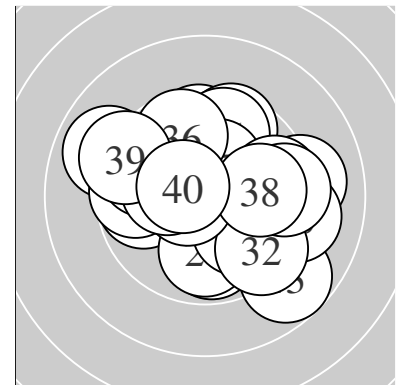

Serie 1:
 10.1 ↑ 10.5 * 10.6 * 9.1 → 9.6 ←
 9.8 ↑ 10.3 * 9.8 ← 10.9 * 8.9 ↖
 beste Teiler 13.0 (9.) 80.9 (3.) 114.2 (2.)
 Trefferlage 0.84 mm links, 0.92 mm hoch
 Streuwert 1.97, horizontal: 2.54, vertikal: 1.13

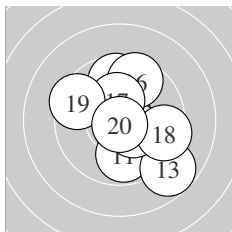

Serie 2:
 9.8 ↓ 10.8 * 8.8 ↘ 9.7 ↑ 10.4 *
 9.6 ↑ 10.3 * 9.5 → 9.5 ↖ 10.8 *
 beste Teiler 35.0 (20.) 45.1 (12.) 136.2 (15.)
 Trefferlage 0.66 mm rechts, 0.08 mm hoch
 Streuwert 2.21, horizontal: 2.07, vertikal: 2.34

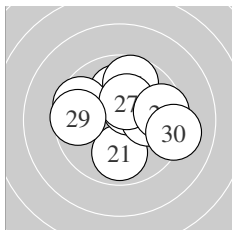

Serie 3:
 9.9 ↓ 10.4 * 10.1 ↑ 10.0 → 9.7 ↑
 9.6 ↖ 10.3 * 9.6 → 9.6 ← 9.2 →
 beste Teiler 130.4 (22.) 158.9 (27.) 223.1 (23.)
 Trefferlage 0.55 mm rechts, 0.64 mm hoch
 Streuwert 2.09, horizontal: 2.48, vertikal: 1.59

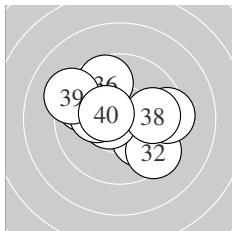

Serie 4:
 10.0 ↘ 9.5 ↘ 9.4 → 10.6 * 9.7 ↖
 9.7 ↑ 10.2 * 9.9 → 9.2 ↖ 10.5 *
 beste Teiler 85.5 (34.) 116.0 (40.) 185.3 (37.)
 Trefferlage 0.07 mm links, 0.30 mm hoch
 Streuwert 2.15, horizontal: 2.61, vertikal: 1.57

Unterschrift des Schützen

Meyton Elektronik

Ergebnis:	359	(375.9)
Serien:	86 90 93 90	
Zähler:	12 17 9 2 0 0 0 0 0 0	
Innenzehner:	8	
weiteste:	857 (8), 826 (12), 717 (37)	
beste Teiler	95.1 (14.) 97.6 (5.) 120.1 (22.)	
Trefferlage	1.19 mm links, 1.17 mm tief	
Streuwert	2.90, horizontal: 3.43, vertikal: 2.26	

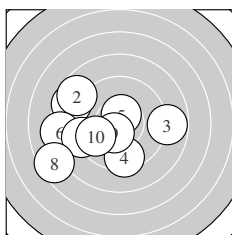
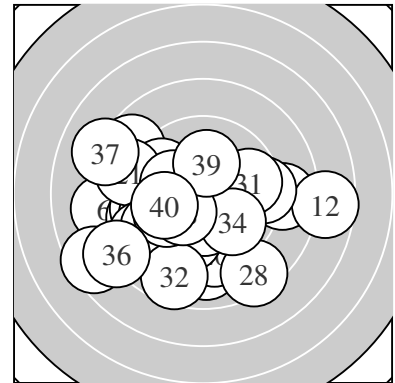

Serie 1:	8.6 ↖	8.7 ↖	8.8 →	9.4 ↓	10.6 *
	8.3 ←	9.1 ←	7.5 ↙	10.5 *	9.7 ↙
beste Teiler	97.6 (5.)	124.9 (9.)	304.7 (10.)		
Trefferlage	2.57 mm links, 0.73 mm tief				
Streuwert	3.25, horizontal: 3.93, vertikal: 2.37				

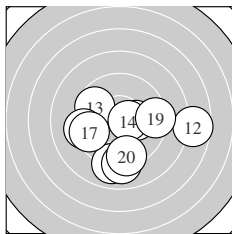

Serie 2:	10.2 *	7.6 →	9.7 ↖	10.6 *	9.0 ↓
	9.3 ←	9.5 ←	9.0 ↓	9.3 →	9.3 ↓
beste Teiler	95.1 (14.)	184.0 (11.)	316.2 (13.)		
Trefferlage	0.49 mm rechts, 1.51 mm tief				
Streuwert	3.07, horizontal: 3.70, vertikal: 2.27				

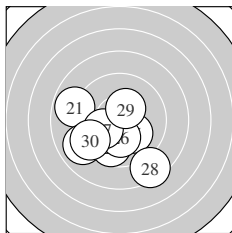

Serie 3:	8.9 ↖	10.5 *	9.0 ↙	9.7 ↓	10.1 ↘
	10.2 *	10.1 ↙	8.4 ↘	10.4 *	9.4 ↙
beste Teiler	120.1 (22.)	146.7 (29.)	193.3 (26.)		
Trefferlage	0.96 mm links, 1.61 mm tief				
Streuwert	2.34, horizontal: 2.64, vertikal: 2.00				

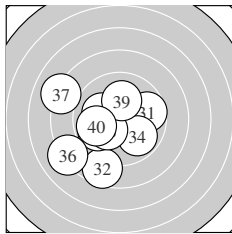

Serie 4:	9.7 →	8.6 ↓	9.8 ↙	9.9 ↘	10.1 ↖
	8.1 ↙	8.1 ↖	10.2 *	10.1 ↑	9.9 ←
beste Teiler	180.5 (38.)	207.2 (39.)	211.5 (35.)		
Trefferlage	1.74 mm links, 0.83 mm tief				
Streuwert	2.82, horizontal: 3.03, vertikal: 2.59				

Unterschrift des Schützen

Meyton Elektronik