

Ergebnis:	384	(400.9)
Serien:	95 95 98 96	
Zähler:	26 12 2 0 0 0 0 0 0 0	
Innenzehner:	19	
weiteste:	514 (1), 503 (31), 463 (34)	
beste Teiler	34.1 (28.) 36.3 (7.) 55.0 (33.)	
Trefferlage	0.19 mm links, 0.54 mm tief	
Streuwert	1.86, horizontal: 2.13, vertikal: 1.55	

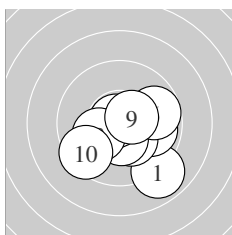

Serie 1:	8.9 ↘	10.5 *	9.9 →	10.3 *	10.4 *
	9.7 →	10.8 *	10.2 *	10.5 *	9.5 ↙
beste Teiler	36.3 (7.)	112.6 (9.)	115.4 (2.)		
Trefferlage	0.71 mm rechts, 0.89 mm tief				
Streuwert	1.75, horizontal: 1.96, vertikal: 1.49				

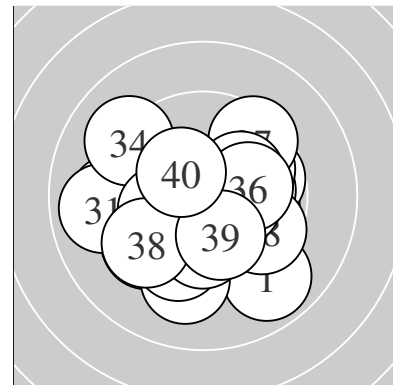
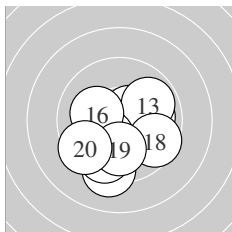

Serie 2:	10.0 →	10.5 *	9.9 ↗	10.3 *	9.2 ↓
	10.2 *	9.6 ↓	9.6 ↘	10.0 ↓	9.5 ↙
beste Teiler	104.4 (12.)	172.4 (14.)	199.6 (16.)		
Trefferlage	0.05 mm rechts, 1.21 mm tief				
Streuwert	1.93, horizontal: 2.01, vertikal: 1.84				

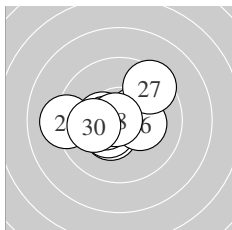

Serie 3:	10.4 *	10.4 *	10.4 *	10.4 *	10.5 *
	10.3 *	9.5 ↗	10.8 *	9.2 ←	10.1 ←
beste Teiler	34.1 (28.)	121.5 (25.)	130.8 (23.)		
Trefferlage	0.56 mm links, 0.03 mm hoch				
Streuwert	1.63, horizontal: 2.04, vertikal: 1.08				

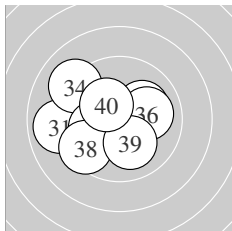

Serie 4:	8.9 ←	10.1 ↗	10.7 *	9.1 ↘	10.6 *
	10.0 →	10.1 ←	9.5 ↙	10.1 ↓	10.3 *
beste Teiler	55.0 (33.)	100.6 (35.)	162.0 (40.)		
Trefferlage	0.98 mm links, 0.09 mm tief				
Streuwert	2.03, horizontal: 2.41, vertikal: 1.54				

Unterschrift des Schützen

Meyton Elektronik

Ergebnis:	384	(402.9)
Serien:	94	100 94 96
Zähler:	26	12 2 0 0 0 0 0 0 0
Innenzehner:	23	
weiteste:	642	(10), 585 (29), 438 (38)
beste Teiler	14.0	(14.) 27.3 (22.) 69.0 (25.)
Trefferlage	0.24 mm links, 0.16 mm tief	
Streuwert	1.88, horizontal: 2.19, vertikal: 1.51	

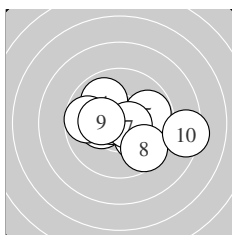
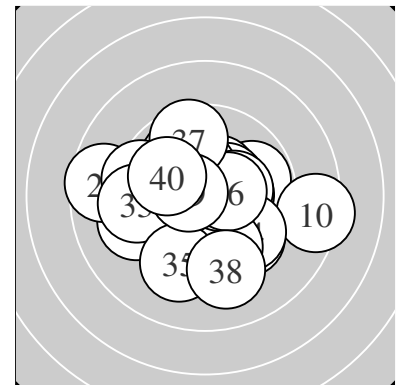

Serie 1:	10.1 ↘	10.3 *	10.6 *	9.9 ↖	9.8 →
	9.7 ←	10.6 *	9.6 ↘	10.3 *	8.4 →
beste Teiler	76.2 (3.) 89.0 (7.) 174.0 (2.)				
Trefferlage	0.51 mm rechts, 0.13 mm tief				
Streuwert	2.18, horizontal: 2.83, vertikal: 1.24				

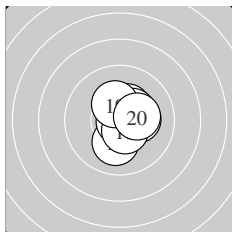

Serie 2:	10.5 *	10.1 ↓	10.4 *	10.9 *	10.5 *
	10.3 *	10.4 *	10.5 *	10.3 *	10.3 *
beste Teiler	14.0 (14.) 103.6 (15.) 110.4 (11.)				
Trefferlage	0.66 mm rechts, 0.20 mm hoch				
Streuwert	0.94, horizontal: 0.76, vertikal: 1.08				

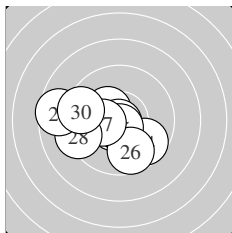

Serie 3:	10.4 *	10.8 *	10.6 *	9.7 ↘	10.7 *
	9.7 ↓	10.3 *	9.3 ←	8.6 ←	9.4 ←
beste Teiler	27.3 (22.) 69.0 (25.) 90.0 (23.)				
Trefferlage	1.34 mm links, 0.56 mm tief				
Streuwert	1.99, horizontal: 2.50, vertikal: 1.30				

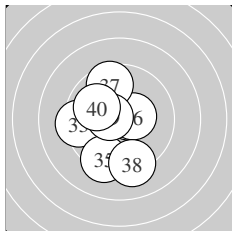

Serie 4:	10.6 *	10.3 *	9.4 ←	10.5 *	9.3 ↓
	10.4 *	9.6 ↗	9.2 ↓	10.6 *	10.0 ↖
beste Teiler	89.2 (31.) 96.1 (39.) 121.7 (34.)				
Trefferlage	0.83 mm links, 0.17 mm tief				
Streuwert	1.96, horizontal: 1.61, vertikal: 2.26				

Unterschrift des Schützen

Meyton Elektronik

Ergebnis: **355** (374.0)
 Serien: 87 89 87 92
 Zähler: 13 11 14 2 0 0 0 0 0 0
 Innenzehner: 11
 weiteste: 997 (11), 771 (27), 726 (20)
 beste Teiler 5.3 (12.) 33.2 (14.) 51.2 (28.)
 Trefferlage 0.63 mm rechts, 0.31 mm hoch
 Streuwert 3.30, horizontal: 3.82, vertikal: 2.68

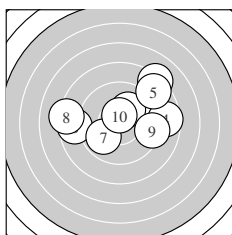
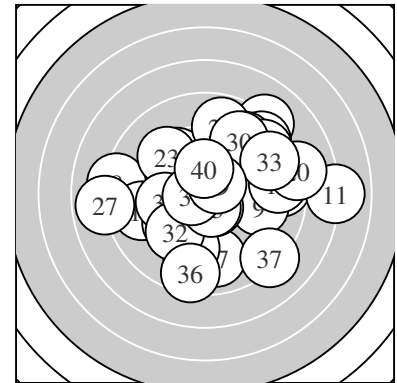

Serie 1:
 9.3 → 8.1 ↗ 10.1 ↗ 8.6 → 8.6 ↗
 8.7 ← 9.9 ↙ 8.2 ← 9.2 → 10.6 *
 beste Teiler 100.0 (10.) 202.8 (3.) 267.5 (7.)
 Trefferlage 0.94 mm rechts, 1.14 mm hoch
 Streuwert 3.54, horizontal: 4.51, vertikal: 2.16

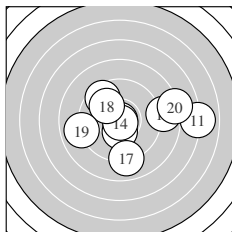

Serie 2:
 7.0 → 10.9 * 10.4 * 10.8 * 9.5 ↘
 8.7 → 9.0 ↓ 10.0 ↘ 8.9 ← 8.0 →
 beste Teiler 5.3 (12.) 33.2 (14.) 146.0 (13.)
 Trefferlage 1.49 mm rechts, 0.07 mm tief
 Streuwert 3.59, horizontal: 4.59, vertikal: 2.17

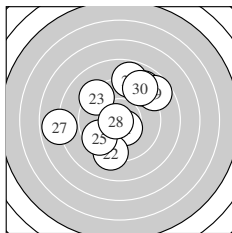

Serie 3:
 10.5 * 9.2 ↓ 9.3 ↘ 8.8 ↑ 9.6 ↘
 8.9 ↗ 7.9 ← 10.7 * 8.7 ↗ 9.0 ↗
 beste Teiler 51.2 (28.) 121.2 (21.) 339.5 (25.)
 Trefferlage 0.28 mm links, 1.12 mm hoch
 Streuwert 3.36, horizontal: 3.53, vertikal: 3.18

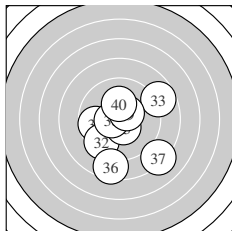

Serie 4:
 9.7 ← 9.5 ↙ 8.7 ↗ 10.6 * 10.5 *
 8.5 ↓ 8.2 ↘ 10.5 * 10.5 * 10.2 *
 beste Teiler 92.0 (34.) 102.1 (38.) 114.5 (35.)
 Trefferlage 0.36 mm rechts, 0.94 mm tief
 Streuwert 2.77, horizontal: 2.70, vertikal: 2.84

Unterschrift des Schützen

Ergebnis: **379** (395.3)
 Serien: 94 97 93 95
 Zähler: 21 17 2 0 0 0 0 0 0 0
 Innenzehner: 15
 weiteste: 667 (26), 526 (17), 495 (18)
 beste Teiler 22.5 (6.) 38.0 (13.) 82.2 (19.)
 Trefferlage 0.18 mm rechts, 0.29 mm tief
 Streuwert 2.17, horizontal: 2.40, vertikal: 1.91

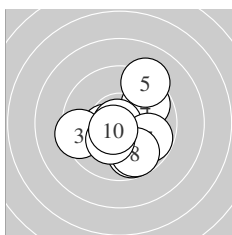
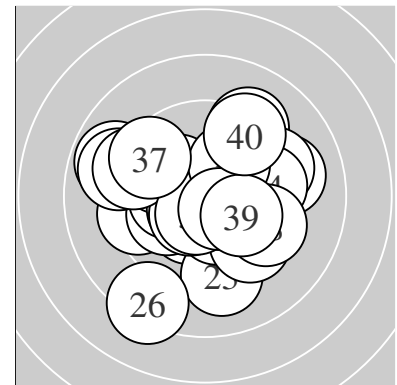

Serie 1:
 10.4 * 9.8 ↘ 9.4 ← 9.8 ↗ 9.2 ↗
 10.9 * 9.8 ↘ 9.8 ↘ 10.3 * 10.6 *
 beste Teiler 22.5 (6.) 84.1 (10.) 136.4 (1.)
 Trefferlage 0.32 mm rechts, 0.49 mm tief
 Streuwert 1.98, horizontal: 2.01, vertikal: 1.96

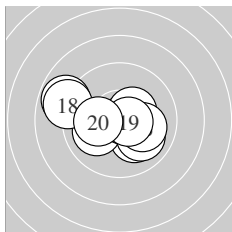

Serie 2:
 10.1 ↘ 10.0 ← 10.8 * 10.0 ↘ 10.4 *
 10.1 ↗ 8.8 ← 9.0 ← 10.6 * 10.2 *
 beste Teiler 38.0 (13.) 82.2 (19.) 139.7 (15.)
 Trefferlage 0.60 mm links, 0.09 mm tief
 Streuwert 2.05, horizontal: 2.65, vertikal: 1.18

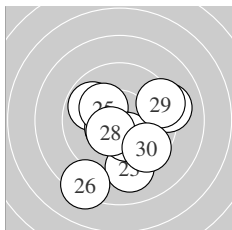

Serie 3:
 9.8 ↖ 9.1 → 9.2 ↓ 10.5 * 10.2 *
 8.3 ↙ 10.3 * 10.4 * 9.3 → 9.5 ↘
 beste Teiler 118.6 (24.) 132.2 (28.) 166.2 (27.)
 Trefferlage 0.32 mm rechts, 1.09 mm tief
 Streuwert 2.56, horizontal: 2.57, vertikal: 2.54

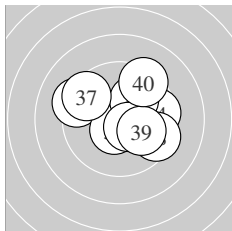

Serie 4:
 9.3 ↖ 10.4 * 10.5 * 9.6 → 10.1 ↗
 10.5 * 9.5 ↖ 9.5 ↘ 10.0 ↘ 9.3 ↗
 beste Teiler 106.1 (36.) 109.5 (33.) 141.8 (32.)
 Trefferlage 0.69 mm rechts, 0.51 mm hoch
 Streuwert 2.10, horizontal: 2.48, vertikal: 1.64

Unterschrift des Schützen

Ergebnis: **362** (379.4)
 Serien: 88 90 94 90
 Zähler: 15 15 8 1 1 0 0 0 0 0
 Innenzehner: 11
 weiteste: 1245 (21), 803 (4), 689 (14)
 beste Teiler 49.2 (36.) 78.0 (22.) 102.7 (26.)
 Trefferlage 0.54 mm links, 0.20 mm hoch
 Streuwert 3.08, horizontal: 3.63, vertikal: 2.41

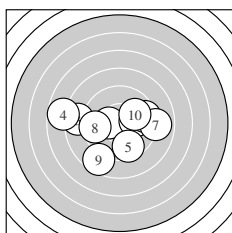
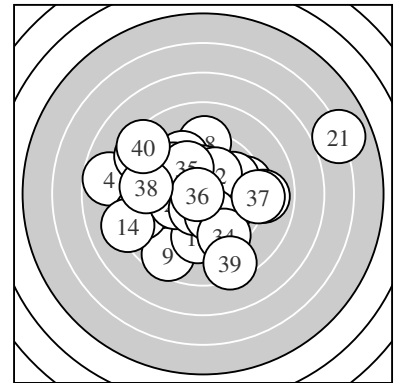

Serie 1:
 10.3 * 10.1 → 8.6 ← 7.7 ← 9.6 ↓
 9.5 → 8.9 → 9.6 ← 8.6 ↓ 10.0 →
 beste Teiler 151.0 (1.) 217.9 (2.) 248.1 (10.)
 Trefferlage 0.75 mm links, 0.47 mm tief
 Streuwert 3.36, horizontal: 4.27, vertikal: 2.08

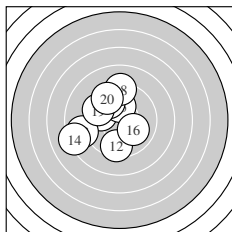

Serie 2:
 9.9 ← 9.5 ↓ 8.8 ← 8.2 ← 10.2 *
 10.0 ↘ 9.8 ↘ 9.2 ↑ 9.6 ↖ 9.5 ↖
 beste Teiler 193.0 (15.) 233.8 (16.) 271.0 (11.)
 Trefferlage 1.88 mm links, 0.47 mm hoch
 Streuwert 2.59, horizontal: 2.53, vertikal: 2.64

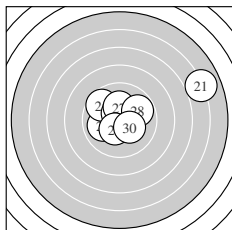

Serie 3:
 6.0 → 10.6 * 10.0 ← 10.4 * 9.6 ↖
 10.5 * 10.2 * 9.8 → 10.4 * 10.3 *
 beste Teiler 78.0 (22.) 102.7 (26.) 133.4 (24.)
 Trefferlage 1.12 mm rechts, 0.77 mm hoch
 Streuwert 3.10, horizontal: 3.96, vertikal: 1.89

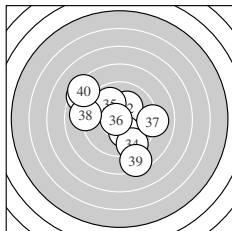

Serie 4:
 8.5 ↖ 10.2 * 10.2 * 9.4 ↓ 9.9 ↖
 10.8 * 9.1 → 9.0 ← 8.5 ↓ 8.4 ↖
 beste Teiler 49.2 (36.) 191.8 (33.) 197.9 (32.)
 Trefferlage 0.65 mm links, 0.03 mm hoch
 Streuwert 3.24, horizontal: 3.43, vertikal: 3.05

Unterschrift des Schützen

Meyton Elektronik

Ergebnis:	377	(395.9)
Serien:	95	92 95 95
Zähler:	18	21 1 0 0 0 0 0 0 0
Innenzehner:	15	
weiteste:	577	(37), 466 (23), 441 (36)
beste Teiler	32.2	(1.) 38.0 (31.) 75.8 (13.)
Trefferlage	0.32 mm	rechts, 0.90 mm hoch
Streuwert	1.96,	horizontal: 2.37, vertikal: 1.44

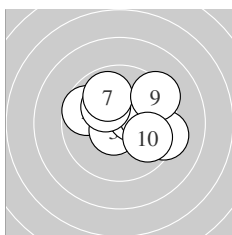
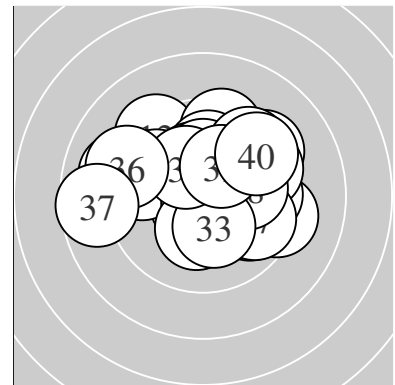

Serie 1:	10.8 *	9.7 ↖	10.6 *	10.4 *	10.0 →
	10.2 *	9.9 ↗	9.3 →	9.3 ↗	9.8 ↘
beste Teiler	32.2 (1.)	82.4 (3.)	134.6 (4.)		
Trefferlage	0.73 mm	rechts, 0.53 mm	hoch		
Streuwert	1.86,	horizontal: 2.25,	vertikal: 1.34		

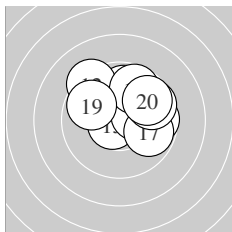

Serie 2:	9.9 ↑	9.3 ↖	10.7 *	10.3 *	9.7 →
	9.7 ↗	9.8 ↘	9.7 ↗	9.8 ↖	9.7 ↗
beste Teiler	75.8 (13.)	152.6 (14.)	273.2 (11.)		
Trefferlage	0.86 mm	rechts, 1.23 mm	hoch		
Streuwert	1.83,	horizontal: 2.15,	vertikal: 1.45		

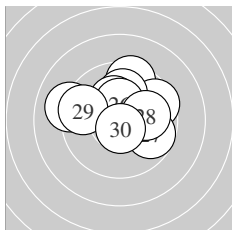

Serie 3:	9.5 ↑	9.6 ↗	9.1 ↖	10.0 ↑	10.2 *
	10.3 *	9.7 ↘	10.0 →	9.6 ↖	10.6 *
beste Teiler	76.4 (30.)	153.0 (26.)	183.8 (25.)		
Trefferlage	0.13 mm	rechts, 1.12 mm	hoch		
Streuwert	2.02,	horizontal: 2.49,	vertikal: 1.41		

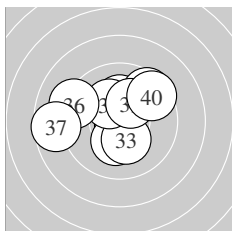

Serie 4:	10.8 *	10.2 *	10.3 *	10.2 *	10.2 *
	9.2 ↖	8.6 ←	9.5 ↗	10.2 *	9.5 ↗
beste Teiler	38.0 (31.)	175.2 (33.)	180.6 (32.)		
Trefferlage	0.42 mm	links, 0.71 mm	hoch		
Streuwert	2.23,	horizontal: 2.69,	vertikal: 1.64		

Unterschrift des Schützen

Meyton Elektronik

Ergebnis: **343** (363.7)
 Serien: 84 87 83 89
 Zähler: 10 14 9 3 4 0 0 0 0 0
 Innenzehner: 9
 weiteste: 1075 (10), 1056 (1), 1034 (28)
 beste Teiler 26.0 (14.) 70.1 (32.) 100.0 (2.)
 Trefferlage 1.15 mm rechts, 0.61 mm tief
 Streuwert 3.83, horizontal: 5.04, vertikal: 1.99

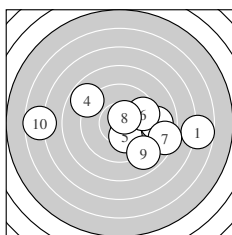
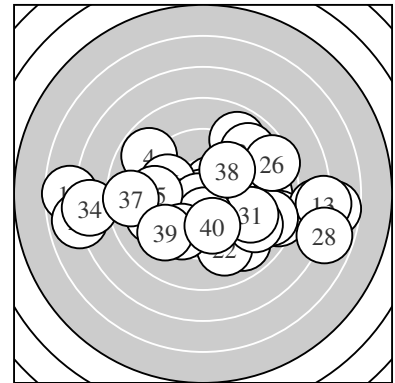

Serie 1:
 6.7 → 10.6 * 9.0 → 8.8 ↘ 10.2 *
 9.6 → 8.4 → 10.5 * 8.9 ↘ 6.7 ←
 beste Teiler 100.0 (2.) 102.9 (8.) 190.6 (5.)
 Trefferlage 1.52 mm rechts, 0.36 mm tief
 Streuwert 4.34, horizontal: 5.82, vertikal: 1.95

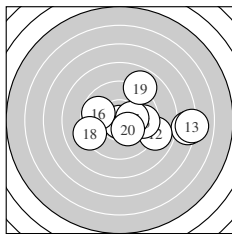

Serie 2:
 7.3 → 8.9 → 7.1 → 10.8 * 9.7 →
 9.7 ← 10.3 * 9.2 ← 8.9 ↗ 10.3 *
 beste Teiler 26.0 (14.) 162.7 (20.) 171.3 (17.)
 Trefferlage 2.55 mm rechts, 0.14 mm tief
 Streuwert 3.43, horizontal: 4.50, vertikal: 1.81

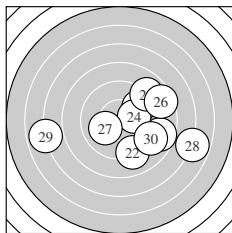

Serie 3:
 8.7 → 9.1 ↓ 9.7 ↗ 10.2 * 8.9 ↗
 8.5 → 10.1 ← 6.8 → 6.9 ← 9.0 →
 beste Teiler 200.8 (24.) 220.2 (27.) 312.9 (23.)
 Trefferlage 2.29 mm rechts, 0.70 mm tief
 Streuwert 4.17, horizontal: 5.27, vertikal: 2.63

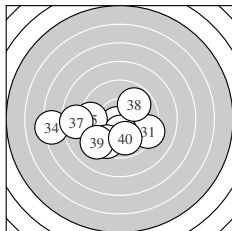

Serie 4:
 9.3 → 10.7 * 10.3 * 7.3 ← 9.4 ←
 9.6 ↙ 8.6 ← 9.9 ↗ 9.2 ↙ 9.9 ↓
 beste Teiler 70.1 (32.) 172.3 (33.) 267.7 (40.)
 Trefferlage 1.73 mm links, 1.22 mm tief
 Streuwert 2.94, horizontal: 3.86, vertikal: 1.56

Unterschrift des Schützen

Meyton Elektronik

Ergebnis: **373** (394.4)
 Serien: 91 96 94 92
 Zähler: 16 21 3 0 0 0 0 0 0 0
 Innenzehner: 14
 weiteste: 734 (25), 541 (33), 502 (4)
 beste Teiler 11.0 (6.) 50.7 (29.) 58.5 (3.)
 Trefferlage 0.19 mm links, 0.55 mm tief
 Streuwert 2.20, horizontal: 2.12, vertikal: 2.27

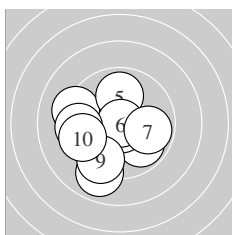
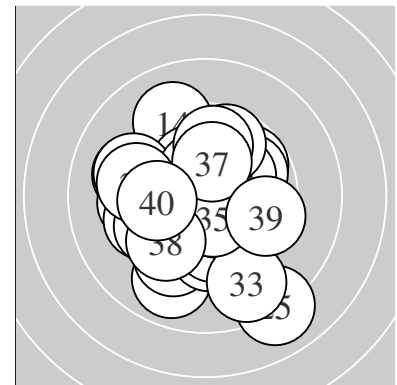

Serie 1:
 9.2 ↙ 9.9 ↘ 10.7 * 8.9 ↓ 9.9 ↑
 10.9 * 9.9 → 9.4 ← 9.4 ↓ 9.5 ←
 beste Teiler 11.0 (6.) 58.5 (3.) 257.0 (5.)
 Trefferlage 1.02 mm links, 0.91 mm tief
 Streuwert 2.25, horizontal: 2.39, vertikal: 2.09

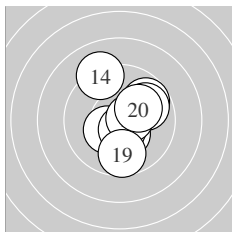

Serie 2:
 10.1 ↓ 10.4 * 9.7 ↗ 9.1 ↖ 10.4 *
 9.9 ↗ 10.6 * 10.6 * 9.7 ↓ 10.1 ↗
 beste Teiler 91.2 (17.) 96.5 (18.) 144.4 (12.)
 Trefferlage 0.59 mm rechts, 0.00 mm
 Streuwert 1.82, horizontal: 1.41, vertikal: 2.15

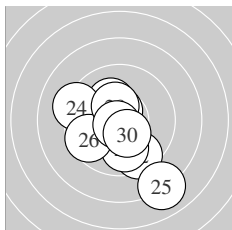

Serie 3:
 10.2 * 9.5 ↘ 9.9 ↓ 9.2 ↖ 8.0 ↘
 9.6 ↖ 10.6 * 10.4 * 10.8 * 10.4 *
 beste Teiler 50.7 (29.) 88.3 (27.) 139.4 (28.)
 Trefferlage 0.16 mm links, 1.02 mm tief
 Streuwert 2.39, horizontal: 2.24, vertikal: 2.52

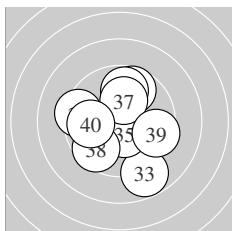

Serie 4:
 9.7 ↗ 10.2 * 8.8 ↘ 9.4 ↖ 10.4 *
 9.8 ↑ 10.2 * 9.6 ↖ 9.5 → 9.9 ←
 beste Teiler 127.2 (35.) 193.0 (32.) 196.9 (37.)
 Trefferlage 0.19 mm links, 0.29 mm tief
 Streuwert 2.39, horizontal: 2.31, vertikal: 2.47

Unterschrift des Schützen

Ergebnis: **392** (409.4)
 Serien: 100 97 99 96
 Zähler: 32 8 0 0 0 0 0 0 0 0
 Innenzehner: 27
 weiteste: 491 (40), 406 (39), 380 (38)
 beste Teiler 49.8 (21.) 55.8 (20.) 71.5 (6.)
 Trefferlage 0.15 mm links, 0.33 mm tief
 Streuwert 1.44, horizontal: 1.50, vertikal: 1.38

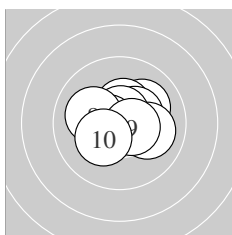
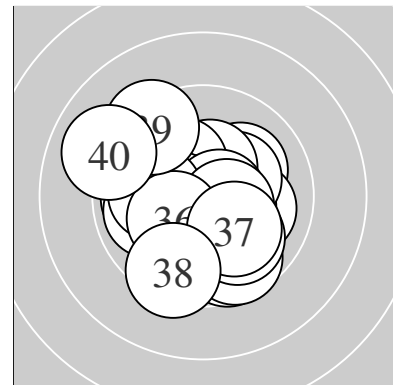

Serie 1:
 10.7 * 10.1 ↗ 10.4 * 10.4 * 10.1 →
 10.7 * 10.6 * 10.1 ← 10.6 * 10.3 *
 beste Teiler 71.5 (6.) 72.1 (1.) 92.0 (7.)
 Trefferlage 0.22 mm rechts, 0.32 mm hoch
 Streuwert 1.11, horizontal: 1.36, vertikal: 0.80

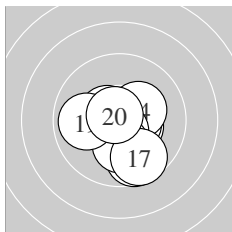

Serie 2:
 9.7 ↓ 10.4 * 10.5 * 10.3 * 10.6 *
 10.2 * 9.6 ↓ 10.5 * 9.9 ← 10.7 *
 beste Teiler 55.8 (20.) 85.1 (15.) 110.3 (13.)
 Trefferlage 0.25 mm rechts, 0.78 mm tief
 Streuwert 1.35, horizontal: 1.32, vertikal: 1.38

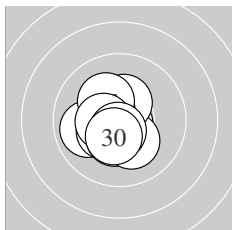

Serie 3:
 10.8 * 9.9 ← 10.4 * 10.4 * 10.2 *
 10.4 * 10.2 * 10.4 * 10.6 * 10.4 *
 beste Teiler 49.8 (21.) 85.1 (29.) 127.6 (28.)
 Trefferlage 0.53 mm links, 0.42 mm tief
 Streuwert 1.04, horizontal: 1.00, vertikal: 1.08

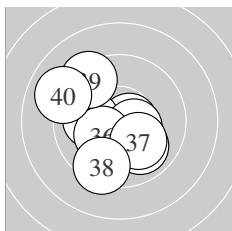

Serie 4:
 10.2 * 10.6 * 9.9 ↘ 10.0 ← 10.5 *
 10.3 * 10.1 ↘ 9.4 ↓ 9.3 ↘ 9.0 ↖
 beste Teiler 76.1 (32.) 122.6 (35.) 173.8 (36.)
 Trefferlage 0.56 mm links, 0.46 mm tief
 Streuwert 2.04, horizontal: 2.11, vertikal: 1.96

Unterschrift des Schützen

Meyton Elektronik

Ergebnis: **393** (410.5)
 Serien: 99 98 98 98
 Zähler: 33 7 0 0 0 0 0 0 0 0
 Innenzehner: 28
 weiteste: 413 (20), 366 (33), 288 (5)
 beste Teiler 29.8 (31.) 32.2 (14.) 44.1 (2.)
 Trefferlage 0.23 mm rechts, 0.30 mm hoch
 Streuwert 1.33, horizontal: 1.23, vertikal: 1.43

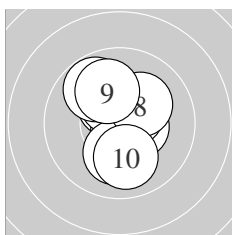
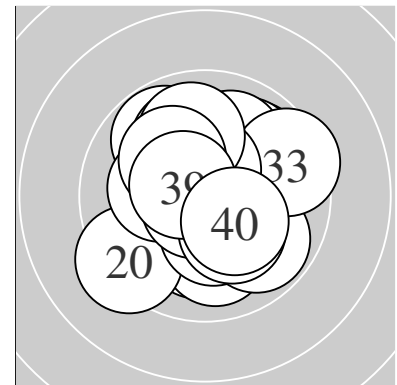

Serie 1:
 10.4 * 10.8 * 10.5 * 10.3 * 9.8 ↖
 10.5 * 10.1 ↓ 10.2 * 10.0 ↗ 10.0 ↓
 beste Teiler 44.1 (2.) 105.6 (6.) 122.3 (3.)
 Trefferlage 0.00 mm , 0.42 mm hoch
 Streuwert 1.36, horizontal: 0.99, vertikal: 1.65

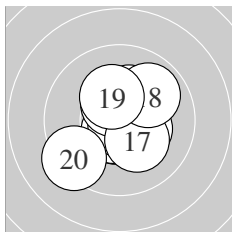

Serie 2:
 10.6 * 10.3 * 10.6 * 10.8 * 10.3 *
 10.5 * 10.2 * 9.9 ↗ 10.3 * 9.3 ↙
 beste Teiler 32.2 (14.) 86.3 (11.) 87.8 (13.)
 Trefferlage 0.04 mm rechts, 0.04 mm tief
 Streuwert 1.46, horizontal: 1.44, vertikal: 1.49

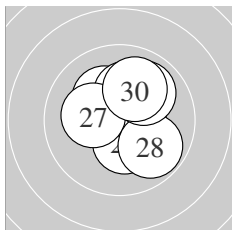

Serie 3:
 10.2 * 10.4 * 10.5 * 10.2 * 10.5 *
 10.3 * 10.2 * 9.8 ↘ 9.9 ↗ 10.0 ↗
 beste Teiler 105.3 (23.) 121.4 (25.) 128.1 (22.)
 Trefferlage 0.51 mm rechts, 0.48 mm hoch
 Streuwert 1.33, horizontal: 1.18, vertikal: 1.47

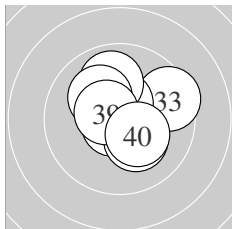

Serie 4:
 10.8 * 10.6 * 9.5 ↗ 10.7 * 10.5 *
 9.9 ↗ 10.2 * 10.1 ↘ 10.5 * 10.3 *
 beste Teiler 29.8 (31.) 55.3 (34.) 94.3 (32.)
 Trefferlage 0.36 mm rechts, 0.35 mm hoch
 Streuwert 1.31, horizontal: 1.37, vertikal: 1.25

Unterschrift des Schützen

Meyton Elektronik

Ergebnis: **383** (399.3)
 Serien: 96 96 95 96
 Zähler: 23 17 0 0 0 0 0 0 0 0
 Innenzehner: 13
 weiteste: 468 (8), 446 (5), 437 (38)
 beste Teiler 32.0 (29.) 44.1 (3.) 58.1 (39.)
 Trefferlage 0.28 mm rechts, 1.02 mm hoch
 Streuwert 1.76, horizontal: 1.51, vertikal: 1.97

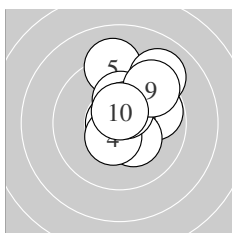
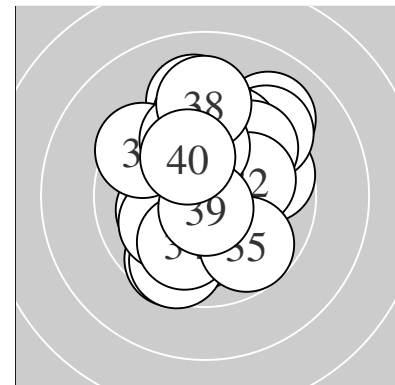

Serie 1:
 9.8 → 10.3 * 10.8 * 10.5 * 9.2 ↑
 10.2 * 10.5 * 9.1 ↗ 9.5 ↗ 10.6 *
 beste Teiler 44.1 (3.) 93.0 (10.) 110.5 (7.)
 Trefferlage 0.83 mm rechts, 1.32 mm hoch
 Streuwert 1.65, horizontal: 1.40, vertikal: 1.86

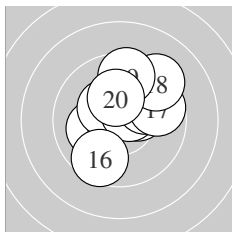

Serie 2:
 10.1 ← 10.4 * 10.3 * 10.6 * 10.0 ↘
 9.6 ↓ 9.7 → 9.3 ↗ 9.6 ↑ 10.2 *
 beste Teiler 95.0 (14.) 146.6 (12.) 155.0 (13.)
 Trefferlage 0.56 mm rechts, 0.88 mm hoch
 Streuwert 1.79, horizontal: 1.78, vertikal: 1.81

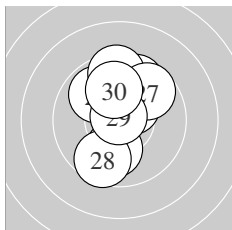

Serie 3:
 9.7 ↗ 10.1 ↗ 10.0 ↓ 9.9 ↘ 10.4 *
 9.5 ↑ 9.7 ↗ 9.6 ↓ 10.8 * 10.0 ↑
 beste Teiler 32.0 (29.) 143.2 (25.) 214.2 (22.)
 Trefferlage 0.10 mm rechts, 1.12 mm hoch
 Streuwert 1.78, horizontal: 1.22, vertikal: 2.20

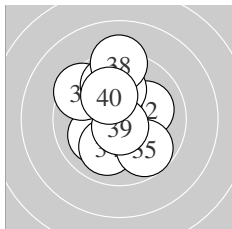

Serie 4:
 10.1 ← 10.1 → 9.5 ↘ 10.0 ↓ 9.8 ↘
 9.8 ↑ 10.0 ↑ 9.2 ↑ 10.7 * 10.1 ↘
 beste Teiler 58.1 (39.) 201.4 (40.) 217.6 (32.)
 Trefferlage 0.35 mm links, 0.78 mm hoch
 Streuwert 1.93, horizontal: 1.53, vertikal: 2.26

Unterschrift des Schützen

Ergebnis: **394** (413.2)
 Serien: 99 98 99 98
 Zähler: 34 6 0 0 0 0 0 0 0 0
 Innenzehner: 30
 weiteste: 295 (35), 292 (2), 266 (12)
 beste Teiler 3.1 (26.) 32.0 (9.) 35.5 (28.)
 Trefferlage 0.16 mm links, 0.23 mm hoch
 Streuwert 1.23, horizontal: 1.48, vertikal: 0.90

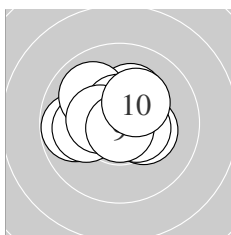
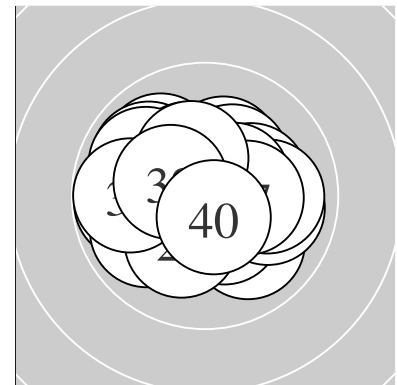

Serie 1:
 10.2 * 9.8 ← 10.1 ← 10.3 * 10.0 ↖
 10.5 * 10.6 * 10.4 * 10.8 * 10.3 *
 beste Teiler 32.0 (9.) 96.5 (7.) 116.4 (6.)
 Trefferlage 0.37 mm links, 0.43 mm hoch
 Streuwert 1.28, horizontal: 1.56, vertikal: 0.92

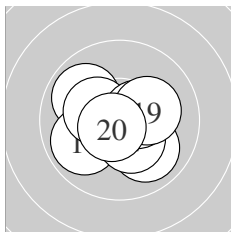

Serie 2:
 10.0 ↘ 9.9 ↖ 10.5 * 9.9 ↙ 10.5 *
 10.3 * 10.4 * 10.5 * 10.2 * 10.7 *
 beste Teiler 69.3 (20.) 108.1 (13.) 118.6 (15.)
 Trefferlage 0.09 mm links, 0.16 mm tief
 Streuwert 1.35, horizontal: 1.60, vertikal: 1.04

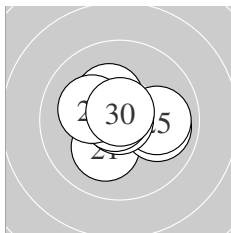

Serie 3:
 10.2 * 10.5 * 9.9 → 10.3 * 10.0 →
 10.9 * 10.3 * 10.8 * 10.2 * 10.7 *
 beste Teiler 3.1 (26.) 35.5 (28.) 54.0 (30.)
 Trefferlage 0.02 mm links, 0.28 mm hoch
 Streuwert 1.20, horizontal: 1.41, vertikal: 0.94

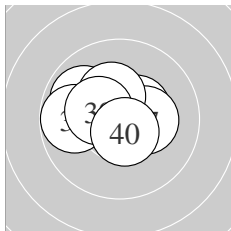

Serie 4:
 10.5 * 10.7 * 9.9 ↖ 10.4 * 9.8 ←
 10.6 * 10.3 * 10.3 * 10.4 * 10.6 *
 beste Teiler 70.6 (32.) 90.6 (40.) 96.3 (36.)
 Trefferlage 0.17 mm links, 0.37 mm hoch
 Streuwert 1.21, horizontal: 1.56, vertikal: 0.69

Unterschrift des Schützen

Ergebnis: **384** (401.9)
 Serien: 95 97 96 96
 Zähler: 25 14 1 0 0 0 0 0 0 0
 Innenzehner: 21
 weiteste: 606 (1), 487 (38), 427 (36)
 beste Teiler 34.7 (27.) 45.6 (4.) 64.0 (30.)
 Trefferlage 0.14 mm links, 0.10 mm tief
 Streuwert 1.83, horizontal: 1.93, vertikal: 1.72

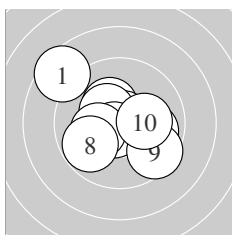
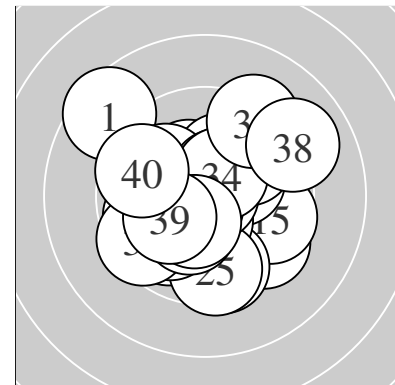

Serie 1:
 8.5 ↘ 9.9 → 10.3 * 10.8 * 10.4 *
 10.7 * 10.2 * 9.8 ↙ 9.5 ↘ 10.2 *
 beste Teiler 45.6 (4.) 69.0 (6.) 137.2 (5.)
 Trefferlage 0.33 mm links, 0.11 mm hoch
 Streuwert 2.05, horizontal: 2.32, vertikal: 1.74

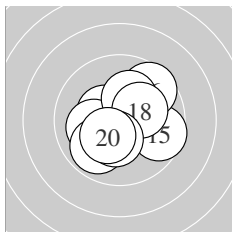

Serie 2:
 10.1 ↗ 10.4 * 10.1 ← 9.9 ↙ 9.6 →
 9.6 ↗ 10.2 * 10.2 * 10.3 * 10.3 *
 beste Teiler 133.3 (12.) 154.0 (19.) 156.2 (20.)
 Trefferlage 0.29 mm rechts, 0.06 mm hoch
 Streuwert 1.68, horizontal: 1.81, vertikal: 1.54

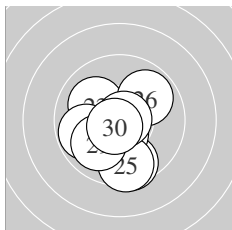

Serie 3:
 10.7 * 9.5 ↓ 10.0 ↘ 10.5 * 9.5 ↓
 9.9 ↗ 10.8 * 9.8 ← 10.0 ↙ 10.7 *
 beste Teiler 34.7 (27.) 64.0 (30.) 73.6 (21.)
 Trefferlage 0.34 mm links, 0.87 mm tief
 Streuwert 1.58, horizontal: 1.42, vertikal: 1.73

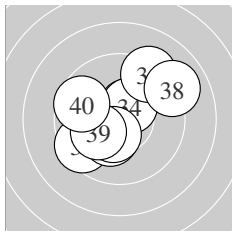

Serie 4:
 10.5 * 9.5 ↙ 10.4 * 10.4 * 10.3 *
 9.2 ↗ 10.4 * 9.0 ↗ 10.2 * 9.6 ↖
 beste Teiler 113.0 (31.) 127.5 (33.) 132.2 (34.)
 Trefferlage 0.21 mm links, 0.27 mm hoch
 Streuwert 2.08, horizontal: 2.28, vertikal: 1.87

Unterschrift des Schützen

Meyton Elektronik

Ergebnis:	392	(409.5)
Serien:	95	100 98 99
Zähler:	33 6	1 0 0 0 0 0 0 0
Innenzehner:	27	
weiteste:	552 (7), 364 (4), 335 (9)	
beste Teiler	40.4 (36.)	55.9 (26.) 71.2 (28.)
Trefferlage	0.04 mm rechts, 0.69 mm hoch	
Streuwert	1.37, horizontal: 1.71, vertikal: 0.91	

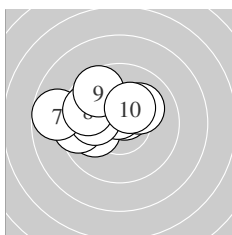
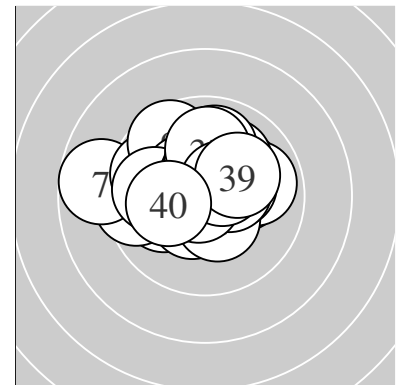

Serie 1:

10.0 ←	10.6 *	10.1 ↗	9.5 ←	10.6 *
10.1 ←	8.7 ←	9.8 ←	9.6 ↖	10.3 *
beste Teiler	84.5 (5.)	87.3 (2.)	162.8 (10.)	
Trefferlage	1.51 mm links, 0.81 mm hoch			
Streuwert	1.72, horizontal: 2.22, vertikal: 0.98			

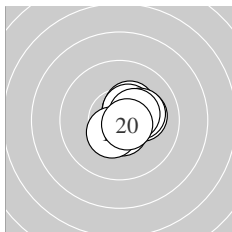

Serie 2:

10.5 *	10.5 *	10.2 *	10.6 *	10.4 *
10.5 *	10.2 *	10.4 *	10.4 *	10.7 *
beste Teiler	75.6 (20.)	92.6 (14.)	102.6 (11.)	
Trefferlage	0.83 mm rechts, 0.29 mm hoch			
Streuwert	0.77, horizontal: 0.75, vertikal: 0.80			

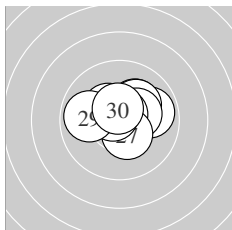

Serie 3:

10.2 *	9.9 →	10.2 *	10.4 *	10.3 *
10.7 *	10.4 *	10.7 *	9.9 ←	10.5 *
beste Teiler	55.9 (26.)	71.2 (28.)	102.2 (30.)	
Trefferlage	0.33 mm rechts, 0.59 mm hoch			
Streuwert	1.19, horizontal: 1.51, vertikal: 0.73			

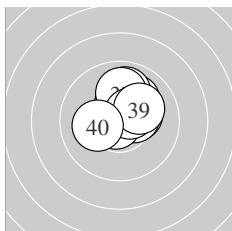

Serie 4:

10.3 *	10.3 *	10.4 *	10.1 ↗	9.9 ↑
10.8 *	10.0 ↑	10.5 *	10.1 ↗	10.2 *
beste Teiler	40.4 (36.)	112.4 (38.)	132.4 (33.)	
Trefferlage	0.51 mm rechts, 1.05 mm hoch			
Streuwert	1.07, horizontal: 1.10, vertikal: 1.05			

Unterschrift des Schützen

Ergebnis:	378	(397.6)
Serien:	92 92 98 96	
Zähler:	21 16 3 0 0 0 0 0 0 0	
Innenzehner:	17	
weiteste:	624 (14), 621 (15), 569 (8)	
beste Teiler	40.0 (25.) 43.6 (12.) 70.4 (38.)	
Trefferlage	0.02 mm rechts, 0.63 mm hoch	
Streuwert	2.03, horizontal: 2.31, vertikal: 1.69	

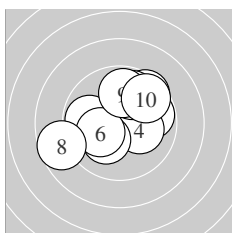
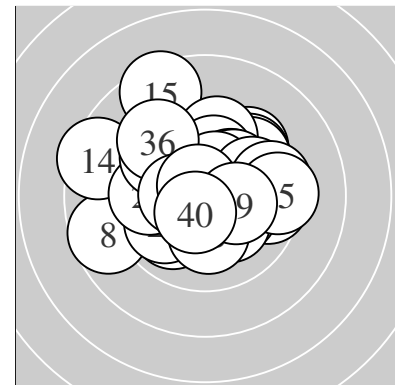

Serie 1:	9.5 ↗	9.8 ←	9.8 →	10.2 *	10.2 *
	10.2 *	9.8 ↑	8.7 ←	9.8 ↑	9.6 ↗
beste Teiler	191.3 (4.)	193.9 (5.)	194.5 (6.)		
Trefferlage	0.02 mm links, 0.64 mm hoch				
Streuwert	2.29, horizontal: 2.67, vertikal: 1.84				

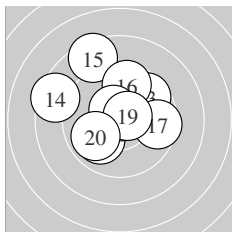

Serie 2:	10.0 ↘	10.8 *	9.7 ↗	8.5 ↖	8.5 ↘
	9.6 ↑	9.6 →	10.5 *	10.6 *	9.9 ↙
beste Teiler	43.6 (12.)	82.7 (19.)	110.7 (18.)		
Trefferlage	0.53 mm links, 1.11 mm hoch				
Streuwert	2.49, horizontal: 2.69, vertikal: 2.26				

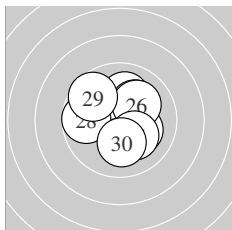

Serie 3:	10.2 *	10.3 *	10.1 ↑	10.2 *	10.8 *
	10.1 ↗	10.2 *	9.7 ←	9.7 ↖	10.1 ↓
beste Teiler	40.0 (25.)	161.6 (22.)	195.2 (27.)		
Trefferlage	0.03 mm links, 0.30 mm hoch				
Streuwert	1.62, horizontal: 1.74, vertikal: 1.49				

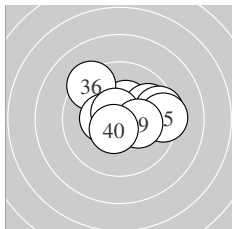

Serie 4:	10.4 *	9.8 →	10.6 *	9.5 →	9.4 →
	9.3 ↘	10.4 *	10.7 *	10.3 *	10.5 *
beste Teiler	70.4 (38.)	85.8 (33.)	105.8 (40.)		
Trefferlage	0.69 mm rechts, 0.49 mm hoch				
Streuwert	1.76, horizontal: 2.20, vertikal: 1.16				

Unterschrift des Schützen

Meyton Elektronik

Ergebnis: **385** (401.8)
 Serien: 96 97 95 97
 Zähler: 26 13 1 0 0 0 0 0 0 0
 Innenzehner: 18
 weiteste: 534 (23), 411 (24), 383 (39)
 beste Teiler 54.8 (38.) 93.6 (17.) 97.0 (20.)
 Trefferlage 0.45 mm rechts, 0.02 mm hoch
 Streuwert 1.74, horizontal: 1.93, vertikal: 1.53

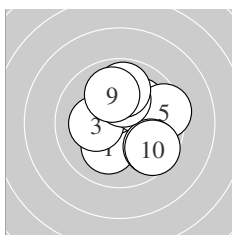
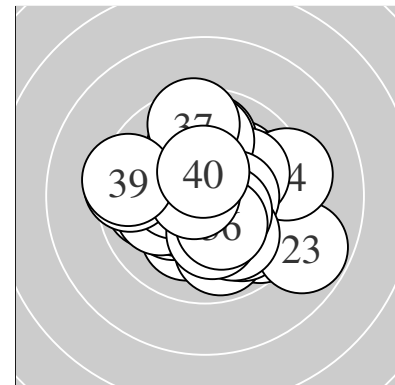

Serie 1:
 10.1 ↙ 10.4 * 10.2 * 10.1 ↗ 9.5 →
 9.7 ↘ 10.2 * 9.9 ↑ 10.0 ↑ 9.6 ↘
 beste Teiler 143.6 (2.) 190.0 (3.) 195.3 (7.)
 Trefferlage 0.71 mm rechts, 0.49 mm hoch
 Streuwert 1.81, horizontal: 1.79, vertikal: 1.83

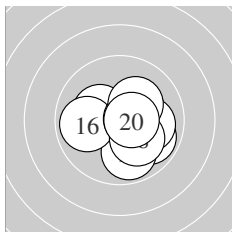

Serie 2:
 10.3 * 9.9 ↘ 10.3 * 10.0 → 9.9 ↓
 9.9 ← 10.6 * 10.1 ↘ 10.2 * 10.6 *
 beste Teiler 93.6 (17.) 97.0 (20.) 162.3 (13.)
 Trefferlage 0.72 mm rechts, 0.33 mm tief
 Streuwert 1.41, horizontal: 1.61, vertikal: 1.18

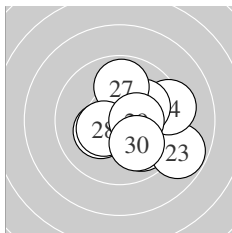

Serie 3:
 10.3 * 9.9 ↘ 8.8 ↘ 9.3 → 10.1 →
 10.2 * 9.9 ↑ 10.4 * 10.4 * 10.0 ↘
 beste Teiler 137.0 (29.) 145.4 (28.) 159.0 (21.)
 Trefferlage 1.38 mm rechts, 0.22 mm tief
 Streuwert 1.82, horizontal: 1.98, vertikal: 1.65

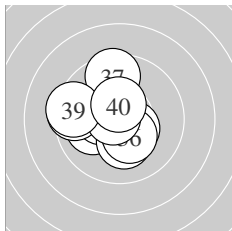

Serie 4:
 10.1 ← 10.4 * 10.4 * 10.2 * 9.5 ←
 10.3 * 9.5 ↑ 10.7 * 9.4 ← 10.5 *
 beste Teiler 54.8 (38.) 118.3 (40.) 127.2 (32.)
 Trefferlage 1.00 mm links, 0.16 mm hoch
 Streuwert 1.61, horizontal: 1.72, vertikal: 1.50

Unterschrift des Schützen

Meyton Elektronik

Ergebnis: **349** (368.0)
 Serien: 91 86 87 85
 Zähler: 11 14 10 3 2 0 0 0 0 0
 Innenzehner: 8
 weiteste: 1098 (12), 1011 (40), 880 (19)
 beste Teiler 14.5 (17.) 82.0 (5.) 119.9 (38.)
 Trefferlage 0.28 mm links, 0.93 mm hoch
 Streuwert 3.55, horizontal: 4.30, vertikal: 2.61

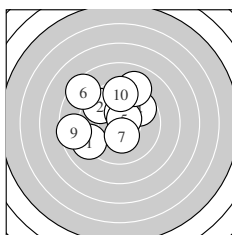
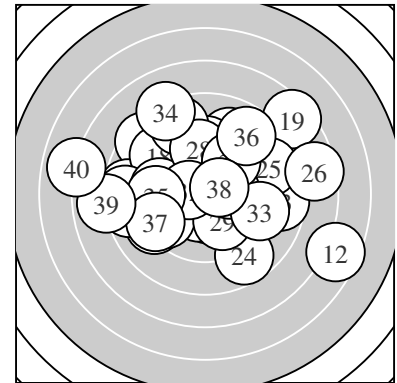

Serie 1:
 9.1 ↙ 9.6 ↘ 10.4 * 9.7 ↗ 10.6 *
 8.5 ↘ 10.3 * 9.1 ↑ 8.6 ← 9.5 ↑
 beste Teiler 82.0 (5.) 141.9 (3.) 160.6 (7.)
 Trefferlage 1.13 mm links, 1.31 mm hoch
 Streuwert 2.65, horizontal: 2.88, vertikal: 2.40

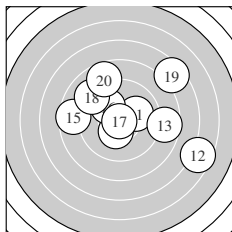

Serie 2:
 10.1 → 6.6 ↘ 8.6 → 10.4 * 8.6 ←
 10.0 ↘ 10.9 * 9.1 ↘ 7.4 ↗ 8.7 ↘
 beste Teiler 14.5 (17.) 150.2 (14.) 224.5 (11.)
 Trefferlage 1.10 mm rechts, 1.03 mm hoch
 Streuwert 4.15, horizontal: 5.00, vertikal: 3.07

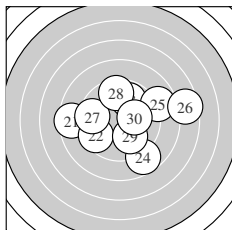

Serie 3:
 8.5 ← 9.5 ↙ 9.8 ↑ 8.7 ↘ 8.8 →
 7.5 → 9.5 ← 9.6 ↑ 10.0 ↘ 10.2 *
 beste Teiler 194.0 (30.) 246.5 (29.) 280.1 (23.)
 Trefferlage 0.75 mm rechts, 0.18 mm hoch
 Streuwert 3.50, horizontal: 4.27, vertikal: 2.50

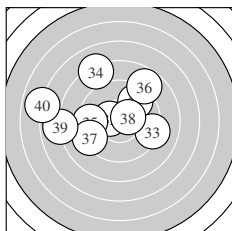

Serie 4:
 9.7 ↗ 10.4 * 9.2 ↘ 8.1 ↘ 9.4 ←
 8.8 ↗ 9.2 ↙ 10.5 * 7.9 ← 6.9 ←
 beste Teiler 119.9 (38.) 127.5 (32.) 320.0 (31.)
 Trefferlage 1.89 mm links, 1.18 mm hoch
 Streuwert 3.78, horizontal: 4.63, vertikal: 2.66

Unterschrift des Schützen

Meyton Elektronik

Ergebnis: **346** (360.5)
 Serien: 80 90 89 87
 Zähler: 6 22 6 5 0 1 0 0 0 0
 Innenzehner: 2
 weiteste: 1403 (1), 949 (2), 933 (4)
 beste Teiler 146.7 (8.) 181.8 (21.) 206.2 (26.)
 Trefferlage 0.81 mm rechts, 0.29 mm tief
 Streuwert 3.89, horizontal: 3.82, vertikal: 3.96

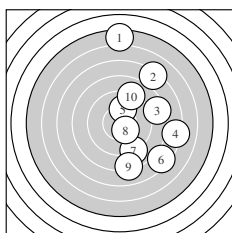
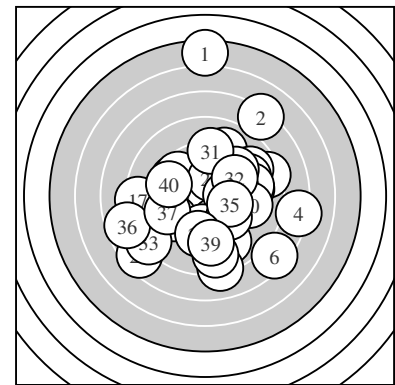

Serie 1:
 5.3 ↑ 7.2 ↗ 8.4 → 7.2 → 10.0 ↑
 7.4 ↘ 9.0 ↘ 10.4 * 8.1 ↓ 9.0 ↑
 beste Teiler 146.7 (8.) 236.2 (5.) 483.0 (10.)
 Trefferlage 3.47 mm rechts, 1.04 mm hoch
 Streuwert 5.13, horizontal: 3.16, vertikal: 6.53

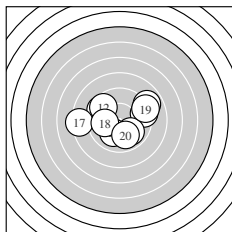

Serie 2:
 9.5 ↖ 9.6 ↖ 9.3 → 8.9 ↗ 9.9 ↘
 10.0 ↓ 8.3 ← 10.0 ← 9.1 → 9.9 ↓
 beste Teiler 229.4 (16.) 246.1 (18.) 258.1 (15.)
 Trefferlage 0.03 mm links, 0.22 mm hoch
 Streuwert 2.95, horizontal: 3.72, vertikal: 1.89

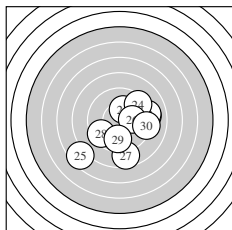

Serie 3:
 10.2 * 9.1 → 9.1 → 9.4 ↗ 7.5 ↙
 10.1 → 8.6 ↓ 9.5 ↙ 9.7 ↓ 9.2 →
 beste Teiler 181.8 (21.) 206.2 (26.) 308.3 (29.)
 Trefferlage 1.03 mm rechts, 1.16 mm tief
 Streuwert 3.28, horizontal: 3.57, vertikal: 2.97

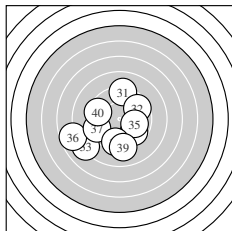

Serie 4:
 9.2 ↑ 9.6 ↗ 8.1 ↙ 9.7 ↘ 9.9 →
 7.7 ← 9.4 ← 9.4 ↓ 9.1 ↓ 9.5 ←
 beste Teiler 255.8 (35.) 312.4 (34.) 339.2 (32.)
 Trefferlage 1.23 mm links, 1.26 mm tief
 Streuwert 3.33, horizontal: 3.67, vertikal: 2.95

Unterschrift des Schützen

Meyton Elektronik

Ergebnis: **341** (357.7)
 Serien: 85 85 81 90
 Zähler: 12 11 6 9 1 1 0 0 0 0
 Innenzehner: 9
 weiteste: 1423 (22), 1099 (27), 996 (24)
 beste Teiler 62.1 (39.) 126.5 (17.) 126.8 (23.)
 Trefferlage 0.47 mm links, 0.25 mm tief
 Streuwert 4.25, horizontal: 5.30, vertikal: 2.84

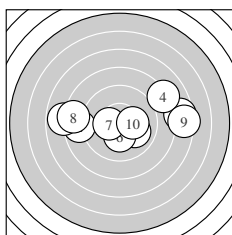
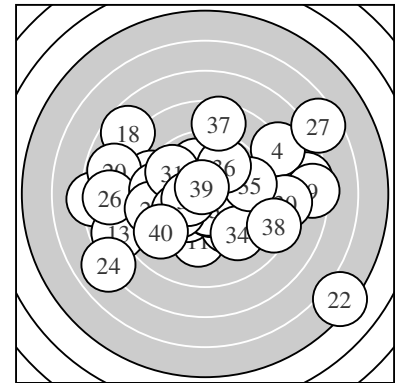

Serie 1:
 7.6 → 8.7 ← 7.8 ← 8.1 ↗ 10.0 ↘
 10.3 * 10.4 * 8.4 ← 7.4 → 10.2 *
 beste Teiler 146.2 (7.) 175.0 (6.) 182.0 (10.)
 Trefferlage 0.60 mm rechts, 0.32 mm hoch
 Streuwert 4.38, horizontal: 6.01, vertikal: 1.49

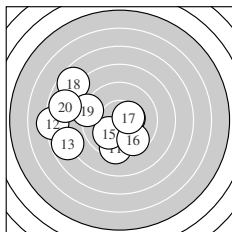

Serie 2:
 9.4 ↓ 7.2 ← 7.8 ↙ 10.4 * 10.0 ↘
 9.7 ↘ 10.4 * 7.7 ↘ 9.1 ← 7.8 ←
 beste Teiler 126.5 (17.) 132.1 (14.) 229.9 (15.)
 Trefferlage 3.26 mm links, 0.29 mm tief
 Streuwert 3.54, horizontal: 4.21, vertikal: 2.71

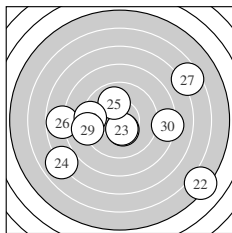

Serie 3:
 10.4 * 5.3 ↘ 10.4 * 7.0 ↙ 10.0 ↖
 7.8 ← 6.6 ↗ 9.3 ← 9.1 ← 8.3 →
 beste Teiler 126.8 (23.) 141.3 (21.) 247.9 (25.)
 Trefferlage 0.28 mm rechts, 1.10 mm tief
 Streuwert 5.61, horizontal: 6.86, vertikal: 3.98

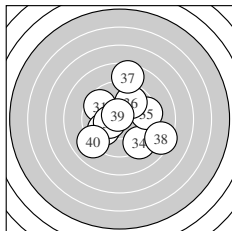

Serie 4:
 9.6 ↘ 9.9 ↙ 10.4 * 9.3 ↘ 9.4 →
 9.8 ↗ 8.6 ↑ 8.4 ↘ 10.7 * 9.0 ↙
 beste Teiler 62.1 (39.) 145.2 (33.) 262.6 (32.)
 Trefferlage 0.45 mm rechts, 0.05 mm hoch
 Streuwert 2.95, horizontal: 3.05, vertikal: 2.86

Unterschrift des Schützen

Meyton Elektronik

Ergebnis:	377	(395.0)
Serien:	94 94 95 94	
Zähler:	21 15 4 0 0 0 0 0 0 0	
Innenzehner:	17	
weiteste:	620 (19), 619 (4), 581 (2)	
beste Teiler	88.5 (26.) 113.3 (23.) 115.1 (33.)	
Trefferlage	0.25 mm links, 0.21 mm hoch	
Streuwert	2.17, horizontal: 2.64, vertikal: 1.56	

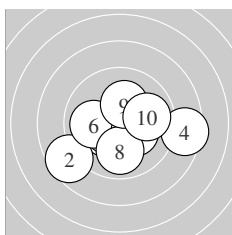
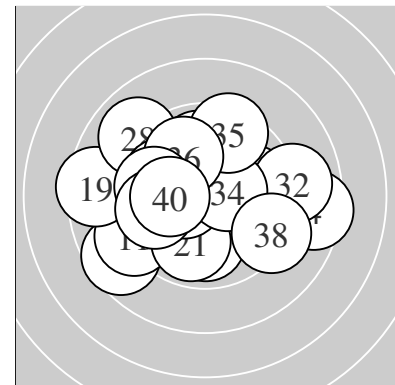

Serie 1:	10.3 *	8.6 ↙	10.5 *	8.5 →	10.4 *
	10.0 ←	10.3 *	9.9 ↓	10.2 *	9.9 →
beste Teiler	116.4 (3.)	126.1 (5.)	155.6 (1.)		
Trefferlage	0.21 mm rechts, 0.75 mm tief				
Streuwert	2.32, horizontal: 2.95, vertikal: 1.44				

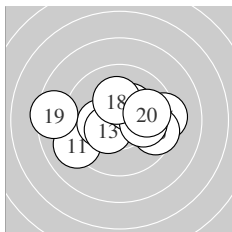

Serie 2:	9.1 ↙	10.2 *	10.4 *	10.3 *	9.3 →
	9.5 →	10.1 →	10.2 *	8.5 ←	9.9 →
beste Teiler	139.9 (13.)	156.4 (14.)	180.1 (12.)		
Trefferlage	0.00 mm , 0.01 mm tief				
Streuwert	2.50, horizontal: 3.33, vertikal: 1.20				

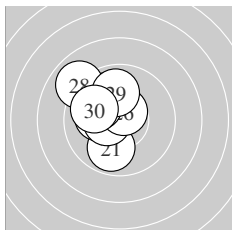

Serie 3:	9.9 ↓	10.2 *	10.5 *	10.5 *	10.0 ↘
	10.6 *	10.0 ↘	8.9 ↘	9.9 ↑	9.9 ↘
beste Teiler	88.5 (26.)	113.3 (23.)	119.0 (24.)		
Trefferlage	1.30 mm links, 1.00 mm hoch				
Streuwert	1.46, horizontal: 1.26, vertikal: 1.64				

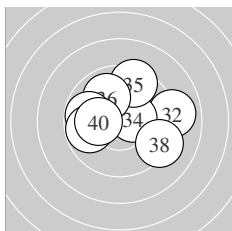

Serie 4:	10.3 *	9.0 →	10.5 *	10.4 *	9.4 ↗
	9.9 ↘	9.8 ←	9.2 ↘	9.8 ←	10.2 *
beste Teiler	115.1 (33.)	129.6 (34.)	154.3 (31.)		
Trefferlage	0.09 mm rechts, 0.62 mm hoch				
Streuwert	2.19, horizontal: 2.69, vertikal: 1.54				

Unterschrift des Schützen

Ergebnis:	342	(359.1)			
Serien:	80	93	84	85	
Zähler:	10	16	7	3	2 1 1 0 0 0
Innenzehner:	9				
weiteste:	1718 (9), 1258 (5), 1228 (22)				
beste Teiler	69.0 (18.) 81.4 (13.) 96.5 (21.)				
Trefferlage	1.93 mm links, 0.13 mm tief				
Streuwert	4.14, horizontal: 5.41, vertikal: 2.22				

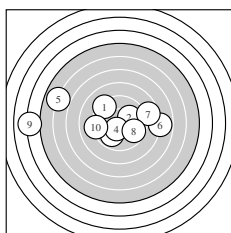
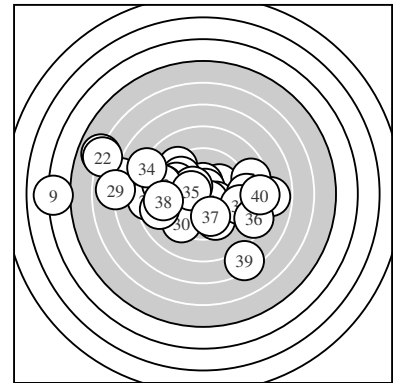

Serie 1:

9.2 ↘	10.1 ↗	9.9 ↙	10.4 *	5.9 ↖
7.9 →	8.6 →	9.7 ↘	4.1 ←	9.1 ←
beste Teiler	126.5 (4.) 219.2 (2.) 265.4 (3.)			
Trefferlage	2.05 mm links, 0.47 mm hoch			
Streuwert	5.60, horizontal: 7.62, vertikal: 2.17			

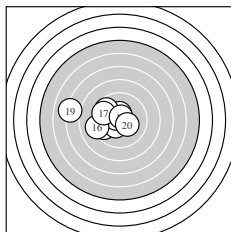

Serie 2:

9.6 ←	10.4 *	10.6 *	10.4 *	9.7 ↖
9.2 ←	9.6 ↖	10.7 *	7.1 ←	10.3 *
beste Teiler	69.0 (18.) 81.4 (13.) 131.0 (14.)			
Trefferlage	2.21 mm links, 0.27 mm hoch			
Streuwert	2.40, horizontal: 3.11, vertikal: 1.36			

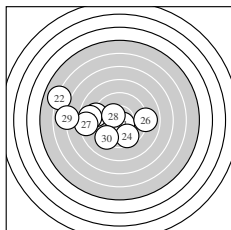

Serie 3:

10.6 *	6.0 ↖	9.1 ←	9.6 ↘	8.7 ←
9.0 →	8.4 ←	10.4 *	6.9 ←	9.3 ↙
beste Teiler	96.5 (21.) 148.0 (28.) 334.1 (24.)			
Trefferlage	3.48 mm links, 0.05 mm tief			
Streuwert	3.96, horizontal: 5.17, vertikal: 2.15			

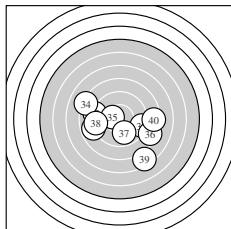

Serie 4:

8.8 ←	9.2 →	9.0 ←	8.1 ↖	10.4 *
8.4 →	9.9 ↘	9.1 ←	7.4 ↘	8.3 →
beste Teiler	139.9 (35.) 271.0 (37.) 440.8 (32.)			
Trefferlage	0.01 mm rechts, 1.24 mm tief			
Streuwert	4.10, horizontal: 5.05, vertikal: 2.85			

Unterschrift des Schützen

Meyton Elektronik

Ergebnis:	373	(391.2)
Serien:	94 92 96 91	
Zähler:	17 20 2 1 0 0 0 0 0 0	
Innenzehner:	14	
weiteste:	767 (37), 707 (18), 579 (39)	
beste Teiler	61.9 (28.) 97.5 (22.) 106.2 (31.)	
Trefferlage	0.25 mm links, 0.46 mm hoch	
Streuwert	2.36, horizontal: 2.53, vertikal: 2.18	

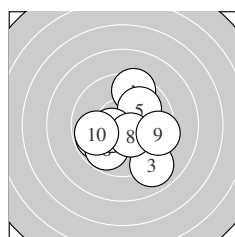
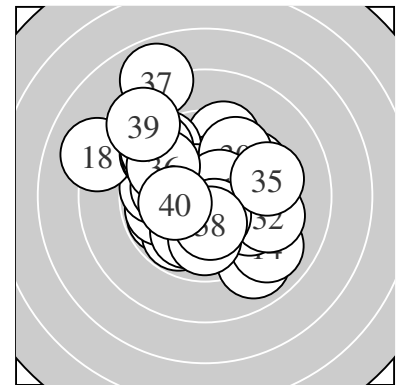

Serie 1:	9.5 ↗	10.3 *	9.0 ↘	9.8 ↙	10.0 ↗
	9.8 ↘	10.5 *	10.4 *	9.5 →	9.8 ↙
beste Teiler	123.4 (7.) 129.9 (8.) 154.9 (2.)				
Trefferlage	0.38 mm rechts, 0.53 mm tief				
Streuwert	2.15, horizontal: 2.24, vertikal: 2.06				

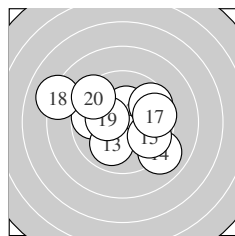

Serie 2:	9.7 ↖	10.4 *	10.0 ↘	9.0 ↘	9.7 ↘
	9.6 ↗	9.6 →	8.1 ↖	10.3 *	9.4 ↘
beste Teiler	148.4 (12.) 161.0 (19.) 245.0 (13.)				
Trefferlage	0.22 mm links, 0.32 mm hoch				
Streuwert	2.79, horizontal: 3.43, vertikal: 1.94				

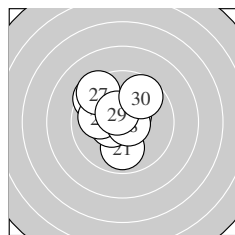

Serie 3:	9.9 ↓	10.6 *	9.5 ↘	10.4 *	10.5 *
	10.0 ↖	9.4 ↘	10.7 *	10.5 *	9.7 ↗
beste Teiler	61.9 (28.) 97.5 (22.) 107.7 (29.)				
Trefferlage	0.73 mm links, 0.76 mm hoch				
Streuwert	1.60, horizontal: 1.54, vertikal: 1.65				

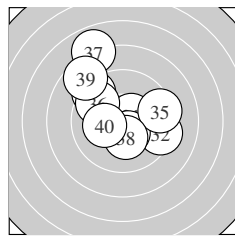

Serie 4:	10.5 *	9.3 →	10.4 *	9.3 ↘	9.4 →
	9.7 ↘	7.9 ↘	10.3 *	8.6 ↘	10.2 *
beste Teiler	106.2 (31.) 132.8 (33.) 170.0 (38.)				
Trefferlage	0.46 mm links, 1.32 mm hoch				
Streuwert	2.80, horizontal: 2.80, vertikal: 2.80				

Unterschrift des Schützen

Meyton Elektronik

Ergebnis:	343	(361.0)
Serien:	81	89 86 87
Zähler:	9	15 9 5 1 1 0 0 0 0
Innenzehner:	7	
weiteste:	1458 (7), 1187 (20), 930 (13)	
beste Teiler	108.4 (28.)	119.5 (16.) 128.8 (19.)
Trefferlage	0.11 mm links, 0.10 mm hoch	
Streuwert	4.04, horizontal: 5.03, vertikal: 2.71	

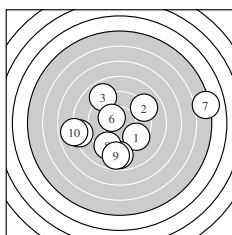
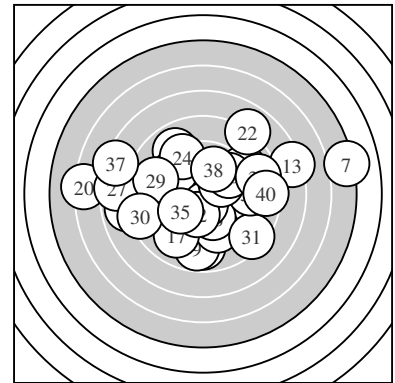

Serie 1:	9.5 ↘	9.0 ↗	8.9 ↖	8.2 ←	8.8 ↓
	10.3 *	5.1 →	9.3 ↙	8.8 ↓	7.9 ←
beste Teiler	157.5 (6.) 355.3 (1.) 421.0 (8.)				
Trefferlage	0.01 mm rechts, 0.90 mm tief				
Streuwert	5.00, horizontal: 6.17, vertikal: 3.45				

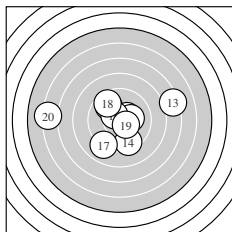

Serie 2:	9.8 ↖	10.4 *	7.2 →	9.4 ↓	10.2 *
	10.5 *	9.0 ↙	9.6 ↖	10.4 *	6.2 ←
beste Teiler	119.5 (16.) 128.8 (19.) 139.1 (12.)				
Trefferlage	0.48 mm links, 0.20 mm hoch				
Streuwert	4.03, horizontal: 5.16, vertikal: 2.42				

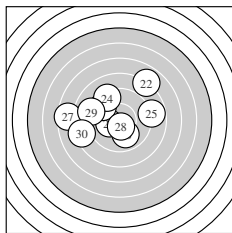

Serie 3:	10.2 *	7.9 ↗	9.5 ↖	9.3 ↖	8.8 →
	9.9 ↓	7.5 ←	10.5 *	9.0 ←	8.3 ←
beste Teiler	108.4 (28.) 179.3 (21.) 253.6 (26.)				
Trefferlage	1.51 mm links, 0.89 mm hoch				
Streuwert	3.65, horizontal: 4.42, vertikal: 2.66				

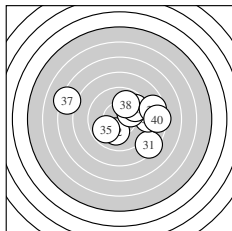

Serie 4:	8.4 ↘	10.1 ↓	9.1 →	10.1 →	9.8 ↙
	9.7 ↗	7.3 ←	9.9 ↗	8.7 →	8.5 →
beste Teiler	204.8 (34.) 213.3 (32.) 267.4 (38.)				
Trefferlage	1.51 mm rechts, 0.22 mm hoch				
Streuwert	3.58, horizontal: 4.51, vertikal: 2.29				

Unterschrift des Schützen

Meyton Elektronik

Ergebnis:	372	(387.7)
Serien:	93 93 91 95	
Zähler:	20 14 4 2 0 0 0 0 0 0	
Innenzehner:	15	
weiteste:	772 (8), 758 (26), 726 (18)	
beste Teiler	14.1 (21.) 36.4 (10.) 57.7 (23.)	
Trefferlage	1.16 mm links, 0.14 mm hoch	
Streuwert	2.56, horizontal: 2.97, vertikal: 2.07	

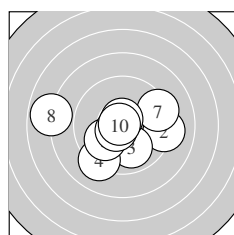
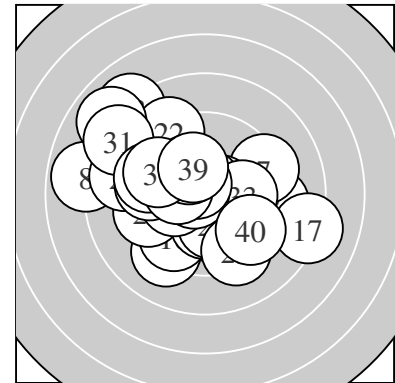

Serie 1:	9.7 ↙	9.2 →	10.0 ↓	9.2 ↘	10.0 ↖
	10.6 *	9.3 →	7.9 ←	10.7 *	10.8 *
beste Teiler	36.4 (10.)	64.4 (9.)	89.0 (6.)		
Trefferlage	0.58 mm links, 0.76 mm tief				
Streuwert	2.68, horizontal: 3.39, vertikal: 1.71				

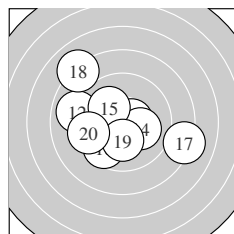

Serie 2:	10.2 *	9.0 ←	10.6 *	10.1 →	10.1 ↖
	9.6 ↘	8.2 →	8.0 ↘	10.2 *	9.4 ←
beste Teiler	99.2 (13.)	192.2 (11.)	194.0 (19.)		
Trefferlage	0.91 mm links, 0.00 mm				
Streuwert	2.99, horizontal: 3.48, vertikal: 2.40				

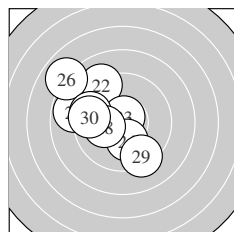

Serie 3:	10.9 *	9.1 ↖	10.7 *	10.2 *	8.8 ←
	7.9 ↘	9.5 ←	10.2 *	9.3 ↓	9.5 ←
beste Teiler	14.1 (21.)	57.7 (23.)	198.6 (24.)		
Trefferlage	1.99 mm links, 0.57 mm hoch				
Streuwert	2.53, horizontal: 2.61, vertikal: 2.45				

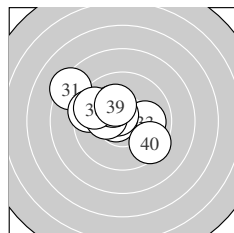

Serie 4:	8.3 ↘	9.5 ←	10.0 →	10.7 *	10.6 *
	10.2 *	10.2 *	9.6 ↘	10.2 *	9.5 ↘
beste Teiler	70.0 (34.)	84.5 (35.)	176.7 (36.)		
Trefferlage	1.16 mm links, 0.77 mm hoch				
Streuwert	2.10, horizontal: 2.57, vertikal: 1.50				

Unterschrift des Schützen

Ergebnis: **370** (392.1)
 Serien: 93 95 90 92
 Zähler: 14 22 4 0 0 0 0 0 0 0
 Innenzehner: 9
 weiteste: 654 (19), 587 (28), 543 (9)
 beste Teiler 29.8 (13.) 41.0 (11.) 44.0 (2.)
 Trefferlage 0.09 mm rechts, 0.02 mm hoch
 Streuwert 2.27, horizontal: 2.48, vertikal: 2.04

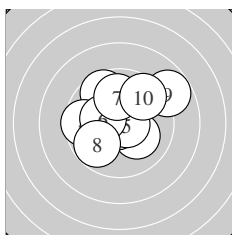
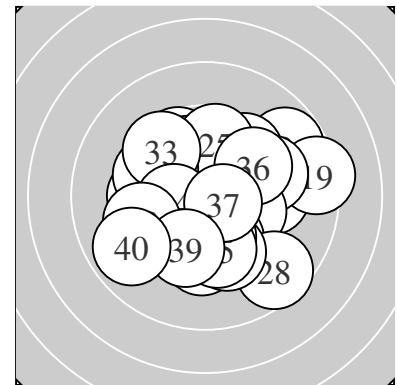

Serie 1:
 10.1 ↘ 10.8 * 9.6 ↖ 9.6 ← 10.7 *
 10.3 * 9.9 ↑ 9.8 ↙ 8.8 ↗ 9.6 ↗
 beste Teiler 44.0 (2.) 68.8 (5.) 166.2 (6.)
 Trefferlage 0.00 mm , 0.76 mm hoch
 Streuwert 2.12, horizontal: 2.39, vertikal: 1.81

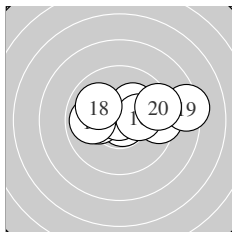

Serie 2:
 10.8 * 10.1 ← 10.8 * 10.2 * 9.4 →
 10.2 * 9.9 ← 10.0 ↘ 8.3 → 9.4 →
 beste Teiler 29.8 (13.) 41.0 (11.) 185.3 (14.)
 Trefferlage 1.06 mm rechts, 0.53 mm hoch
 Streuwert 2.14, horizontal: 2.95, vertikal: 0.67

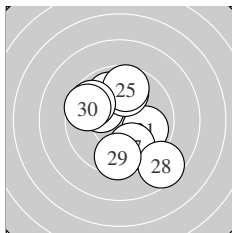

Serie 3:
 9.9 ↘ 9.9 ↖ 10.1 ↘ 9.9 ↑ 9.7 ↑
 9.7 ↘ 9.8 ↘ 8.6 ↘ 9.5 ↓ 9.6 ↖
 beste Teiler 208.3 (23.) 257.5 (22.) 261.2 (21.)
 Trefferlage 0.00 mm , 0.07 mm hoch
 Streuwert 2.47, horizontal: 2.23, vertikal: 2.69

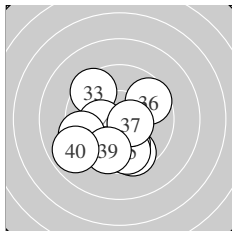

Serie 4:
 9.6 ↓ 10.0 ↓ 9.5 ↘ 10.2 * 9.7 ↓
 9.6 ↗ 10.5 * 9.4 ← 9.7 ↓ 8.9 ↙
 beste Teiler 111.7 (37.) 184.3 (34.) 247.4 (32.)
 Trefferlage 0.68 mm links, 1.25 mm tief
 Streuwert 2.23, horizontal: 2.34, vertikal: 2.11

Unterschrift des Schützen

Ergebnis:	377	(396.1)
Serien:	96 96 95 90	
Zähler:	20 17 3 0 0 0 0 0 0 0	
Innenzehner:	12	
weiteste:	546 (32), 513 (16), 513 (39)	
beste Teiler	57.3 (30.) 73.5 (8.) 73.8 (27.)	
Trefferlage	0.05 mm rechts, 0.60 mm hoch	
Streuwert	2.07, horizontal: 2.13, vertikal: 2.01	

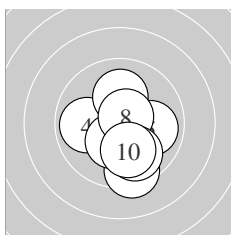
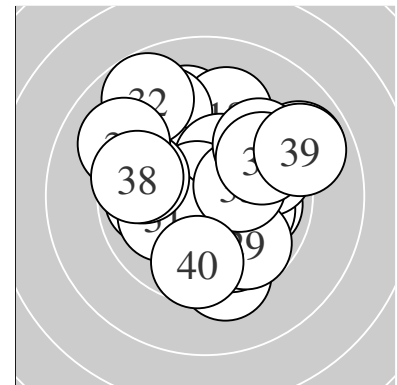

Serie 1:				
	10.6 *	10.4 *	9.4 ↓	9.9 ←
	10.3 *	10.1 ↑	10.7 *	9.9 ↓
beste Teiler	73.5 (8.)	96.5 (1.)	128.8 (2.)	9.9 →
Trefferlage	0.26 mm rechts, 0.95 mm tief			
Streuwert	1.52, horizontal: 1.37, vertikal: 1.66			

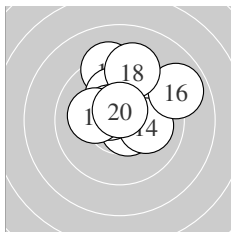

Serie 2:				
	10.5 *	9.3 ↑	10.6 *	10.1 →
	8.9 ↗	10.5 *	9.3 ↑	10.1 ←
beste Teiler	82.0 (20.)	93.3 (13.)	101.2 (17.)	10.6 *
Trefferlage	0.47 mm rechts, 1.41 mm hoch			
Streuwert	1.76, horizontal: 1.84, vertikal: 1.68			

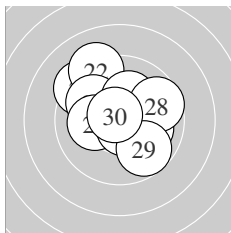

Serie 3:				
	9.3 ↘	9.2 ↘	9.9 ↘	10.1 ←
	10.2 *	10.7 *	9.7 ↗	9.7 ↓
beste Teiler	57.3 (30.)	73.8 (27.)	190.0 (26.)	10.1 →
Trefferlage	0.13 mm links, 0.76 mm hoch			
Streuwert	1.97, horizontal: 2.11, vertikal: 1.83			

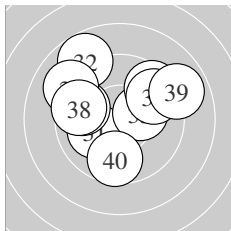

Serie 4:				
	10.1 ←	8.8 ↘	10.3 *	9.7 ←
	9.5 ↗	9.6 ↗	9.6 ←	9.1 ↘
beste Teiler	175.2 (33.)	222.3 (31.)	315.4 (34.)	9.7 ↓
Trefferlage	0.37 mm links, 1.19 mm hoch			
Streuwert	2.65, horizontal: 3.07, vertikal: 2.16			

Unterschrift des Schützen

Meyton Elektronik

Ergebnis: **377** (397.7)
 Serien: 93 94 97 93
 Zähler: 19 19 2 0 0 0 0 0 0 0
 Innenzehner: 12
 weiteste: 529 (6), 518 (36), 469 (20)
 beste Teiler 19.6 (24.) 50.6 (26.) 54.4 (17.)
 Trefferlage 0.12 mm links, 0.00 mm
 Streuwert 1.99, horizontal: 2.32, vertikal: 1.60

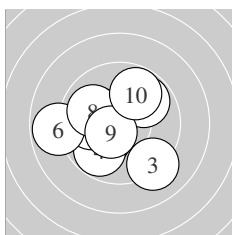
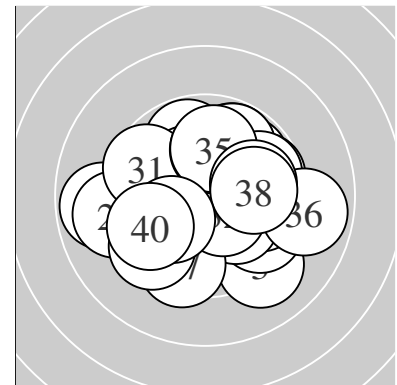

Serie 1:
 10.2 * 9.8 ↗ 9.1 ↘ 9.8 ✓ 10.0 ←
 8.8 ← 10.2 * 9.9 ↖ 10.5 * 9.8 ↗
 beste Teiler 106.7 (9.) 179.1 (1.) 185.7 (7.)
 Trefferlage 0.90 mm links, 0.22 mm tief
 Streuwert 2.17, horizontal: 2.43, vertikal: 1.87

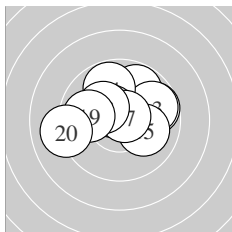

Serie 2:
 9.7 → 9.8 ↗ 9.8 → 9.8 ↑ 10.1 →
 10.5 * 10.7 * 10.2 * 9.9 ← 9.1 ←
 beste Teiler 54.4 (17.) 106.8 (16.) 178.2 (18.)
 Trefferlage 0.06 mm links, 0.81 mm hoch
 Streuwert 1.94, horizontal: 2.45, vertikal: 1.21

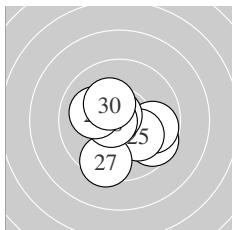

Serie 3:
 9.6 ↘ 10.3 * 9.8 → 10.9 * 10.1 ↘
 10.8 * 9.5 ↓ 10.7 * 10.1 ↖ 10.3 *
 beste Teiler 19.6 (24.) 50.6 (26.) 72.6 (28.)
 Trefferlage 0.30 mm rechts, 0.59 mm tief
 Streuwert 1.56, horizontal: 1.71, vertikal: 1.39

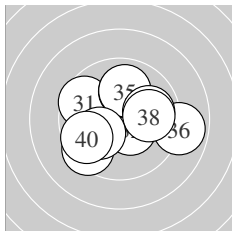

Serie 4:
 9.6 ↖ 10.4 * 9.4 ✓ 10.0 ↑ 10.0 ↑
 8.9 → 9.9 → 9.9 → 10.1 ✓ 9.7 ←
 beste Teiler 127.3 (32.) 211.6 (39.) 241.8 (34.)
 Trefferlage 0.16 mm rechts, 0.00 mm
 Streuwert 2.28, horizontal: 2.74, vertikal: 1.71

Unterschrift des Schützen

Ergebnis: **385** (402.2)
 Serien: 97 94 99 95
 Zähler: 25 15 0 0 0 0 0 0 0 0
 Innenzehner: 15
 weiteste: 496 (21), 433 (36), 415 (11)
 beste Teiler 36.0 (7.) 47.3 (3.) 60.1 (5.)
 Trefferlage 0.16 mm rechts, 0.00 mm
 Streuwert 1.77, horizontal: 1.86, vertikal: 1.69

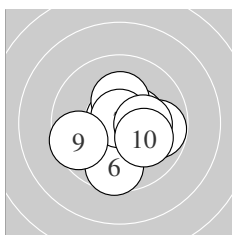
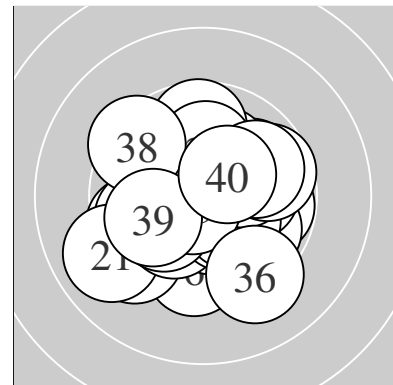

Serie 1:
 10.4 * 9.8 → 10.8 * 10.3 * 10.7 *
 9.6 ↓ 10.8 * 10.2 * 9.6 ← 10.1 ↘
 beste Teiler 36.0 (7.) 47.3 (3.) 60.1 (5.)
 Trefferlage 0.43 mm rechts, 0.38 mm tief
 Streuwert 1.51, horizontal: 1.67, vertikal: 1.34

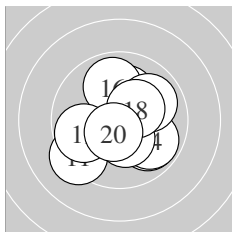

Serie 2:
 9.3 ↙ 10.1 ↑ 9.9 ↘ 9.9 ↘ 10.4 *
 9.9 ↑ 9.9 ↗ 10.4 * 9.8 ← 10.5 *
 beste Teiler 103.3 (20.) 145.4 (15.) 150.6 (18.)
 Trefferlage 0.19 mm rechts, 0.24 mm tief
 Streuwert 1.87, horizontal: 1.95, vertikal: 1.78

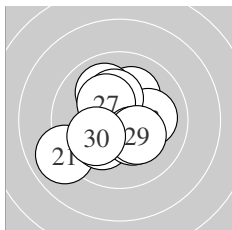

Serie 3:
 9.0 ↙ 10.1 ↗ 10.1 → 10.0 ↖ 10.3 *
 10.1 ↙ 10.3 * 10.3 * 10.3 * 10.1 ↙
 beste Teiler 156.3 (28.) 165.8 (27.) 172.2 (25.)
 Trefferlage 0.45 mm links, 0.06 mm tief
 Streuwert 1.79, horizontal: 1.87, vertikal: 1.70

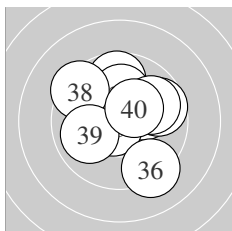

Serie 4:
 10.1 → 9.7 ↑ 10.7 * 9.7 → 10.1 ↑
 9.2 ↘ 9.9 ↗ 9.4 ↖ 10.0 ← 10.4 *
 beste Teiler 65.1 (33.) 149.4 (40.) 203.0 (31.)
 Trefferlage 0.48 mm rechts, 0.66 mm hoch
 Streuwert 2.00, horizontal: 2.05, vertikal: 1.95

Unterschrift des Schützen

Meyton Elektronik

Ergebnis:	366	(386.1)
Serien:	90 92 93 91	
Zähler:	15 16 9 0 0 0 0 0 0	
Innenzehner:	13	
weiteste:	624 (7), 615 (20), 594 (26)	
beste Teiler	37.1 (8.) 41.3 (15.) 123.0 (28.)	
Trefferlage	0.50 mm rechts, 0.91 mm hoch	
Streuwert	2.52, horizontal: 2.76, vertikal: 2.27	

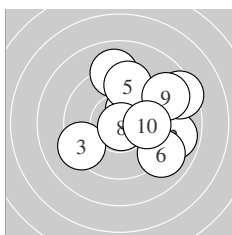
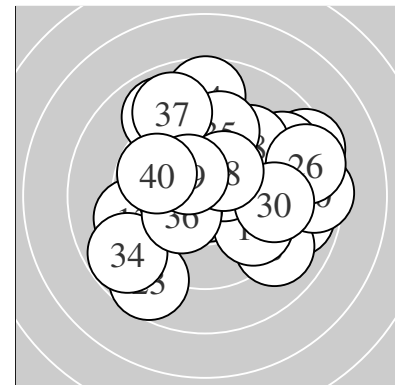

Serie 1:	10.3 *	8.9 →	9.3 ↙	9.1 ↑	9.5 ↑
	9.0 ↘	8.5 →	10.8 *	9.0 →	9.9 →
beste Teiler	37.1 (8.)	160.0 (1.)	257.4 (10.)		
Trefferlage	1.92 mm rechts, 0.81 mm hoch				
Streuwert	2.72, horizontal: 2.90, vertikal: 2.53				

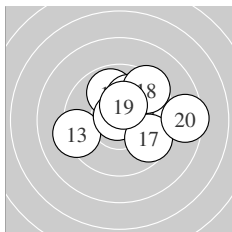

Serie 2:	9.9 ↑	9.8 →	9.3 ↙	9.9 →	10.8 *
	10.1 ↑	9.7 ↘	9.4 ↗	10.4 *	8.5 →
beste Teiler	41.3 (15.)	144.5 (19.)	224.2 (16.)		
Trefferlage	1.27 mm rechts, 0.64 mm hoch				
Streuwert	2.22, horizontal: 2.73, vertikal: 1.56				

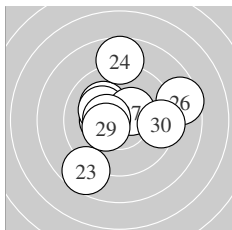

Serie 3:	10.3 *	10.1 ↘	8.7 ↙	8.7 ↑	10.2 *
	8.6 →	10.4 *	10.5 *	10.4 *	9.4 →
beste Teiler	123.0 (28.)	134.8 (27.)	144.0 (29.)		
Trefferlage	0.03 mm rechts, 0.49 mm hoch				
Streuwert	2.67, horizontal: 2.77, vertikal: 2.56				

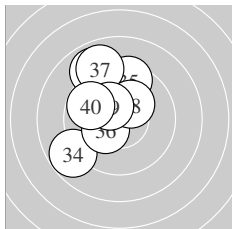

Serie 4:	8.9 ↘	10.2 *	9.7 ↘	8.8 ↙	9.5 ↑
	10.3 *	8.9 ↘	10.3 *	10.3 *	9.8 ↘
beste Teiler	152.6 (39.)	165.0 (36.)	175.0 (38.)		
Trefferlage	1.21 mm links, 1.71 mm hoch				
Streuwert	2.12, horizontal: 1.74, vertikal: 2.44				

Unterschrift des Schützen

Meyton Elektronik

Ergebnis: **378** (397.6)
 Serien: 95 93 93 97
 Zähler: 21 16 3 0 0 0 0 0 0 0
 Innenzehner: 14
 weiteste: 642 (22), 598 (16), 508 (24)
 beste Teiler 31.7 (26.) 43.4 (15.) 61.6 (35.)
 Trefferlage 0.53 mm rechts, 0.64 mm hoch
 Streuwert 1.98, horizontal: 2.24, vertikal: 1.70

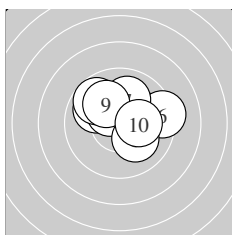
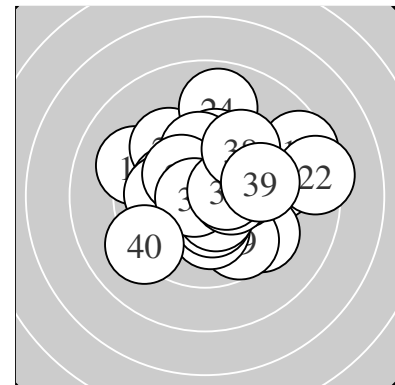

Serie 1:
 9.9 ↘ 9.9 ↘ 10.4 * 9.9 → 9.7 ↘
 9.3 → 10.0 ↑ 10.1 ↘ 10.1 ↘ 10.2 *
 beste Teiler 135.8 (3.) 182.0 (10.) 208.6 (8.)
 Trefferlage 0.24 mm rechts, 1.03 mm hoch
 Streuwert 1.76, horizontal: 2.21, vertikal: 1.13

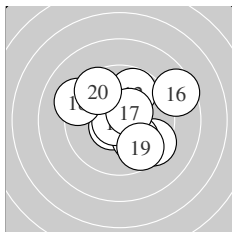

Serie 2:
 10.6 * 9.8 ↑ 9.4 ↘ 10.0 ↘ 10.8 *
 8.6 → 10.5 * 9.2 ↘ 9.7 ↘ 9.6 ↘
 beste Teiler 43.4 (15.) 91.5 (11.) 121.3 (17.)
 Trefferlage 0.70 mm rechts, 0.34 mm hoch
 Streuwert 2.38, horizontal: 2.66, vertikal: 2.07

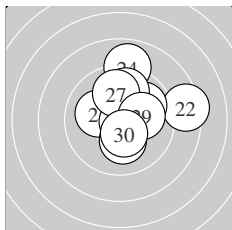

Serie 3:
 10.1 ↖ 8.4 → 9.9 ↗ 8.9 ↑ 9.8 ↑
 10.8 * 9.9 ↑ 10.2 * 10.1 → 10.4 *
 beste Teiler 31.7 (26.) 133.7 (30.) 196.4 (28.)
 Trefferlage 1.06 mm rechts, 1.05 mm hoch
 Streuwert 2.12, horizontal: 2.19, vertikal: 2.04

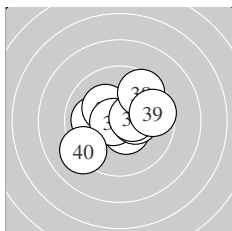

Serie 4:
 10.7 * 10.5 * 10.0 ← 10.2 * 10.7 *
 10.4 * 10.4 * 9.6 ↗ 9.7 → 9.2 ↙
 beste Teiler 61.6 (35.) 64.2 (31.) 110.9 (32.)
 Trefferlage 0.13 mm rechts, 0.12 mm hoch
 Streuwert 1.77, horizontal: 2.07, vertikal: 1.41

Unterschrift des Schützen

Meyton Elektronik

Ergebnis: **352** (372.6)
 Serien: 87 91 87 87
 Zähler: 8 17 14 1 0 0 0 0 0 0
 Innenzehner: 6
 weiteste: 944 (38), 713 (15), 705 (27)
 beste Teiler 23.4 (20.) 62.2 (32.) 72.2 (10.)
 Trefferlage 1.17 mm rechts, 0.13 mm hoch
 Streuwert 3.16, horizontal: 2.88, vertikal: 3.43

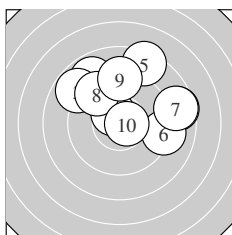
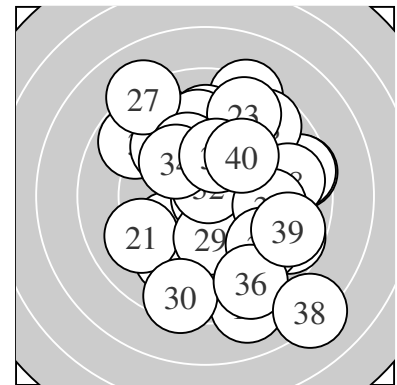

Serie 1:
 10.5 * 8.8 ↘ 8.8 ↘ 8.6 → 8.3 ↗
 9.1 → 8.6 → 9.5 ↘ 9.2 ↑ 10.7 *
 beste Teiler 72.2 (10.) 117.3 (1.) 375.8 (8.)
 Trefferlage 0.92 mm rechts, 2.41 mm hoch
 Streuwert 2.98, horizontal: 3.58, vertikal: 2.21

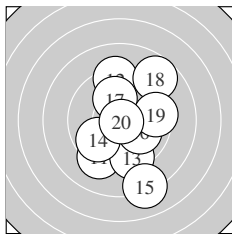

Serie 2:
 9.3 ↙ 9.3 ↑ 9.4 ↓ 9.8 ↙ 8.1 ↓
 10.0 ↘ 10.1 ↑ 8.7 ↗ 9.5 → 10.9 *
 beste Teiler 23.4 (20.) 222.0 (17.) 235.1 (16.)
 Trefferlage 0.81 mm rechts, 0.62 mm tief
 Streuwert 2.94, horizontal: 2.15, vertikal: 3.56

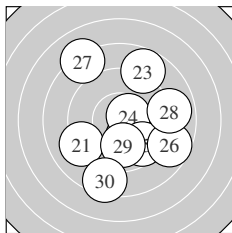

Serie 3:
 9.1 ↙ 10.2 * 8.8 ↗ 10.6 * 9.6 ↘
 8.7 ↘ 8.1 ↘ 8.9 → 9.9 ↓ 8.5 ↓
 beste Teiler 99.2 (24.) 183.3 (22.) 255.1 (29.)
 Trefferlage 0.77 mm rechts, 0.52 mm tief
 Streuwert 3.42, horizontal: 3.14, vertikal: 3.69

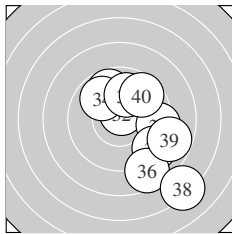

Serie 4:
 9.8 ↘ 10.7 * 9.4 → 9.9 ↘ 9.1 ↘
 8.6 ↓ 9.9 ↑ 7.2 ↘ 8.8 → 9.6 ↗
 beste Teiler 62.2 (32.) 253.2 (37.) 273.1 (34.)
 Trefferlage 2.18 mm rechts, 0.73 mm tief
 Streuwert 3.08, horizontal: 2.65, vertikal: 3.46

Unterschrift des Schützen

Meyton Elektronik

Ergebnis: **370** (386.1)
 Serien: 88 95 93 94
 Zähler: 19 13 7 1 0 0 0 0 0 0
 Innenzehner: 14
 weiteste: 935 (8), 666 (4), 618 (17)
 beste Teiler 69.7 (10.) 72.4 (31.) 81.0 (30.)
 Trefferlage 0.73 mm links, 0.23 mm tief
 Streuwert 2.65, horizontal: 3.11, vertikal: 2.10

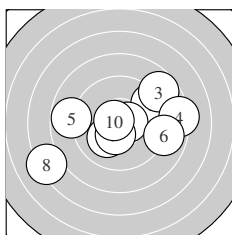
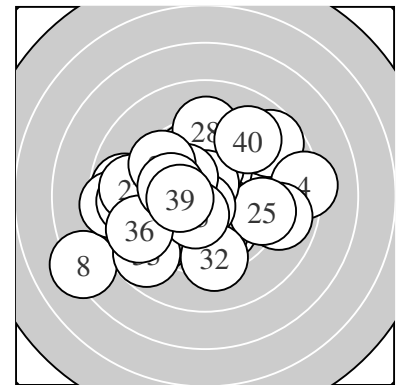

Serie 1:
 9.3 ↗ 10.6 * 8.7 ↗ 8.3 → 8.8 ←
 8.9 → 10.1 ↙ 7.2 ↙ 10.4 * 10.7 *
 beste Teiler 69.7 (10.) 91.5 (2.) 134.4 (9.)
 Trefferlage 0.43 mm rechts, 0.13 mm tief
 Streuwert 3.66, horizontal: 4.67, vertikal: 2.23

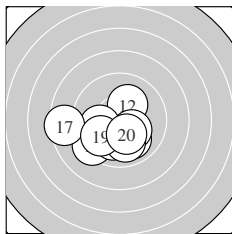

Serie 2:
 9.3 ↙ 10.2 * 10.0 ↘ 10.3 * 10.0 ←
 10.0 ↓ 8.5 ← 9.9 ↓ 9.9 ↙ 10.3 *
 beste Teiler 173.5 (14.) 173.9 (20.) 193.6 (12.)
 Trefferlage 0.93 mm links, 1.33 mm tief
 Streuwert 1.96, horizontal: 2.44, vertikal: 1.31

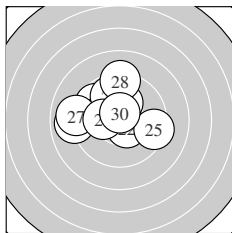

Serie 3:
 9.6 ↖ 10.5 * 8.9 ← 10.2 * 9.4 →
 9.8 ↖ 9.0 ← 9.2 ↑ 10.2 * 10.6 *
 beste Teiler 81.0 (30.) 116.7 (22.) 184.2 (29.)
 Trefferlage 1.03 mm links, 1.00 mm hoch
 Streuwert 2.26, horizontal: 2.70, vertikal: 1.71

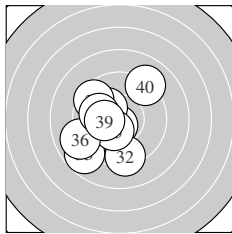

Serie 4:
 10.7 * 9.3 ↓ 8.8 ↙ 10.2 * 10.4 *
 9.0 ← 9.5 ↖ 10.0 ← 10.3 * 9.1 ↗
 beste Teiler 72.4 (31.) 142.2 (35.) 168.7 (39.)
 Trefferlage 1.38 mm links, 0.45 mm tief
 Streuwert 2.35, horizontal: 2.17, vertikal: 2.52

Unterschrift des Schützen

Meyton Elektronik

Ergebnis: **353** (369.9)
 Serien: 93 87 90 83
 Zähler: 10 16 11 3 0 0 0 0 0 0
 Innenzehner: 2
 weiteste: 3061 (38), 2737 (32), 2408 (40)
 beste Teiler 437.0 (31.) 456.4 (21.) 488.0 (8.)
 Trefferlage 0.10 mm rechts, 0.80 mm tief
 Streuwert 10.73, horizontal: 10.12, vertikal: 11.30

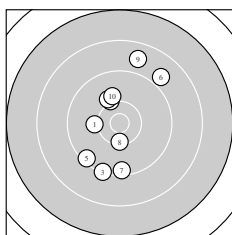
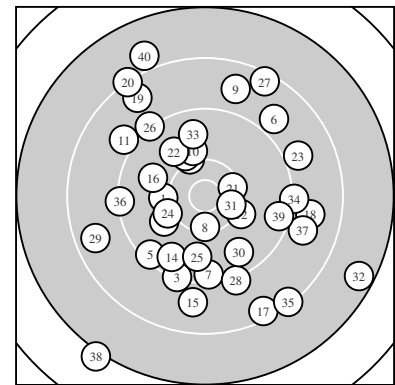

Serie 1:
 10.1 ← 10.2 ↗ 9.3 ↓ 10.1 ↖ 9.4 ↘
 8.9 ↗ 9.4 ↓ 10.3 ↓ 8.8 ↑ 10.0 ↑
 beste Teiler 488.0 (8.) 624.0 (2.) 659.6 (1.)
 Trefferlage 1.07 mm links, 0.85 mm hoch
 Streuwert 8.37, horizontal: 5.65, vertikal: 10.40

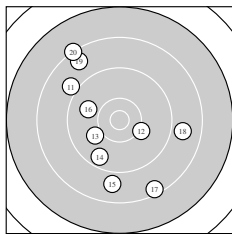

Serie 2:
 9.0 ↖ 10.2 ↘ 10.0 ↙ 9.6 ↓ 8.8 ↓
 9.9 ↖ 8.4 ↓ 8.8 → 8.6 ↖ 8.2 ↖
 beste Teiler 635.9 (12.) 761.6 (13.) 870.3 (16.)
 Trefferlage 2.60 mm links, 0.92 mm tief
 Streuwert 11.22, horizontal: 9.95, vertikal: 12.37

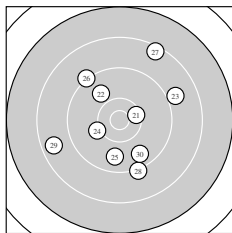

Serie 3:
 10.4 * 9.9 ↖ 9.0 → 10.1 ↙ 9.7 ↓
 9.2 ↖ 8.4 ↑ 9.2 ↓ 8.6 ↙ 9.7 ↓
 beste Teiler 456.4 (21.) 650.9 (24.) 852.0 (22.)
 Trefferlage 0.06 mm rechts, 0.25 mm hoch
 Streuwert 9.85, horizontal: 9.49, vertikal: 10.20

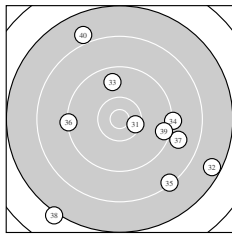

Serie 4:
 10.4 * 7.5 ↘ 9.7 ↑ 9.2 → 8.3 ↓
 9.3 ← 8.9 ↘ 7.1 ↙ 9.4 → 7.9 ↖
 beste Teiler 437.0 (31.) 990.0 (33.) 1209.1 (39.)
 Trefferlage 4.05 mm rechts, 3.41 mm tief
 Streuwert 13.63, horizontal: 13.98, vertikal: 13.28

Unterschrift des Schützen

Meyton Elektronik

Ergebnis: **357** (376.5)
 Serien: 89 85 93 90
 Zähler: 11 18 8 3 0 0 0 0 0 0
 Innenzehner: 4
 weiteste: 3131 (13), 2640 (34), 2430 (10)
 beste Teiler 133.0 (23.) 232.1 (31.) 240.6 (8.)
 Trefferlage 1.30 mm rechts, 1.07 mm hoch
 Streuwert 9.95, horizontal: 10.53, vertikal: 9.34

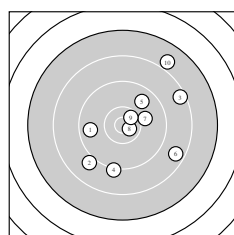
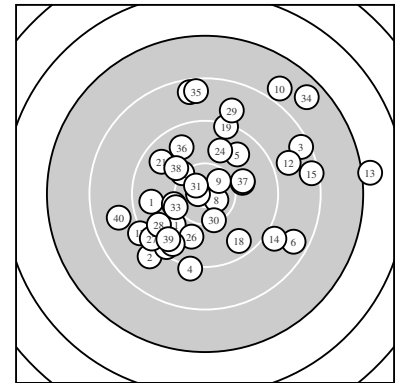

Serie 1:
 9.7 ← 9.0 ↙ 8.4 → 9.2 ↓ 9.8 ↗
 8.6 ↘ 10.0 → 10.7 * 10.5 * 7.9 ↗
 beste Teiler 240.6 (8.) 355.1 (9.) 735.3 (7.)
 Trefferlage 4.32 mm rechts, 0.32 mm hoch
 Streuwert 10.24, horizontal: 10.17, vertikal: 10.30

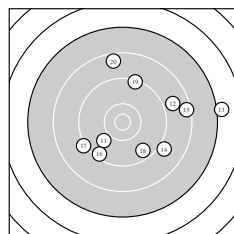

Serie 2:
 9.9 ↗ 8.9 → 7.0 → 9.0 ↘ 8.4 →
 9.4 ↗ 9.2 ↙ 9.6 ↘ 9.3 ↑ 8.5 ↑
 beste Teiler 826.6 (11.) 1090.4 (18.) 1235.7 (16.)
 Trefferlage 6.19 mm rechts, 0.50 mm hoch
 Streuwert 12.09, horizontal: 13.75, vertikal: 10.15

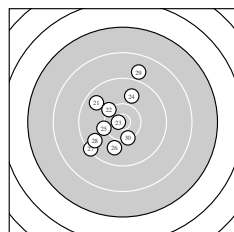

Serie 3:
 9.7 ↘ 10.2 ↘ 10.8 * 9.9 ↑ 10.2 ←
 9.9 ↓ 9.3 ↙ 9.6 ↙ 8.9 ↑ 10.3 ↓
 beste Teiler 133.0 (23.) 522.4 (30.) 579.7 (22.)
 Trefferlage 3.14 mm links, 0.46 mm hoch
 Streuwert 6.67, horizontal: 5.18, vertikal: 7.89

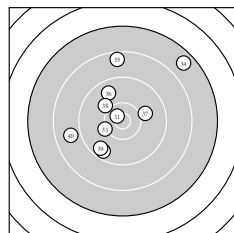

Serie 4:
 10.7 * 9.5 ↙ 10.2 ← 7.7 ↗ 8.5 ↑
 9.7 ↘ 10.0 → 10.0 ↘ 9.6 ↙ 8.8 ←
 beste Teiler 232.1 (31.) 605.9 (33.) 727.3 (38.)
 Trefferlage 2.17 mm links, 3.02 mm hoch
 Streuwert 9.76, horizontal: 9.44, vertikal: 10.06

Unterschrift des Schützen

Meyton Elektronik

Ergebnis: **340** (360.9)
 Serien: 85 84 87 84
 Zähler: 7 16 10 5 1 1 0 0 0 0
 Innenzehner: 1
 weiteste: 4206 (5), 3492 (13), 2757 (25)
 beste Teiler 155.1 (11.) 489.1 (37.) 715.0 (9.)
 Trefferlage 0.95 mm rechts, 1.71 mm tief
 Streuwert 12.54, horizontal: 12.48, vertikal: 12.61

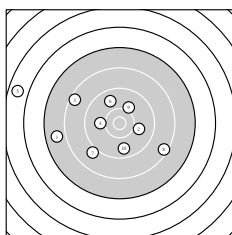
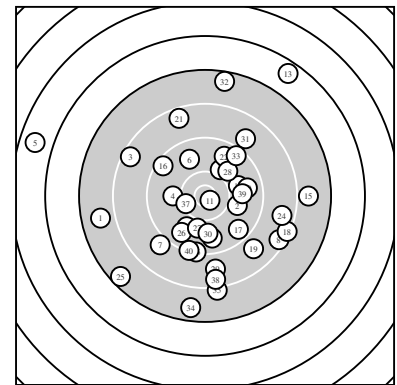

Serie 1:
 7.8 ← 10.0 → 8.5 ↖ 10.0 ← 5.7 ↖
 9.8 ↘ 9.0 ↙ 8.4 ↘ 10.1 ↗ 9.7 ↓

beste Teiler 715.0 (9.) 760.0 (4.) 794.8 (2.)
 Trefferlage 7.39 mm links, 0.26 mm tief
 Streuwert 13.49, horizontal: 16.82, vertikal: 9.00

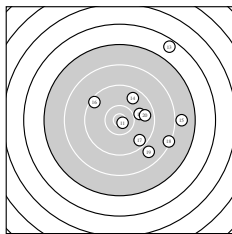

Serie 2:
 10.8 * 9.9 → 6.6 ↗ 9.7 ↗ 7.9 →
 9.4 ↖ 9.6 ↘ 8.3 ↘ 8.8 ↘ 9.7 →

beste Teiler 155.1 (11.) 823.6 (12.) 1010.1 (14.)
 Trefferlage 9.70 mm rechts, 1.92 mm hoch
 Streuwert 10.85, horizontal: 9.98, vertikal: 11.66

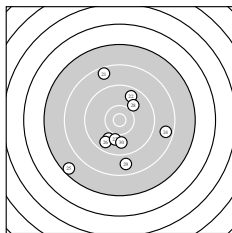

Serie 3:
 8.5 ↖ 9.7 ↗ 9.9 ↙ 8.6 → 7.5 ↖
 9.7 ↙ 10.0 ↓ 10.0 ↗ 8.8 ↓ 9.8 ↓

beste Teiler 780.7 (27.) 793.3 (28.) 846.6 (23.)
 Trefferlage 0.66 mm links, 3.96 mm tief
 Streuwert 10.84, horizontal: 9.83, vertikal: 11.75

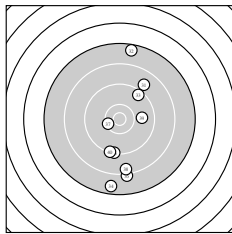

Serie 4:
 8.9 ↗ 7.5 ↑ 9.4 ↗ 7.6 ↓ 8.1 ↓
 9.3 ↓ 10.3 ← 8.5 ↓ 9.8 → 9.3 ↓

beste Teiler 489.1 (37.) 881.5 (39.) 1201.1 (33.)
 Trefferlage 2.18 mm rechts, 4.56 mm tief
 Streuwert 12.87, horizontal: 5.39, vertikal: 17.38

Unterschrift des Schützen

Meyton Elektronik

Ergebnis: **349** (366.6)
 Serien: 86 88 91 84
 Zähler: 9 18 8 3 2 0 0 0 0 0
 Innenzehner: 3
 weiteste: 3480 (31), 3340 (40), 3152 (16)
 beste Teiler 216.4 (11.) 363.0 (32.) 373.8 (25.)
 Trefferlage 0.17 mm links, 3.57 mm tief
 Streuwert 11.36, horizontal: 8.65, vertikal: 13.54

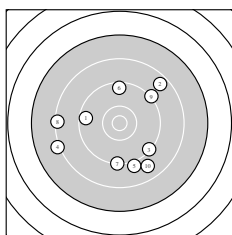
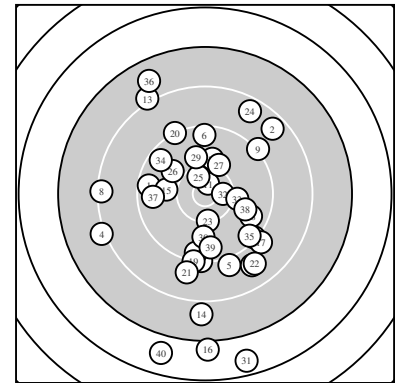

Serie 1:
 9.5 ← 8.6 ↗ 9.3 ↘ 8.1 ← 9.0 ↓
 9.5 ↑ 9.2 ↓ 8.3 ← 9.2 ↗ 8.8 ↘
 beste Teiler 1151.7 (1.) 1194.0 (6.) 1330.4 (3.)
 Trefferlage 0.54 mm links, 2.28 mm tief
 Streuwert 12.05, horizontal: 13.00, vertikal: 11.02

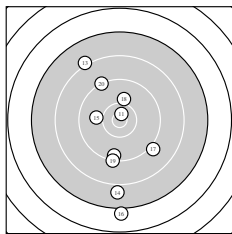

Serie 2:
 10.7 * 9.4 ↓ 8.1 ↖ 7.9 ↓ 10.0 ←
 7.0 ↓ 9.1 ↘ 10.0 ↑ 9.2 ↓ 9.2 ↖
 beste Teiler 216.4 (11.) 726.0 (18.) 788.9 (15.)
 Trefferlage 1.66 mm links, 4.95 mm tief
 Streuwert 12.23, horizontal: 6.22, vertikal: 16.15

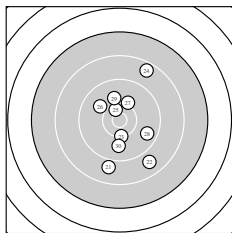

Serie 3:
 8.9 ↓ 8.8 ↘ 10.3 ↓ 8.6 ↗ 10.5 *
 9.9 ↖ 10.1 ↗ 9.7 ↘ 10.0 ↑ 9.9 ↓
 beste Teiler 373.8 (25.) 544.8 (23.) 651.2 (27.)
 Trefferlage 1.80 mm rechts, 1.04 mm tief
 Streuwert 8.42, horizontal: 5.85, vertikal: 10.38

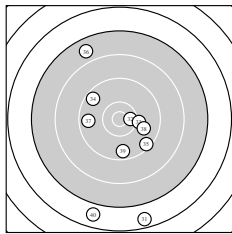

Serie 4:
 6.6 ↓ 10.5 * 10.1 → 9.5 ↖ 9.4 ↘
 7.8 ↖ 9.6 ← 9.9 ↘ 9.6 ↓ 6.8 ↓
 beste Teiler 363.0 (32.) 660.4 (33.) 873.0 (38.)
 Trefferlage 0.29 mm links, 6.02 mm tief
 Streuwert 13.46, horizontal: 8.66, vertikal: 16.94

Unterschrift des Schützen

Meyton Elektronik

Ergebnis: **299** (316.8)
 Serien: 74 78 78 69
 Zähler: 3 6 12 10 5 3 1 0 0 0
 Innenzehner: 1
 weiteste: 5000 (4), 4393 (36), 4124 (40)
 beste Teiler 473.7 (13.) 530.9 (33.) 680.6 (31.)
 Trefferlage 7.61 mm rechts, 4.43 mm hoch
 Streuwert 17.90, horizontal: 15.09, vertikal: 20.33

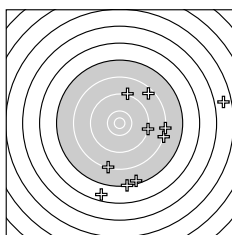
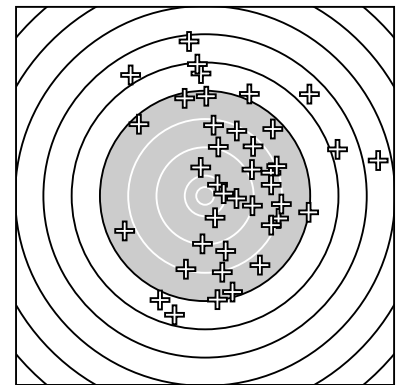

Serie 1:
 7.4 ↘ 8.5 ↗ 9.2 → 4.7 → 7.3 ↓
 8.3 ↓ 6.6 ↓ 8.2 → 9.2 ↑ 8.2 →
 beste Teiler 1369.3 (3.) 1435.8 (9.) 1952.5 (2.)
 Trefferlage 11.93 mm rechts, 8.45 mm tief
 Streuwert 17.35, horizontal: 16.43, vertikal: 18.23

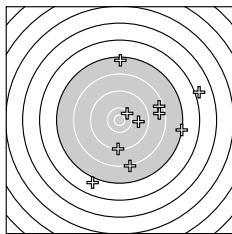

Serie 2:
 8.2 ↓ 6.9 ↓ 10.4 * 9.3 ↓ 8.5 →
 9.8 → 7.4 ↑ 6.0 → 8.6 → 7.2 →
 beste Teiler 473.7 (13.) 892.9 (16.) 1358.9 (14.)
 Trefferlage 10.83 mm rechts, 1.57 mm tief
 Streuwert 16.01, horizontal: 15.15, vertikal: 16.82

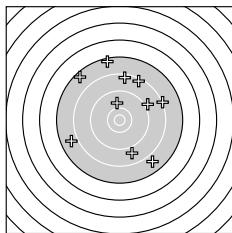

Serie 3:
 9.9 ↑ 7.9 ← 8.9 ↓ 9.0 → 7.4 ↑
 7.5 ↘ 8.2 → 8.4 ↑ 8.4 ↑ 7.8 ↘
 beste Teiler 814.1 (21.) 1522.6 (24.) 1664.7 (23.)
 Trefferlage 1.79 mm rechts, 6.51 mm hoch
 Streuwert 15.32, horizontal: 14.22, vertikal: 16.34

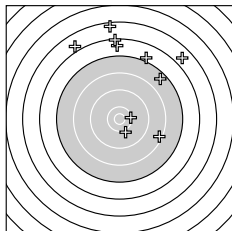

Serie 4:
 10.1 ↘ 6.6 ↑ 10.3 → 6.3 ↑ 5.9 ↘
 5.5 ↑ 7.6 ↗ 8.4 → 7.0 ↑ 5.8 ↗
 beste Teiler 530.9 (33.) 680.6 (31.) 2047.4 (38.)
 Trefferlage 5.91 mm rechts, 21.26 mm hoch
 Streuwert 16.97, horizontal: 14.54, vertikal: 19.08

Unterschrift des Schützen

Ergebnis: **324** (341.5)
 Serien: 83 86 80 75
 Zähler: 5 15 10 4 2 3 1 0 0 0
 Innenzehner: 2
 weiteste: 4840 (23), 4198 (5), 4174 (38)
 beste Teiler 322.5 (11.) 475.5 (29.) 483.8 (17.)
 Trefferlage 0.29 mm rechts, 1.59 mm hoch
 Streuwert 15.93, horizontal: 16.26, vertikal: 15.59

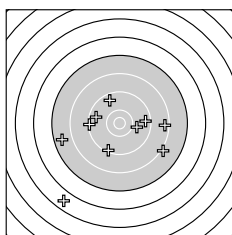
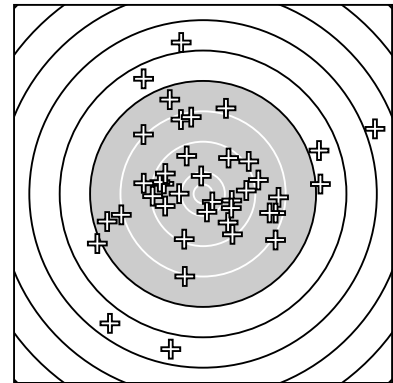

Serie 1:
 8.1 ↘ 9.6 ← 9.6 ↗ 9.5 → 5.7 ↙
 9.3 ← 9.3 ↓ 8.5 → 7.7 ← 10.0 →
 beste Teiler 775.7 (10.) 1065.7 (2.) 1088.9 (3.)
 Trefferlage 2.47 mm links, 5.50 mm tief
 Streuwert 14.46, horizontal: 16.50, vertikal: 12.07

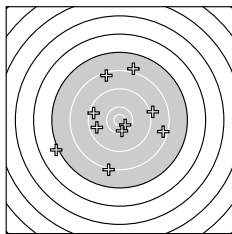

Serie 2:
 10.5 * 9.5 ← 8.2 ↓ 7.1 ← 9.1 →
 8.5 → 10.3 ↓ 8.0 ↑ 8.4 ↗ 9.6 ←
 beste Teiler 322.5 (11.) 483.8 (17.) 1047.7 (20.)
 Trefferlage 1.66 mm links, 0.09 mm tief
 Streuwert 13.49, horizontal: 13.56, vertikal: 13.41

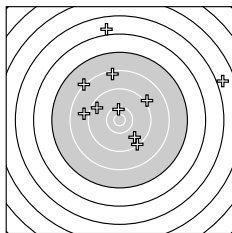

Serie 3:
 5.9 ↑ 9.0 ← 4.9 → 9.3 ↘ 8.2 ↖
 9.5 ↖ 9.7 ↘ 9.1 ↗ 10.4 * 8.4 ↑
 beste Teiler 475.5 (29.) 1001.3 (27.) 1129.7 (26.)
 Trefferlage 2.10 mm rechts, 9.61 mm hoch
 Streuwert 16.33, horizontal: 17.90, vertikal: 14.58

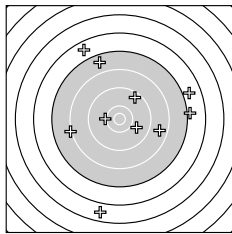

Serie 4:
 9.5 ↗ 8.2 ← 6.9 → 6.7 ↖ 9.9 ↘
 7.7 ↗ 7.1 → 5.7 ↓ 8.7 → 10.2 ←
 beste Teiler 631.0 (40.) 830.9 (35.) 1158.9 (31.)
 Trefferlage 3.23 mm rechts, 2.35 mm hoch
 Streuwert 19.05, horizontal: 18.52, vertikal: 19.57

Unterschrift des Schützen

Meyton Elektronik

Ergebnis: **315** (331.8)
 Serien: 76 84 73 82
 Zähler: 4 9 13 10 0 4 0 0 0 0
 Innenzehner: 0
 weiteste: 4563 (15), 4450 (8), 4369 (21)
 beste Teiler 511.8 (11.) 547.9 (39.) 668.8 (18.)
 Trefferlage 3.13 mm links, 7.89 mm hoch
 Streuwert 15.88, horizontal: 15.66, vertikal: 16.09

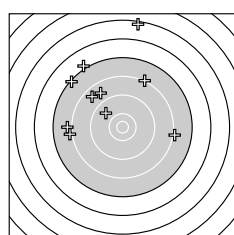
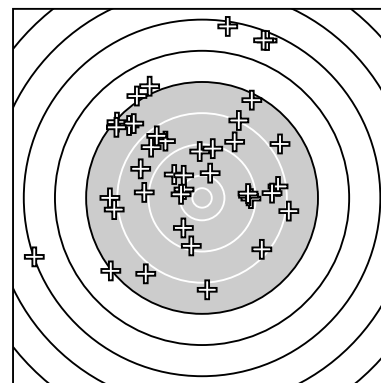

Serie 1:
 7.1 ↖ 8.1 ← 8.2 ↗ 8.6 ↘ 7.3 ↖
 9.8 ↘ 8.1 → 5.4 ↑ 8.8 ↘ 8.0 ←
 beste Teiler 934.0 (6.) 1734.7 (9.) 1846.2 (4.)
 Trefferlage 7.61 mm links, 13.67 mm hoch
 Streuwert 15.18, horizontal: 15.58, vertikal: 14.77

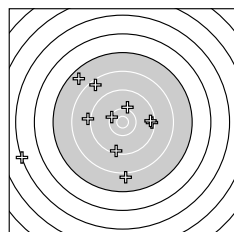

Serie 2:
 10.3 ↘ 7.7 ↘ 9.4 ↓ 9.1 ← 5.2 ←
 8.5 ↘ 8.0 ↓ 10.1 ↑ 9.4 → 9.5 →
 beste Teiler 511.8 (11.) 668.8 (18.) 1193.2 (20.)
 Trefferlage 6.78 mm links, 0.61 mm tief
 Streuwert 14.93, horizontal: 16.45, vertikal: 13.24

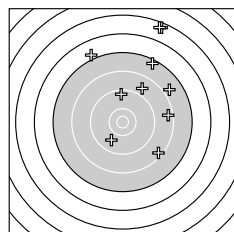

Serie 3:
 5.5 ↗ 7.0 ↘ 7.4 ↗ 9.8 ↙ 8.5 →
 9.5 ↑ 5.5 ↑ 8.4 ↘ 8.9 ↗ 7.9 ↗
 beste Teiler 907.3 (24.) 1192.5 (26.) 1664.2 (29.)
 Trefferlage 8.95 mm rechts, 15.68 mm hoch
 Streuwert 15.31, horizontal: 11.44, vertikal: 18.39

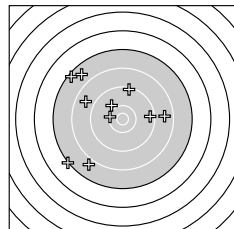

Serie 4:
 7.7 ↘ 7.4 ↘ 9.3 ↑ 8.8 ↘ 8.7 →
 7.2 ↙ 7.9 ↙ 10.0 ↘ 10.3 ← 9.5 →
 beste Teiler 547.9 (39.) 747.7 (38.) 1184.3 (40.)
 Trefferlage 7.07 mm links, 2.82 mm hoch
 Streuwert 13.77, horizontal: 14.20, vertikal: 13.31

Unterschrift des Schützen

Meyton Elektronik

Ergebnis: **287** (304.0)
 Serien: 71 73 74 69
 Zähler: 3 7 10 6 7 4 1 2 0 0
 Innenzehner: 2
 weiteste: 6400 (22), 6148 (1), 5150 (36)
 beste Teiler 349.4 (30.) 395.4 (2.) 641.2 (6.)
 Trefferlage 6.44 mm links, 8.50 mm tief
 Streuwert 20.47, horizontal: 16.61, vertikal: 23.70

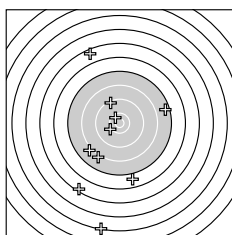
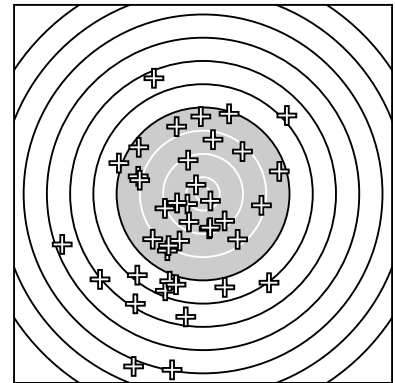

Serie 1:
 3.3 ↓ 10.5 * 5.5 ↗ 6.8 ↓ 5.4 ↘
 10.1 ↙ 8.0 ↖ 9.4 ↗ 8.1 ↘ 7.5 →
 beste Teiler 395.4 (2.) 641.2 (6.) 1269.6 (8.)
 Trefferlage 5.97 mm links, 10.68 mm tief
 Streuwert 22.68, horizontal: 14.31, vertikal: 28.70

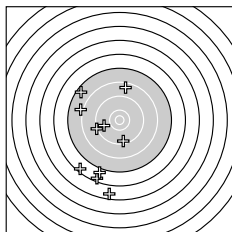

Serie 2:
 6.5 ↓ 7.5 ↖ 9.2 ↖ 6.5 ↘ 5.6 ↓
 6.9 ↓ 9.4 ↓ 8.1 ↖ 9.8 ↖ 8.6 ↑
 beste Teiler 946.5 (19.) 1217.2 (17.) 1402.9 (13.)
 Trefferlage 11.40 mm links, 11.29 mm tief
 Streuwert 16.56, horizontal: 9.45, vertikal: 21.42

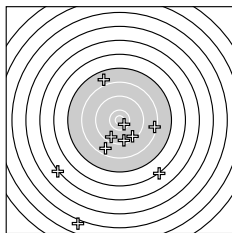

Serie 3:
 9.6 ↘ 3.0 ↓ 9.5 ↓ 6.2 ↘ 8.7 ↘
 9.5 ↘ 8.4 → 5.2 ↖ 7.8 ↗ 10.5 *
 beste Teiler 349.4 (30.) 1079.5 (21.) 1187.5 (23.)
 Trefferlage 2.61 mm links, 14.92 mm tief
 Streuwert 19.93, horizontal: 18.01, vertikal: 21.68

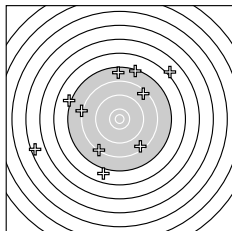

Serie 4:
 8.5 ↘ 8.5 ↗ 8.3 ↘ 6.0 ↗ 7.3 ↑
 4.5 ↖ 8.2 ↖ 7.1 ↖ 7.6 ↑ 6.9 ↓
 beste Teiler 1966.0 (31.) 1991.7 (32.) 2139.4 (33.)
 Trefferlage 5.79 mm links, 2.90 mm hoch
 Streuwert 22.48, horizontal: 23.08, vertikal: 21.86

Unterschrift des Schützen

Meyton Elektronik

Ergebnis: **367** (384.6)
 Serien: 90 90 93 94
 Zähler: 16 16 7 1 0 0 0 0 0 0
 Innenzehner: 7
 weiteste: 2654 (15), 2087 (23), 2039 (38)
 beste Teiler 235.7 (26.) 273.4 (4.) 334.6 (22.)
 Trefferlage 3.94 mm links, 0.45 mm hoch
 Streuwert 8.22, horizontal: 8.49, vertikal: 7.93

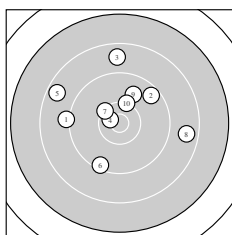
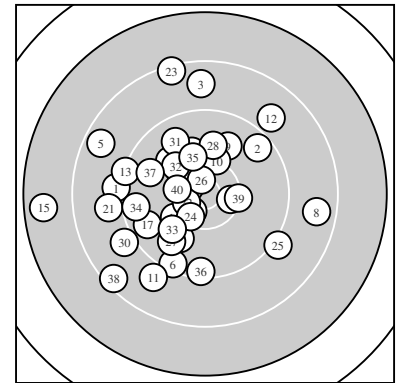

Serie 1:
 9.1 ← 9.5 ↗ 8.7 ↑ 10.6 * 8.6 ↖
 9.4 ↘ 10.3 ↘ 8.6 → 9.9 ↗ 10.2 ↑
 beste Teiler 273.4 (4.) 518.8 (7.) 574.9 (10.)
 Trefferlage 1.15 mm links, 3.81 mm hoch
 Streuwert 9.17, horizontal: 10.36, vertikal: 7.81

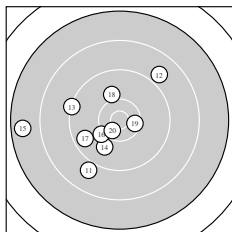

Serie 2:
 8.9 ↘ 8.9 ↗ 9.3 ↖ 9.9 ↘ 7.6 ←
 10.2 ↙ 9.6 ↙ 10.0 ↓ 10.4 * 10.5 *
 beste Teiler 346.5 (20.) 427.5 (19.) 630.4 (16.)
 Trefferlage 5.56 mm links, 1.26 mm tief
 Streuwert 8.82, horizontal: 10.03, vertikal: 7.42

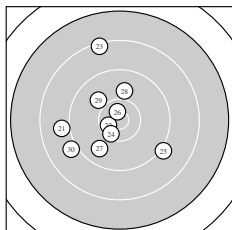

Serie 3:
 9.0 ← 10.5 * 8.3 ↑ 10.4 * 9.1 ↘
 10.7 * 9.8 ↘ 9.9 ↑ 10.0 ↖ 9.0 ↙
 beste Teiler 235.7 (26.) 334.6 (22.) 441.9 (24.)
 Trefferlage 3.85 mm links, 0.43 mm hoch
 Streuwert 8.32, horizontal: 7.67, vertikal: 8.92

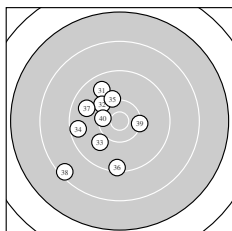

Serie 4:
 9.7 ↖ 10.1 ↖ 10.0 ↙ 9.5 ← 10.2 ↑
 9.4 ↓ 9.7 ↖ 8.4 ↙ 10.3 → 10.4 *
 beste Teiler 462.6 (40.) 551.0 (39.) 636.5 (35.)
 Trefferlage 5.20 mm links, 1.16 mm tief
 Streuwert 6.72, horizontal: 5.70, vertikal: 7.61

Unterschrift des Schützen

Ergebnis:	363	(381.8)
Serien:	89 92 94 88	
Zähler:	12 21 5 2 0 0 0 0 0 0	
Innenzehner:	6	
weiteste:	2926 (36), 2858 (6), 2170 (10)	
beste Teiler	193.2 (19.) 277.3 (29.) 357.2 (22.)	
Trefferlage	3.08 mm links, 1.62 mm tief	
Streuwert	8.85, horizontal: 8.50, vertikal: 9.20	

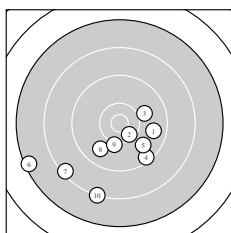
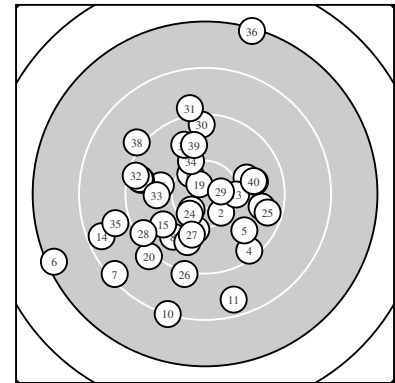

Serie 1:

9.7 →	10.4 *	10.0 →	9.4 ↘	9.8 ↘
7.4 ←	8.3 ↙	9.8 ↙	10.2 ↓	8.2 ↓
beste Teiler	425.5 (2.) 636.4 (9.) 769.5 (3.)			
Trefferlage	2.10 mm links, 7.84 mm tief			
Streuwert	9.44, horizontal: 11.60, vertikal: 6.61			

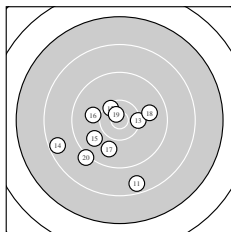

Serie 2:

8.6 ↓	10.4 *	10.3 →	8.5 ←	9.8 ↙
10.0 ←	9.8 ↓	9.8 →	10.7 *	9.1 ↙
beste Teiler	193.2 (19.) 427.4 (12.) 536.0 (13.)			
Trefferlage	3.00 mm links, 4.12 mm tief			
Streuwert	7.55, horizontal: 8.00, vertikal: 7.06			

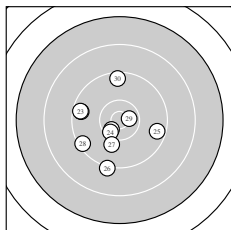

Serie 3:

9.5 ←	10.5 *	9.5 ←	10.4 *	9.5 →
9.2 ↓	10.0 ↓	9.4 ↙	10.6 *	9.5 ↑
beste Teiler	277.3 (29.) 357.2 (22.) 432.6 (24.)			
Trefferlage	3.08 mm links, 1.95 mm tief			
Streuwert	6.89, horizontal: 6.85, vertikal: 6.94			

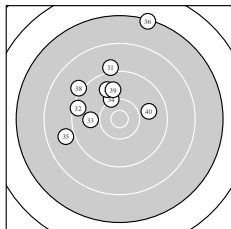

Serie 4:

9.1 ↑	9.4 ←	9.9 ←	10.2 ↗	8.9 ←
7.3 ↑	9.8 ↗	9.1 ↗	9.9 ↑	9.9 →
beste Teiler	615.9 (34.) 835.2 (33.) 865.1 (39.)			
Trefferlage	4.16 mm links, 7.44 mm hoch			
Streuwert	8.61, horizontal: 8.05, vertikal: 9.13			

Unterschrift des Schützen

Meyton Elektronik

Ergebnis: **366** (384.8)
 Serien: 90 92 90 94
 Zähler: 15 17 7 1 0 0 0 0 0 0
 Innenzehner: 8
 weiteste: 2580 (21), 2295 (32), 2121 (20)
 beste Teiler 124.4 (16.) 286.4 (4.) 291.2 (34.)
 Trefferlage 1.46 mm rechts, 3.77 mm tief
 Streuwert 8.26, horizontal: 8.16, vertikal: 8.36

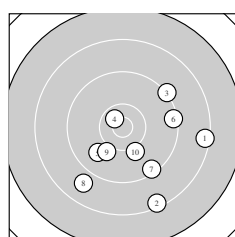
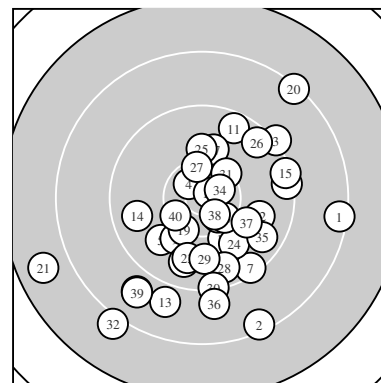

Serie 1:
 8.4 → 8.4 ↓ 9.2 ↗ 10.6 * 9.9 ↘
 9.4 → 9.4 ↓ 8.8 ↙ 10.0 ↖ 10.1 ↓
 beste Teiler 286.4 (4.) 680.3 (10.) 723.3 (9.)
 Trefferlage 4.11 mm rechts, 5.14 mm tief
 Streuwert 8.84, horizontal: 9.51, vertikal: 8.11

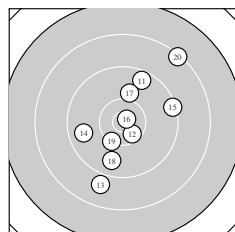

Serie 2:
 9.5 ↗ 10.5 * 8.9 ↓ 9.7 ← 9.3 →
 10.8 * 10.0 ↑ 9.7 ↓ 10.3 ↖ 8.3 ↗
 beste Teiler 124.4 (16.) 375.9 (12.) 547.3 (19.)
 Trefferlage 1.53 mm rechts, 0.29 mm hoch
 Streuwert 8.47, horizontal: 7.36, vertikal: 9.45

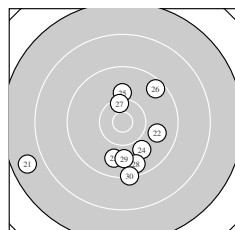

Serie 3:
 7.7 ← 9.8 → 9.8 ↓ 9.9 ↓ 10.0 ↑
 9.5 ↗ 10.4 * 9.6 ↓ 9.8 ↓ 9.3 ↓
 beste Teiler 468.3 (27.) 730.0 (25.) 830.8 (24.)
 Trefferlage 0.02 mm rechts, 4.14 mm tief
 Streuwert 8.56, horizontal: 9.07, vertikal: 8.03

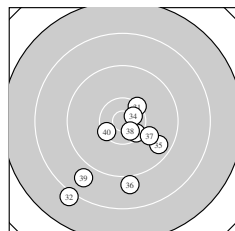

Serie 4:
 10.3 ↗ 8.1 ↙ 10.4 * 10.6 * 9.6 ↘
 9.0 ↓ 10.0 ↘ 10.6 * 8.8 ↖ 10.4 *
 beste Teiler 291.2 (34.) 310.8 (38.) 447.2 (33.)
 Trefferlage 0.20 mm rechts, 6.11 mm tief
 Streuwert 7.28, horizontal: 7.05, vertikal: 7.50

Unterschrift des Schützen

Meyton Elektronik

Ergebnis: **365** (380.5)
 Serien: 91 92 90 92
 Zähler: 14 21 2 2 1 0 0 0 0 0
 Innenzehner: 4
 weiteste: 3294 (10), 2504 (38), 2419 (23)
 beste Teiler 329.6 (35.) 448.0 (22.) 454.7 (24.)
 Trefferlage 0.07 mm rechts, 0.83 mm hoch
 Streuwert 9.34, horizontal: 10.35, vertikal: 8.19

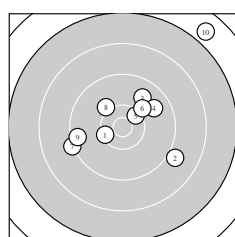
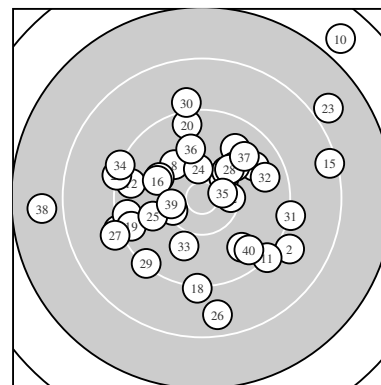

Serie 1:
 10.3 ↙ 9.0 ↘ 9.8 ↗ 9.8 ↗ 10.4 *
 10.1 ↗ 9.2 ↙ 10.1 ↖ 9.5 ↙ 6.8 ↗
 beste Teiler 456.8 (5.) 494.5 (1.) 675.9 (8.)
 Trefferlage 2.35 mm rechts, 3.31 mm hoch
 Streuwert 10.08, horizontal: 10.94, vertikal: 9.13

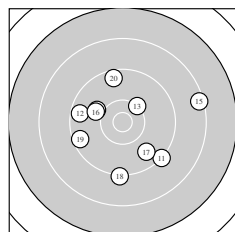

Serie 2:
 9.2 ↘ 9.5 ← 10.2 ↗ 10.0 ↖ 8.4 →
 10.0 ↖ 9.7 ↘ 9.2 ↓ 9.5 ↙ 9.5 ↑
 beste Teiler 564.2 (13.) 738.4 (14.) 750.4 (16.)
 Trefferlage 0.11 mm rechts, 0.63 mm tief
 Streuwert 9.00, horizontal: 9.98, vertikal: 7.89

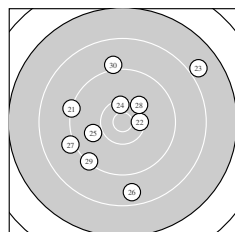

Serie 3:
 9.2 ↖ 10.4 * 7.9 ↗ 10.4 * 9.9 ←
 8.7 ↓ 9.1 ↙ 10.2 ↗ 9.3 ↙ 9.1 ↑
 beste Teiler 448.0 (22.) 454.7 (24.) 618.8 (28.)
 Trefferlage 1.54 mm links, 0.43 mm hoch
 Streuwert 10.16, horizontal: 10.06, vertikal: 10.26

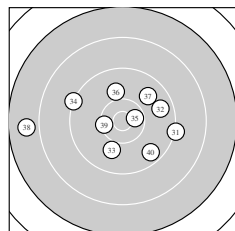

Serie 4:
 9.2 → 9.7 → 10.0 ↓ 9.2 ↖ 10.5 *
 10.0 ↑ 9.8 ↗ 7.8 ← 10.3 ← 9.6 ↘
 beste Teiler 329.6 (35.) 488.9 (39.) 784.2 (36.)
 Trefferlage 0.63 mm links, 0.22 mm hoch
 Streuwert 9.08, horizontal: 11.61, vertikal: 5.48

Unterschrift des Schützen

Meyton Elektronik

Ergebnis: **363** (381.3)
 Serien: 90 91 88 94
 Zähler: 13 18 8 1 0 0 0 0 0 0
 Innenzehner: 5
 weiteste: 2406 (28), 2381 (4), 2305 (16)
 beste Teiler 124.0 (23.) 280.0 (10.) 327.2 (37.)
 Trefferlage 1.22 mm rechts, 1.15 mm tief
 Streuwert 9.10, horizontal: 7.35, vertikal: 10.57

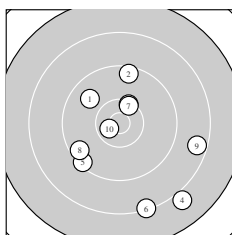
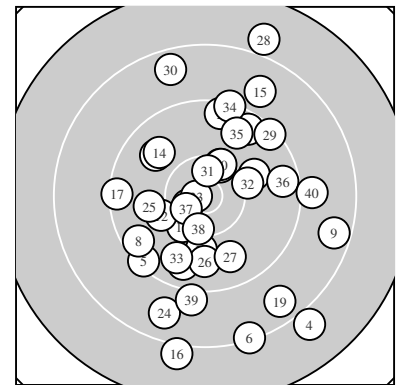

Serie 1:
 9.8 ↘ 9.4 ↑ 10.3 ↗ 8.0 ↘ 9.3 ↙
 8.3 ↓ 10.4 * 9.5 ↖ 8.5 → 10.6 *
 beste Teiler 280.0 (10.) 471.4 (7.) 501.8 (3.)
 Trefferlage 1.85 mm rechts, 3.49 mm tief
 Streuwert 10.07, horizontal: 9.53, vertikal: 10.58

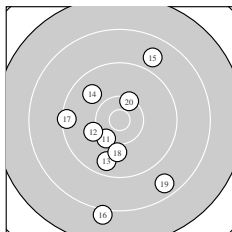

Serie 2:
 10.3 ↗ 10.1 ↖ 9.7 ↓ 9.8 ↘ 8.8 ↗
 8.1 ↓ 9.4 ← 10.0 ↓ 8.6 ↘ 10.3 ↗
 beste Teiler 507.1 (20.) 546.4 (11.) 691.3 (12.)
 Trefferlage 1.56 mm links, 3.64 mm tief
 Streuwert 9.19, horizontal: 7.00, vertikal: 10.96

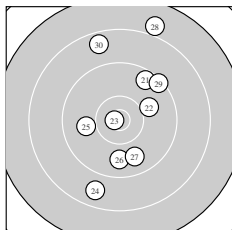

Serie 3:
 9.5 ↗ 10.0 → 10.8 * 8.7 ↓ 9.9 ←
 9.8 ↓ 9.8 ↘ 7.9 ↑ 9.3 ↗ 8.6 ↑
 beste Teiler 124.0 (23.) 771.9 (22.) 816.3 (25.)
 Trefferlage 1.45 mm rechts, 2.57 mm hoch
 Streuwert 9.91, horizontal: 6.36, vertikal: 12.48

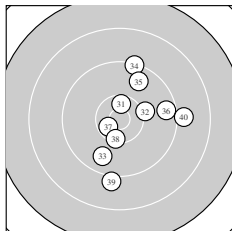

Serie 4:
 10.5 * 10.2 → 9.7 ↓ 9.3 ↑ 9.7 ↗
 9.5 → 10.5 * 10.3 ↓ 9.1 ↓ 9.0 →
 beste Teiler 327.2 (37.) 362.9 (31.) 483.6 (38.)
 Trefferlage 3.15 mm rechts, 0.04 mm tief
 Streuwert 7.31, horizontal: 6.35, vertikal: 8.15

Unterschrift des Schützen

Meyton Elektronik

Ergebnis: **370** (386.8)
 Serien: 92 93 94 91
 Zähler: 16 18 6 0 0 0 0 0 0
 Innenzehner: 6
 weiteste: 2394 (38), 2029 (8), 2029 (15)
 beste Teiler 224.7 (10.) 254.3 (11.) 366.8 (26.)
 Trefferlage 1.61 mm links, 1.31 mm tief
 Streuwert 8.17, horizontal: 7.98, vertikal: 8.35

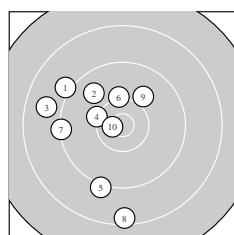
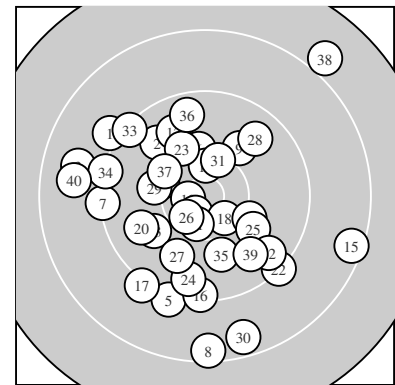

Serie 1:
 9.1 ↘ 9.8 ↘ 8.8 ← 10.2 ↘ 9.2 ↓
 10.2 ↑ 9.3 ← 8.4 ↓ 10.0 ↗ 10.7 *
 beste Teiler 224.7 (10.) 592.9 (4.) 621.5 (6.)
 Trefferlage 5.73 mm links, 0.16 mm tief
 Streuwert 8.21, horizontal: 6.70, vertikal: 9.49

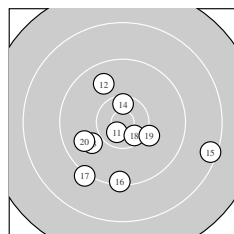

Serie 2:
 10.6 * 9.8 ↘ 9.9 ↙ 10.5 * 8.4 →
 9.3 ↓ 9.2 ↙ 10.5 * 10.1 ↘ 9.8 ↙
 beste Teiler 254.3 (11.) 387.5 (18.) 397.1 (14.)
 Trefferlage 0.16 mm links, 3.57 mm tief
 Streuwert 7.38, horizontal: 8.24, vertikal: 6.39

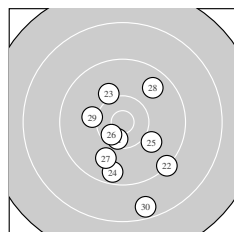

Serie 3:
 10.5 * 9.3 ↘ 10.1 ↘ 9.6 ↓ 10.0 →
 10.5 * 9.9 ↙ 9.7 ↗ 10.1 ← 8.6 ↓
 beste Teiler 366.8 (26.) 384.0 (21.) 674.0 (29.)
 Trefferlage 0.85 mm rechts, 4.27 mm tief
 Streuwert 6.83, horizontal: 5.51, vertikal: 7.94

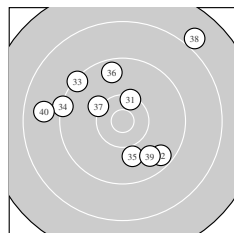

Serie 4:
 10.3 ↗ 9.5 ↘ 9.3 ↘ 9.3 ← 10.0 ↓
 9.6 ↑ 10.2 ↘ 8.0 ↗ 9.7 ↘ 8.8 ←
 beste Teiler 498.8 (31.) 620.6 (37.) 799.1 (35.)
 Trefferlage 1.39 mm links, 2.77 mm hoch
 Streuwert 9.42, horizontal: 10.21, vertikal: 8.55

Unterschrift des Schützen

Meyton Elektronik

Ergebnis: **370** (388.5)
 Serien: 93 92 94 91
 Zähler: 17 17 5 1 0 0 0 0 0 0
 Innenzehner: 8
 weiteste: 2682 (38), 2302 (23), 2091 (16)
 beste Teiler 133.1 (19.) 175.7 (12.) 194.7 (34.)
 Trefferlage 2.96 mm links, 0.98 mm tief
 Streuwert 8.01, horizontal: 7.37, vertikal: 8.60

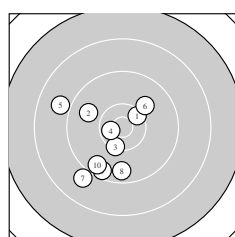
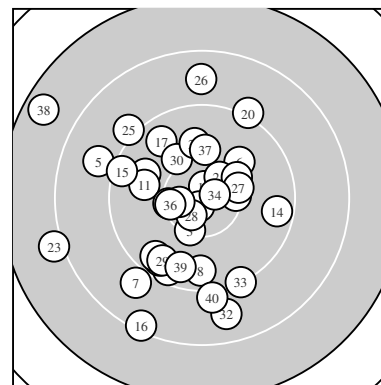

Serie 1:
 10.4 * 9.8 ↖ 10.3 ↓ 10.6 * 8.9 ↖
 10.0 ↗ 9.0 ↙ 9.6 ↓ 9.5 ↓ 9.6 ↓
 beste Teiler 302.0 (4.) 455.7 (1.) 510.0 (3.)
 Trefferlage 4.05 mm links, 3.16 mm tief
 Streuwert 6.79, horizontal: 6.29, vertikal: 7.26

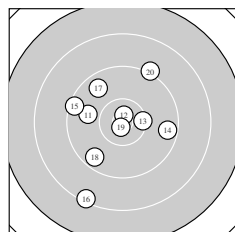

Serie 2:
 9.9 ↖ 10.7 * 10.3 → 9.5 → 9.4 ↖
 8.3 ↓ 9.7 ↘ 9.6 ↙ 10.8 * 9.2 ↗
 beste Teiler 133.1 (19.) 175.7 (12.) 501.0 (13.)
 Trefferlage 1.94 mm links, 0.18 mm tief
 Streuwert 8.23, horizontal: 7.70, vertikal: 8.73

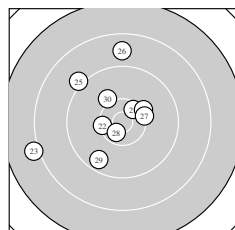

Serie 3:
 10.4 * 10.3 ← 8.1 ← 10.2 ↗ 9.1 ↖
 8.8 ↑ 10.3 → 10.6 * 9.6 ↓ 10.1 ↘
 beste Teiler 298.0 (28.) 404.7 (21.) 503.5 (22.)
 Trefferlage 3.58 mm links, 2.13 mm hoch
 Streuwert 8.05, horizontal: 8.20, vertikal: 7.91

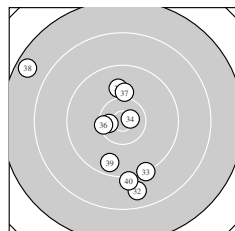

Serie 4:
 9.9 ↑ 8.8 ↓ 9.2 ↓ 10.7 * 10.5 *
 10.4 ← 10.1 ↑ 7.6 ↖ 9.6 ↓ 9.1 ↓
 beste Teiler 194.7 (34.) 340.1 (35.) 478.7 (36.)
 Trefferlage 2.25 mm links, 2.73 mm tief
 Streuwert 9.36, horizontal: 8.13, vertikal: 10.45

Unterschrift des Schützen

Meyton Elektronik

Ergebnis:	364	(382.5)
Serien:	87 92 92 93	
Zähler:	13 21 4 1 1 0 0 0 0 0	
Innenzehner:	7	
weiteste:	3367 (9), 2598 (24), 2088 (20)	
beste Teiler	223.9 (14.) 289.9 (25.) 292.0 (36.)	
Trefferlage	0.73 mm rechts, 0.00 mm	
Streuwert	9.20, horizontal: 10.63, vertikal: 7.49	

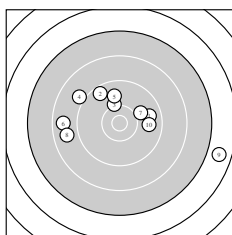
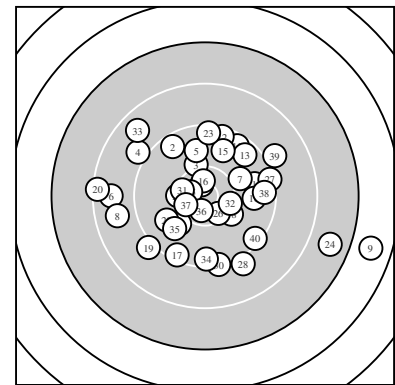

Serie 1:

9.7 →	9.5 ↘	10.2 ↑	9.0 ↙	9.8 ↑
8.7 ←	10.0 →	8.8 ←	6.7 →	9.8 →

beste Teiler 631.1 (3.) 758.0 (7.) 895.2 (5.)
 Trefferlage 0.01 mm rechts, 2.42 mm hoch
 Streuwert 11.66, horizontal: 15.25, vertikal: 6.26

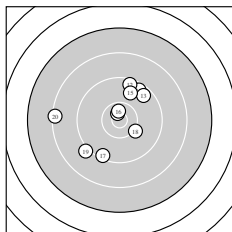

Serie 2:

9.5 ↗	9.5 ↑	9.6 ↗	10.7 *	9.8 ↑
10.6 *	9.4 ↘	10.2 ↘	9.1 ↙	8.3 ←

beste Teiler 223.9 (14.) 293.9 (16.) 621.6 (18.)
 Trefferlage 1.23 mm links, 1.93 mm hoch
 Streuwert 8.51, horizontal: 8.93, vertikal: 8.08

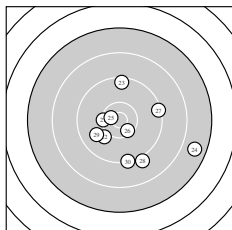

Serie 3:

10.3 ←	10.0 ↙	9.4 ↑	7.7 →	10.6 *
10.4 *	9.3 →	9.1 ↘	9.9 ↙	9.3 ↓

beste Teiler 289.9 (25.) 424.6 (26.) 531.0 (21.)
 Trefferlage 2.96 mm rechts, 3.29 mm tief
 Streuwert 8.80, horizontal: 9.67, vertikal: 7.82

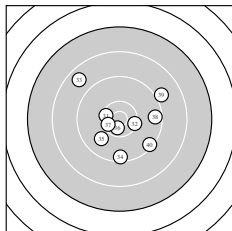

Serie 4:

10.4 *	10.3 →	8.7 ↘	9.4 ↓	9.9 ↙
10.6 *	10.4 *	9.5 →	9.0 →	9.4 ↘

beste Teiler 292.0 (36.) 409.0 (37.) 456.0 (31.)
 Trefferlage 1.20 mm rechts, 1.04 mm tief
 Streuwert 7.96, horizontal: 8.55, vertikal: 7.33

Unterschrift des Schützen

Meyton Elektronik