

Ergebnis: **396** (416.4)
 Serien: 98 99 99 100
 Zähler: 36 4 0 0 0 0 0 0 0 0
 Innenzehner: 33
 weiteste: 358 (4), 321 (20), 317 (28)
 beste Teiler 21.8 (16.) 30.6 (32.) 39.8 (7.)
 Trefferlage 0.00 mm , 0.08 mm tief
 Streuwert 1.12, horizontal: 1.10, vertikal: 1.13

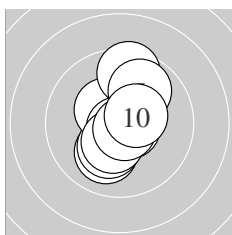

Serie 1:
 10.1 ↘ 10.2 * 10.4 * 9.5 ↑ 9.9 ↗
 10.7 * 10.8 * 10.4 * 10.7 * 10.4 *
 beste Teiler 39.8 (7.) 53.1 (9.) 70.2 (6.)
 Trefferlage 0.09 mm rechts, 0.12 mm hoch
 Streuwert 1.39, horizontal: 0.88, vertikal: 1.76

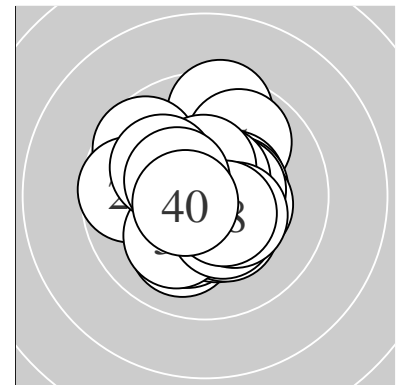
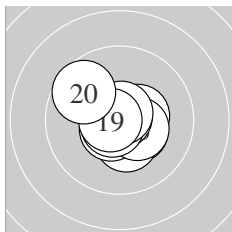

Serie 2:
 10.4 * 10.4 * 10.4 * 10.6 * 10.4 *
 10.9 * 10.7 * 10.7 * 10.7 * 9.7 ↙
 beste Teiler 21.8 (16.) 52.1 (18.) 62.2 (17.)
 Trefferlage 0.00 mm , 0.08 mm tief
 Streuwert 1.06, horizontal: 1.17, vertikal: 0.93

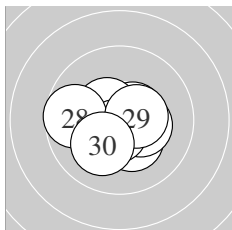

Serie 3:
 10.4 * 10.6 * 10.3 * 10.5 * 10.3 *
 10.5 * 10.6 * 9.7 ← 10.5 * 10.1 ↘
 beste Teiler 83.1 (27.) 88.4 (22.) 102.4 (24.)
 Trefferlage 0.12 mm links, 0.38 mm tief
 Streuwert 1.17, horizontal: 1.44, vertikal: 0.81

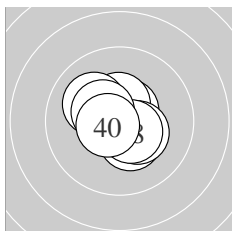

Serie 4:
 10.6 * 10.8 * 10.6 * 10.4 * 10.5 *
 10.4 * 10.1 ↙ 10.5 * 10.4 * 10.6 *
 beste Teiler 30.6 (32.) 89.1 (40.) 91.0 (33.)
 Trefferlage 0.05 mm rechts, 0.02 mm hoch
 Streuwert 0.95, horizontal: 1.01, vertikal: 0.89

Unterschrift des Schützen

Ergebnis:	396	(415.1)
Serien:	98 99 100 99	
Zähler:	36 4 0 0 0 0 0 0 0 0	
Innenzehner:	33	
weiteste:	365 (9), 314 (38), 290 (3)	
beste Teiler	28.6 (32.) 51.4 (6.) 58.0 (10.)	
Trefferlage	0.05 mm links, 0.58 mm hoch	
Streuwert	1.08, horizontal: 1.05, vertikal: 1.12	

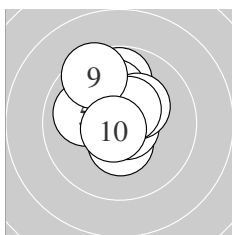
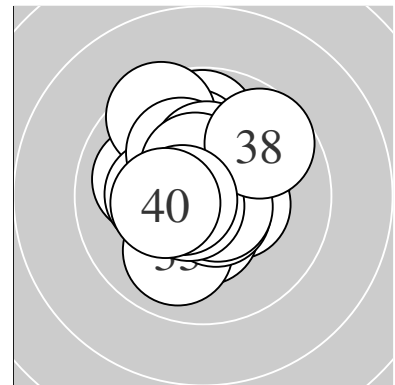

Serie 1:	10.4 *	10.3 *	9.8 ↑	10.1 ↑	10.0 ↖
	10.7 *	10.3 *	10.5 *	9.5 ↗	10.7 *
beste Teiler	51.4 (6.)	58.0 (10.)	110.9 (8.)		
Trefferlage	0.41 mm links, 0.97 mm hoch				
Streuwert	1.30, horizontal: 1.12, vertikal: 1.46				

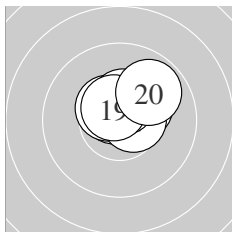

Serie 2:	10.5 *	10.3 *	10.7 *	10.6 *	10.4 *
	10.5 *	10.6 *	10.4 *	10.6 *	9.9 ↗
beste Teiler	71.1 (13.)	88.9 (14.)	92.6 (19.)		
Trefferlage	0.48 mm rechts, 0.90 mm hoch				
Streuwert	0.69, horizontal: 0.87, vertikal: 0.46				

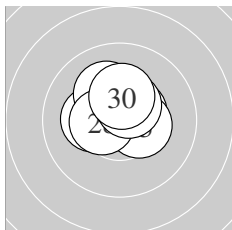

Serie 3:	10.2 *	10.5 *	10.5 *	10.5 *	10.4 *
	10.4 *	10.2 *	10.5 *	10.5 *	10.3 *
beste Teiler	110.9 (22.)	111.0 (24.)	117.9 (29.)		
Trefferlage	0.20 mm links, 0.68 mm hoch				
Streuwert	0.92, horizontal: 1.04, vertikal: 0.77				

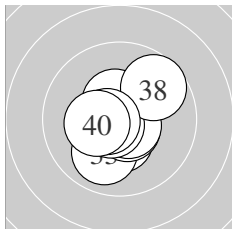

Serie 4:	10.4 *	10.8 *	10.0 ↘	10.6 *	10.5 *
	10.7 *	10.7 *	9.7 ↗	10.6 *	10.3 *
beste Teiler	28.6 (32.)	69.4 (37.)	74.4 (36.)		
Trefferlage	0.06 mm links, 0.20 mm tief				
Streuwert	1.15, horizontal: 1.08, vertikal: 1.22				

Unterschrift des Schützen

Ergebnis: **391** (407.4)
 Serien: 96 98 99 98
 Zähler: 32 7 1 0 0 0 0 0 0
 Innenzehner: 25
 weiteste: 518 (1), 423 (5), 361 (31)
 beste Teiler 68.0 (8.) 72.9 (37.) 85.9 (22.)
 Trefferlage 0.49 mm rechts, 0.11 mm tief
 Streuwert 1.50, horizontal: 1.48, vertikal: 1.52

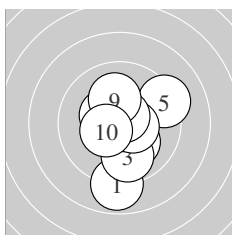
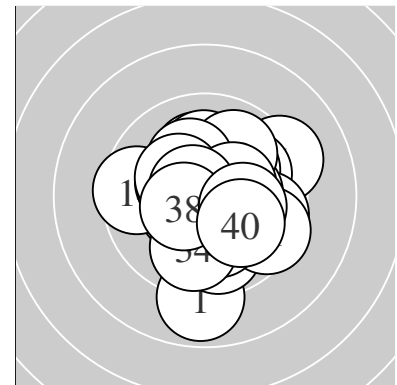

Serie 1:
 8.9 ↓ 10.2 * 9.8 ↓ 10.5 * 9.3 ↗
 10.5 * 10.4 * 10.7 * 10.1 ↑ 10.4 *
 beste Teiler 68.0 (8.) 104.5 (4.) 116.9 (6.)
 Trefferlage 0.36 mm rechts, 0.44 mm tief
 Streuwert 1.90, horizontal: 1.49, vertikal: 2.23

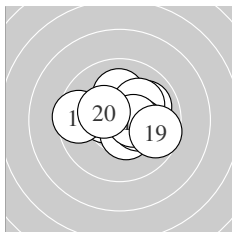

Serie 2:
 10.1 ↑ 10.0 ↗ 10.5 * 9.5 ← 10.4 *
 10.1 ↗ 10.3 * 10.5 * 9.7 → 10.3 *
 beste Teiler 117.1 (18.) 119.3 (13.) 126.1 (15.)
 Trefferlage 0.41 mm rechts, 0.33 mm hoch
 Streuwert 1.57, horizontal: 1.97, vertikal: 1.03

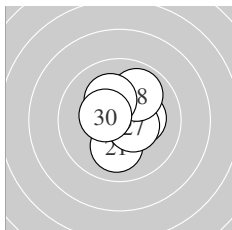

Serie 3:
 10.1 ↓ 10.6 * 10.3 * 10.4 * 10.6 *
 10.3 * 10.5 * 9.9 ↗ 10.2 * 10.4 *
 beste Teiler 85.9 (22.) 89.2 (25.) 125.1 (27.)
 Trefferlage 0.53 mm rechts, 0.43 mm hoch
 Streuwert 1.12, horizontal: 1.01, vertikal: 1.23

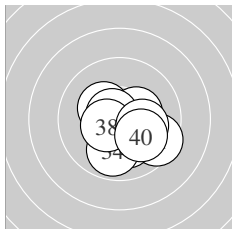

Serie 4:
 9.5 ↘ 10.3 * 10.1 ↓ 9.9 ↓ 10.4 *
 10.3 * 10.7 * 10.5 * 10.2 * 10.0 ↘
 beste Teiler 72.9 (37.) 121.6 (38.) 150.5 (35.)
 Trefferlage 0.67 mm rechts, 0.78 mm tief
 Streuwert 1.35, horizontal: 1.52, vertikal: 1.16

Unterschrift des Schützen

Ergebnis:	396	(414.5)
Serien:	100 99 100 97	
Zähler:	36 4 0 0 0 0 0 0 0 0	
Innenzehner:	30	
weiteste:	349 (32), 308 (17), 284 (31)	
beste Teiler	6.3 (6.) 18.9 (28.) 47.5 (27.)	
Trefferlage	0.12 mm rechts, 0.38 mm hoch	
Streuwert	1.16, horizontal: 1.33, vertikal: 0.97	

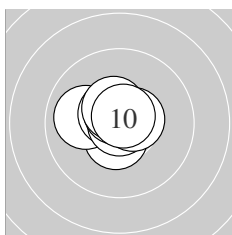
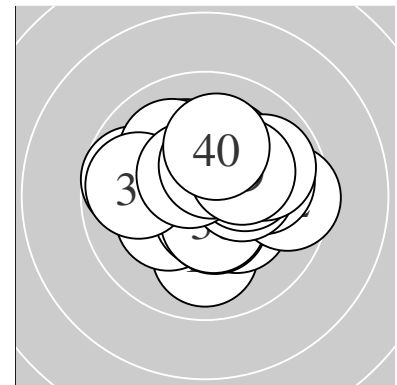

Serie 1:	10.6 *	10.6 *	10.5 *	10.0 ←	10.6 *
	10.9 *	10.6 *	10.5 *	10.6 *	10.7 *
beste Teiler	6.3 (6.)	56.3 (10.)	80.4 (7.)		
Trefferlage	0.44 mm links, 0.33 mm hoch				
Streuwert	0.73, horizontal: 0.86, vertikal: 0.58				

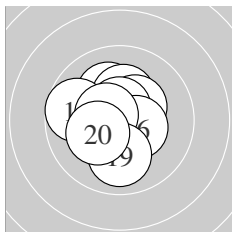

Serie 2:	10.4 *	10.1 ↖	10.3 *	10.4 *	10.6 *
	10.4 *	9.7 ←	10.6 *	10.0 ↓	10.2 *
beste Teiler	80.0 (15.)	100.0 (18.)	126.7 (16.)		
Trefferlage	0.39 mm links, 0.38 mm hoch				
Streuwert	1.28, horizontal: 1.25, vertikal: 1.32				

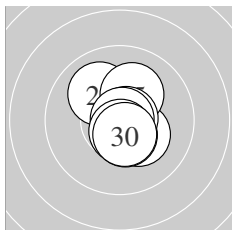

Serie 3:	10.7 *	10.0 ↖	10.7 *	10.3 *	10.2 *
	10.5 *	10.8 *	10.9 *	10.6 *	10.5 *
beste Teiler	18.9 (28.)	47.5 (27.)	54.4 (23.)		
Trefferlage	0.30 mm rechts, 0.03 mm tief				
Streuwert	0.92, horizontal: 0.70, vertikal: 1.09				

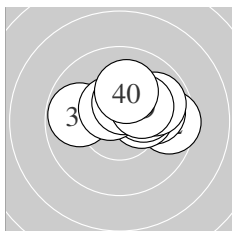

Serie 4:	9.8 ←	9.6 →	10.0 →	10.3 *	10.2 *
	9.9 ↗	10.5 *	10.4 *	10.2 *	10.1 ↑
beste Teiler	110.2 (37.)	132.2 (38.)	159.4 (34.)		
Trefferlage	1.04 mm rechts, 0.85 mm hoch				
Streuwert	1.34, horizontal: 1.80, vertikal: 0.60				

Unterschrift des Schützen

Ergebnis: **388** (404.0)
 Serien: 97 97 98 96
 Zähler: 28 12 0 0 0 0 0 0 0 0
 Innenzehner: 22
 weiteste: 477 (2), 451 (16), 449 (24)
 beste Teiler 6.0 (29.) 17.4 (10.) 59.0 (38.)
 Trefferlage 0.03 mm rechts, 0.42 mm hoch
 Streuwert 1.73, horizontal: 1.95, vertikal: 1.47

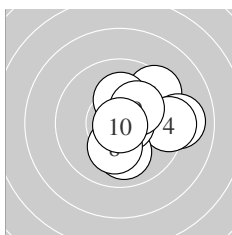
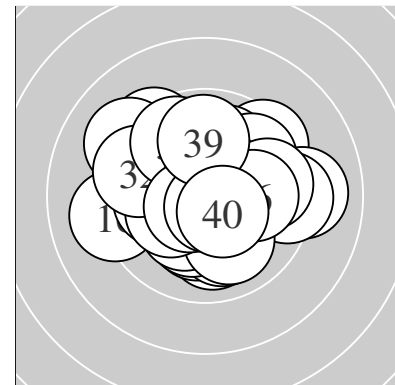

Serie 1:
 9.5 ↗ 9.0 → 10.4 * 9.3 → 10.0 ↓
 10.7 * 10.2 * 10.2 * 10.2 * 10.9 *
 beste Teiler 17.4 (10.) 61.2 (6.) 143.9 (3.)
 Trefferlage 1.40 mm rechts, 0.26 mm hoch
 Streuwert 1.70, horizontal: 1.83, vertikal: 1.55

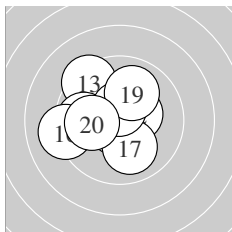

Serie 2:
 10.4 * 10.4 * 9.4 ↘ 10.7 * 9.8 ←
 9.1 ← 10.0 ↓ 10.6 * 10.0 ↑ 10.0 ←
 beste Teiler 68.5 (14.) 92.1 (18.) 138.3 (12.)
 Trefferlage 0.95 mm links, 0.41 mm hoch
 Streuwert 1.75, horizontal: 1.93, vertikal: 1.55

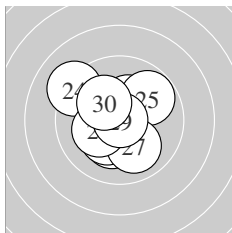

Serie 3:
 10.4 * 10.2 * 10.3 * 9.2 ↘ 9.8 ↗
 10.3 * 10.0 ↓ 10.2 * 10.9 * 10.2 *
 beste Teiler 6.0 (29.) 142.7 (21.) 159.7 (23.)
 Trefferlage 0.47 mm links, 0.24 mm hoch
 Streuwert 1.66, horizontal: 1.65, vertikal: 1.66

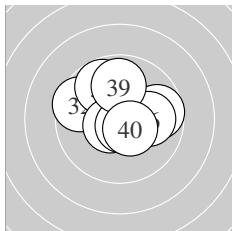

Serie 4:
 10.4 * 9.6 ↖ 9.8 ↘ 10.5 * 9.7 →
 10.0 → 10.6 * 10.7 * 9.9 ↑ 10.5 *
 beste Teiler 59.0 (38.) 92.0 (37.) 103.3 (34.)
 Trefferlage 0.15 mm rechts, 0.77 mm hoch
 Streuwert 1.55, horizontal: 1.79, vertikal: 1.26

Unterschrift des Schützen

Ergebnis: **390** (412.1)
 Serien: 98 98 97 97
 Zähler: 30 10 0 0 0 0 0 0 0 0
 Innenzehner: 26
 weiteste: 383 (20), 360 (15), 307 (40)
 beste Teiler 22.3 (2.) 24.1 (17.) 37.0 (37.)
 Trefferlage 0.35 mm links, 0.06 mm hoch
 Streuwert 1.33, horizontal: 1.54, vertikal: 1.07

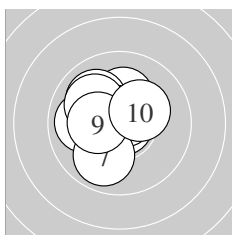
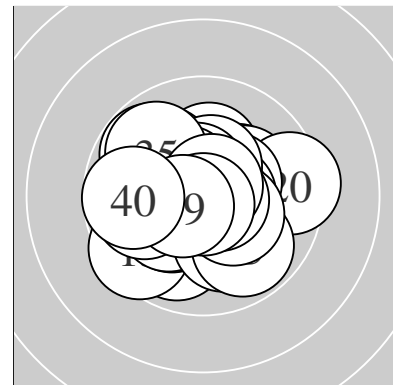

Serie 1:
 10.2 * 10.9 * 10.0 ↘ 10.7 * 9.9 ←
 10.7 * 9.9 ↙ 10.1 ↖ 10.3 * 10.3 *
 beste Teiler 22.3 (2.) 54.7 (4.) 59.3 (6.)
 Trefferlage 0.67 mm links, 0.44 mm hoch
 Streuwert 1.23, horizontal: 1.26, vertikal: 1.20

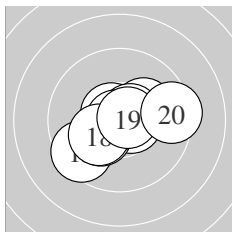

Serie 2:
 10.6 * 10.2 * 10.6 * 10.6 * 9.5 ↙
 10.3 * 10.9 * 10.2 * 10.7 * 9.4 →
 beste Teiler 24.1 (17.) 61.6 (19.) 77.6 (11.)
 Trefferlage 0.12 mm rechts, 0.22 mm tief
 Streuwert 1.49, horizontal: 1.86, vertikal: 0.98

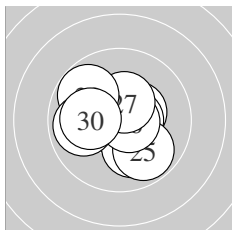

Serie 3:
 10.4 * 10.6 * 10.8 * 10.1 ↘ 9.8 ↘
 10.7 * 10.4 * 9.8 ↖ 9.9 ← 10.1 ←
 beste Teiler 43.4 (23.) 71.1 (26.) 97.0 (22.)
 Trefferlage 0.12 mm links, 0.12 mm tief
 Streuwert 1.44, horizontal: 1.62, vertikal: 1.25

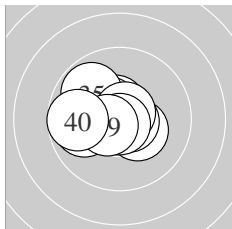

Serie 4:
 10.3 * 10.5 * 10.7 * 10.5 * 9.8 ↘
 10.7 * 10.8 * 9.9 ← 10.6 * 9.7 ←
 beste Teiler 37.0 (37.) 60.4 (36.) 67.4 (33.)
 Trefferlage 0.73 mm links, 0.17 mm hoch
 Streuwert 1.18, horizontal: 1.44, vertikal: 0.85

Unterschrift des Schützen

Ergebnis: **371** (387.0)
 Serien: 86 96 92 97
 Zähler: 18 17 4 0 1 0 0 0 0 0
 Innenzehner: 12
 weiteste: 1050 (10), 732 (3), 644 (4)
 beste Teiler 73.8 (14.) 76.7 (30.) 108.6 (23.)
 Trefferlage 0.32 mm rechts, 0.07 mm hoch
 Streuwert 2.68, horizontal: 3.13, vertikal: 2.13

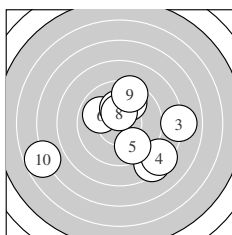
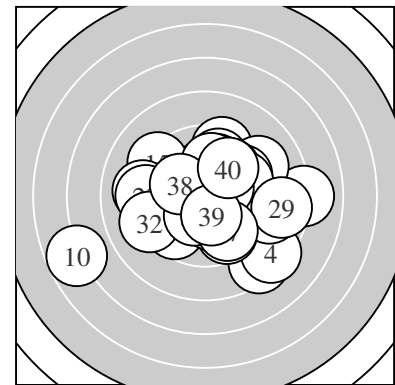

Serie 1:
 8.4 ↘ 9.9 ↗ 8.0 → 8.4 ↘ 9.7 ↘
 9.9 ↖ 10.2 * 10.4 * 9.4 ↑ 6.8 ←
 beste Teiler 132.1 (8.) 183.4 (7.) 255.2 (6.)
 Trefferlage 0.80 mm rechts, 0.61 mm tief
 Streuwert 3.95, horizontal: 4.58, vertikal: 3.19

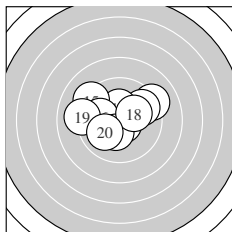

Serie 2:
 9.1 ↗ 9.7 ↗ 10.3 * 10.7 * 9.2 ↘
 10.0 ← 10.3 * 10.2 * 9.1 ← 10.0 ←
 beste Teiler 73.8 (14.) 157.1 (17.) 160.1 (13.)
 Trefferlage 0.39 mm links, 0.59 mm hoch
 Streuwert 2.19, horizontal: 2.75, vertikal: 1.42

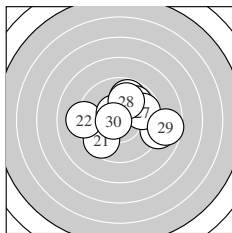

Serie 3:
 9.6 ↙ 9.2 ← 10.5 * 9.0 → 9.8 ↑
 9.9 ↗ 9.8 → 10.0 ↑ 8.7 → 10.6 *
 beste Teiler 76.7 (30.) 108.6 (23.) 249.8 (28.)
 Trefferlage 0.88 mm rechts, 0.44 mm hoch
 Streuwert 2.48, horizontal: 3.08, vertikal: 1.69

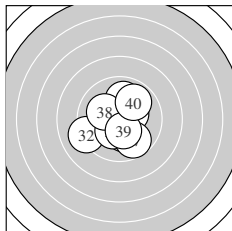

Serie 4:
 10.2 * 9.1 ← 10.4 * 10.1 ↑ 10.0 ↑
 10.3 * 9.7 ↘ 10.1 ↖ 10.4 * 9.9 ↗
 beste Teiler 149.8 (33.) 150.5 (39.) 165.2 (36.)
 Trefferlage 0.02 mm rechts, 0.12 mm tief
 Streuwert 1.86, horizontal: 1.82, vertikal: 1.90

Unterschrift des Schützen

Meyton Elektronik

Ergebnis: **390** (407.0)
 Serien: 97 97 97 99
 Zähler: 30 10 0 0 0 0 0 0 0 0
 Innenzehner: 21
 weiteste: 398 (23), 327 (19), 325 (34)
 beste Teiler 40.1 (28.) 49.7 (37.) 61.2 (22.)
 Trefferlage 0.44 mm rechts, 0.23 mm hoch
 Streuwert 1.47, horizontal: 1.37, vertikal: 1.57

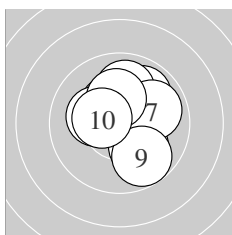
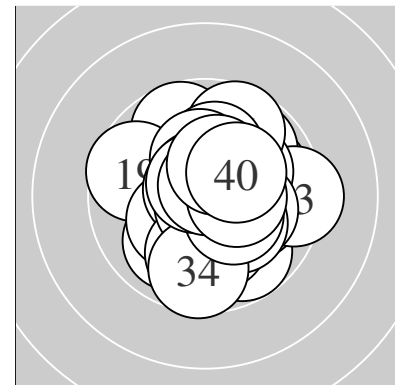

Serie 1:
 10.3 * 9.9 ↗ 10.4 * 10.2 * 10.1 ↘
 10.0 ↑ 9.9 → 10.2 * 9.8 ↘ 10.4 *
 beste Teiler 137.3 (10.) 149.8 (3.) 175.8 (1.)
 Trefferlage 0.40 mm rechts, 0.70 mm hoch
 Streuwert 1.51, horizontal: 1.39, vertikal: 1.63

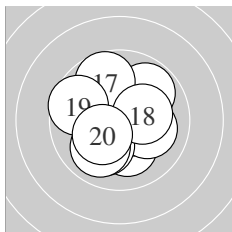

Serie 2:
 10.6 * 9.8 ↗ 10.1 ↓ 10.1 → 10.1 ↘
 10.0 ↙ 9.7 ↘ 10.2 * 9.6 ← 10.3 *
 beste Teiler 80.9 (11.) 168.2 (20.) 176.8 (18.)
 Trefferlage 0.15 mm links, 0.03 mm tief
 Streuwert 1.74, horizontal: 1.73, vertikal: 1.75

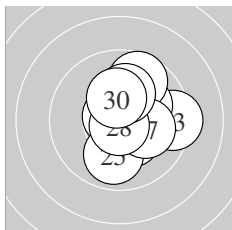

Serie 3:
 10.3 * 10.7 * 9.4 → 10.1 ↗ 9.9 ↓
 9.7 ↑ 10.1 → 10.8 * 10.1 ↑ 10.3 *
 beste Teiler 40.1 (28.) 61.2 (22.) 152.8 (21.)
 Trefferlage 0.89 mm rechts, 0.30 mm hoch
 Streuwert 1.52, horizontal: 1.40, vertikal: 1.63

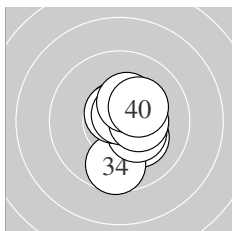

Serie 4:
 10.2 * 10.7 * 10.4 * 9.7 ↓ 10.3 *
 10.7 * 10.8 * 10.4 * 10.4 * 10.3 *
 beste Teiler 49.7 (37.) 70.4 (36.) 75.2 (32.)
 Trefferlage 0.62 mm rechts, 0.03 mm tief
 Streuwert 1.13, horizontal: 0.78, vertikal: 1.39

Unterschrift des Schützen

Ergebnis: **394** (410.5)
 Serien: 98 99 99 98
 Zähler: 34 6 0 0 0 0 0 0 0 0
 Innenzehner: 28
 weiteste: 482 (39), 418 (5), 326 (13)
 beste Teiler 38.6 (1.) 42.1 (11.) 46.6 (37.)
 Trefferlage 0.09 mm links, 0.53 mm tief
 Streuwert 1.37, horizontal: 1.65, vertikal: 1.01

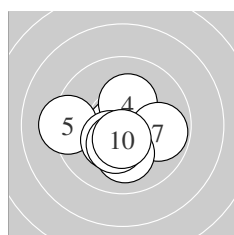
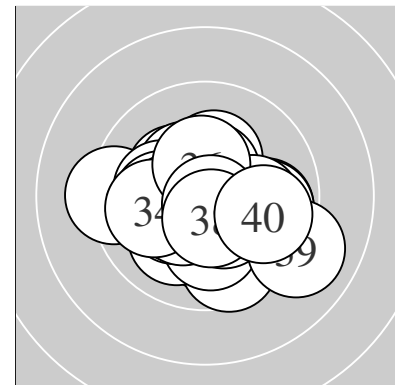

Serie 1:
 10.8 * 10.6 * 10.8 * 10.3 * 9.3 ←
 10.4 * 9.8 → 10.1 ↓ 10.3 * 10.5 *
 beste Teiler 38.6 (1.) 47.4 (3.) 99.2 (2.)
 Trefferlage 0.33 mm links, 0.54 mm tief
 Streuwert 1.41, horizontal: 1.71, vertikal: 1.04

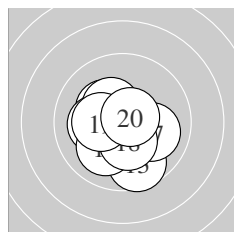

Serie 2:
 10.8 * 10.3 * 9.6 ↓ 10.2 * 10.0 ↙
 10.4 * 10.0 → 10.4 * 10.3 * 10.7 *
 beste Teiler 42.1 (11.) 69.8 (20.) 146.4 (16.)
 Trefferlage 0.26 mm links, 0.50 mm tief
 Streuwert 1.34, horizontal: 1.37, vertikal: 1.32

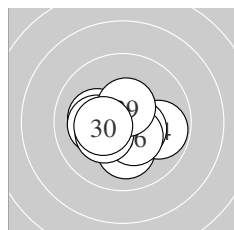

Serie 3:
 10.4 * 10.2 * 10.1 ↓ 9.8 → 10.5 *
 10.4 * 10.2 * 10.3 * 10.5 * 10.3 *
 beste Teiler 116.1 (29.) 123.9 (25.) 137.4 (26.)
 Trefferlage 0.28 mm links, 0.48 mm tief
 Streuwert 1.27, horizontal: 1.58, vertikal: 0.85

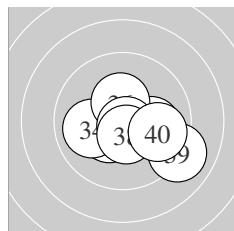

Serie 4:
 10.1 → 10.4 * 10.4 * 10.0 ← 10.8 *
 10.4 * 10.8 * 10.5 * 9.0 → 9.8 →
 beste Teiler 46.6 (37.) 49.5 (35.) 106.7 (38.)
 Trefferlage 0.52 mm rechts, 0.62 mm tief
 Streuwert 1.55, horizontal: 1.97, vertikal: 0.94

Unterschrift des Schützen

Ergebnis: **394** (414.1)
 Serien: 97 98 100 99
 Zähler: 34 6 0 0 0 0 0 0 0 0
 Innenzehner: 29
 weiteste: 320 (6), 319 (2), 284 (20)
 beste Teiler 10.0 (38.) 38.8 (7.) 41.7 (22.)
 Trefferlage 0.19 mm rechts, 0.26 mm hoch
 Streuwert 1.21, horizontal: 1.18, vertikal: 1.24

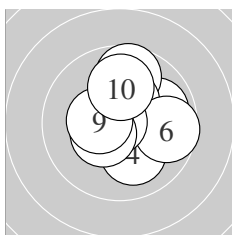
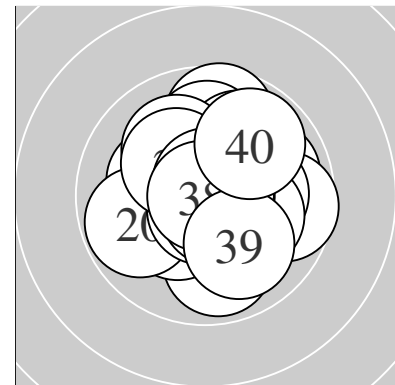

Serie 1:
 9.9 → 9.7 ↑ 10.7 * 10.1 ↓ 10.4 *
 9.7 → 10.8 * 10.4 * 10.4 * 10.0 ↑
 beste Teiler 38.8 (7.) 75.4 (3.) 131.4 (8.)
 Trefferlage 0.52 mm rechts, 0.43 mm hoch
 Streuwert 1.48, horizontal: 1.42, vertikal: 1.55

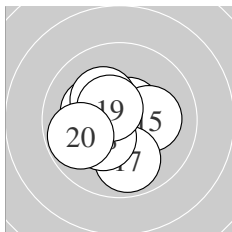

Serie 2:
 10.6 * 10.6 * 10.6 * 10.2 * 10.2 *
 10.2 * 9.9 ↓ 10.3 * 10.5 * 9.8 ←
 beste Teiler 78.3 (13.) 87.9 (12.) 89.1 (11.)
 Trefferlage 0.47 mm links, 0.19 mm tief
 Streuwert 1.27, horizontal: 1.34, vertikal: 1.20

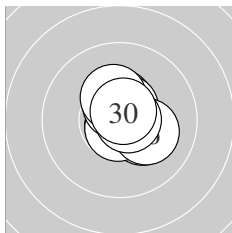

Serie 3:
 10.3 * 10.8 * 10.5 * 10.7 * 10.6 *
 10.2 * 10.5 * 10.3 * 10.7 * 10.7 *
 beste Teiler 41.7 (22.) 55.1 (24.) 58.0 (29.)
 Trefferlage 0.36 mm rechts, 0.26 mm hoch
 Streuwert 0.81, horizontal: 0.75, vertikal: 0.87

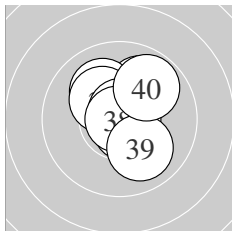

Serie 4:
 10.0 ↗ 10.7 * 10.7 * 10.1 ↘ 10.2 *
 10.7 * 10.7 * 10.9 * 10.0 ↓ 9.8 ↗
 beste Teiler 10.0 (38.) 51.4 (33.) 52.1 (37.)
 Trefferlage 0.37 mm rechts, 0.56 mm hoch
 Streuwert 1.16, horizontal: 1.01, vertikal: 1.30

Unterschrift des Schützen

Ergebnis: **393** (409.4)
 Serien: 99 97 99 98
 Zähler: 33 7 0 0 0 0 0 0 0 0
 Innenzehner: 24
 weiteste: 382 (13), 358 (32), 336 (18)
 beste Teiler 11.0 (21.) 17.6 (9.) 44.5 (25.)
 Trefferlage 0.16 mm links, 0.16 mm tief
 Streuwert 1.44, horizontal: 1.63, vertikal: 1.22

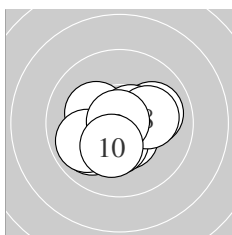
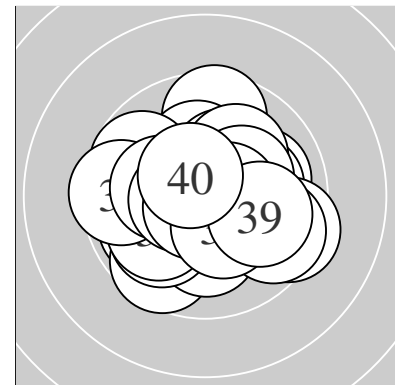

Serie 1:
 10.0 ↙ 10.0 → 10.5 * 10.2 * 9.9 ↙
 10.6 * 10.4 * 10.1 → 10.9 * 10.3 *
 beste Teiler 17.6 (9.) 93.8 (6.) 114.9 (3.)
 Trefferlage 0.12 mm links, 0.42 mm tief
 Streuwert 1.32, horizontal: 1.58, vertikal: 0.99

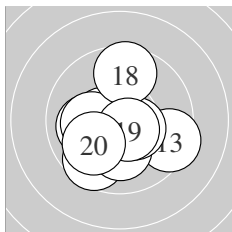

Serie 2:
 10.5 * 10.0 ← 9.4 ↘ 9.6 ↙ 10.1 ↓
 10.5 * 10.2 * 9.6 ↑ 10.6 * 10.0 ↙
 beste Teiler 90.0 (19.) 112.4 (11.) 120.4 (16.)
 Trefferlage 0.33 mm links, 0.64 mm tief
 Streuwert 1.75, horizontal: 1.83, vertikal: 1.66

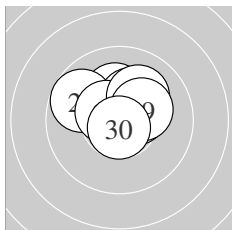

Serie 3:
 10.9 * 10.2 * 9.7 ↘ 10.3 * 10.8 *
 10.5 * 10.5 * 10.1 ↗ 10.3 * 10.7 *
 beste Teiler 11.0 (21.) 44.5 (25.) 53.2 (30.)
 Trefferlage 0.04 mm rechts, 0.80 mm hoch
 Streuwert 1.04, horizontal: 1.26, vertikal: 0.77

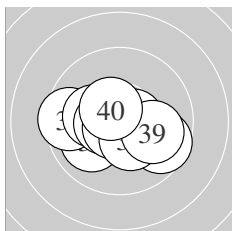

Serie 4:
 10.0 ↙ 9.5 ← 9.6 ↘ 10.2 * 10.5 *
 10.6 * 10.7 * 10.4 * 10.0 → 10.5 *
 beste Teiler 62.3 (37.) 92.1 (36.) 104.2 (35.)
 Trefferlage 0.24 mm links, 0.41 mm tief
 Streuwert 1.53, horizontal: 2.01, vertikal: 0.80

Unterschrift des Schützen

Ergebnis: **392** (410.1)
 Serien: 97 98 99 98
 Zähler: 32 8 0 0 0 0 0 0 0 0
 Innenzehner: 25
 weiteste: 447 (37), 354 (2), 345 (36)
 beste Teiler 40.4 (5.) 55.0 (13.) 57.1 (33.)
 Trefferlage 0.07 mm rechts, 0.68 mm hoch
 Streuwert 1.33, horizontal: 1.32, vertikal: 1.34

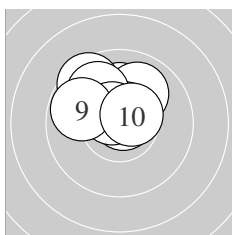
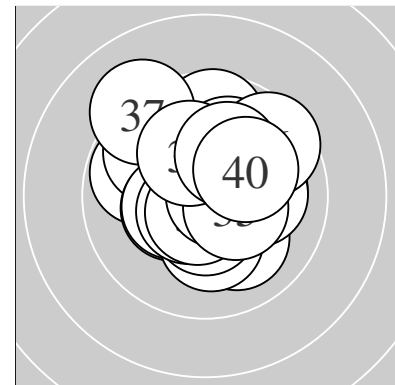

Serie 1:
 10.1 ↑ 9.5 ↘ 10.0 ↗ 10.6 * 10.8 *
 10.3 * 9.9 ↘ 10.6 * 9.8 ↖ 10.5 *
 beste Teiler 40.4 (5.) 78.0 (4.) 87.8 (8.)
 Trefferlage 0.55 mm links, 1.35 mm hoch
 Streuwert 1.11, horizontal: 1.32, vertikal: 0.84

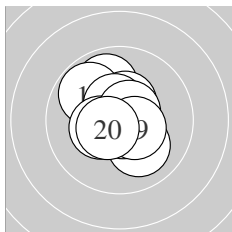

Serie 2:
 9.9 ↖ 10.1 ↘ 10.7 * 10.4 * 9.8 ↖
 10.5 * 10.4 * 10.6 * 10.5 * 10.5 *
 beste Teiler 55.0 (13.) 89.2 (18.) 102.6 (20.)
 Trefferlage 0.18 mm links, 0.33 mm hoch
 Streuwert 1.23, horizontal: 1.12, vertikal: 1.33

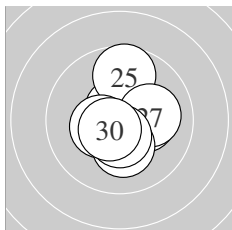

Serie 3:
 10.6 * 10.5 * 10.5 * 10.3 * 9.7 ↑
 10.4 * 10.1 → 10.2 * 10.5 * 10.6 *
 beste Teiler 77.4 (21.) 96.2 (30.) 104.2 (23.)
 Trefferlage 0.36 mm rechts, 0.08 mm tief
 Streuwert 1.23, horizontal: 1.06, vertikal: 1.37

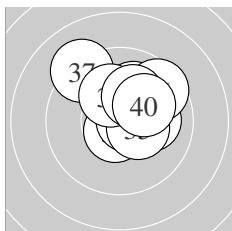

Serie 4:
 10.6 * 10.1 → 10.7 * 10.1 ↗ 10.4 *
 9.6 ↗ 9.2 ↘ 10.2 * 10.2 * 10.1 ↗
 beste Teiler 57.1 (33.) 76.9 (31.) 139.8 (35.)
 Trefferlage 0.67 mm rechts, 1.14 mm hoch
 Streuwert 1.47, horizontal: 1.56, vertikal: 1.38

Unterschrift des Schützen

Ergebnis: **388** (408.7)
 Serien: 97 98 99 94
 Zähler: 28 12 0 0 0 0 0 0 0 0
 Innenzehner: 21
 weiteste: 377 (26), 361 (16), 331 (38)
 beste Teiler 40.3 (9.) 46.0 (18.) 52.9 (22.)
 Trefferlage 0.30 mm rechts, 0.30 mm hoch
 Streuwert 1.47, horizontal: 1.68, vertikal: 1.21

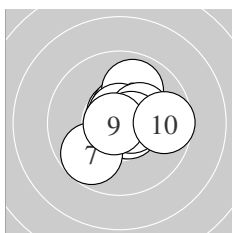
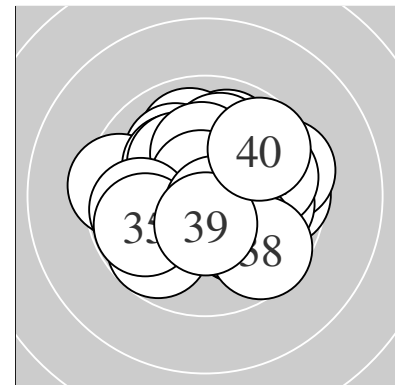

Serie 1:
 10.7 * 10.5 * 9.9 ↗ 10.7 * 10.3 *
 10.7 * 9.8 ↙ 10.6 * 10.8 * 9.7 →
 beste Teiler 40.3 (9.) 65.0 (4.) 72.0 (6.)
 Trefferlage 0.47 mm rechts, 0.30 mm hoch
 Streuwert 1.27, horizontal: 1.37, vertikal: 1.17

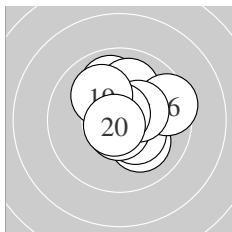

Serie 2:
 10.1 ↘ 10.3 * 9.9 ↗ 10.7 * 10.0 ↗
 9.5 → 10.4 * 10.8 * 10.1 ↘ 10.7 *
 beste Teiler 46.0 (18.) 53.0 (20.) 68.2 (14.)
 Trefferlage 0.56 mm rechts, 0.51 mm hoch
 Streuwert 1.38, horizontal: 1.36, vertikal: 1.39

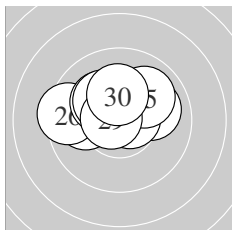

Serie 3:
 10.0 ← 10.7 * 10.0 → 10.6 * 10.0 ↗
 9.4 ← 10.2 * 10.2 * 10.7 * 10.2 *
 beste Teiler 52.9 (22.) 62.5 (29.) 76.9 (24.)
 Trefferlage 0.48 mm links, 0.83 mm hoch
 Streuwert 1.38, horizontal: 1.83, vertikal: 0.67

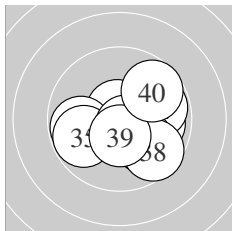

Serie 4:
 9.9 → 9.8 → 10.7 * 9.8 ← 9.8 ↙
 10.0 ↘ 10.7 * 9.6 ↘ 10.5 * 9.7 ↗
 beste Teiler 64.5 (33.) 68.6 (37.) 122.0 (39.)
 Trefferlage 0.65 mm rechts, 0.42 mm tief
 Streuwert 1.72, horizontal: 2.07, vertikal: 1.29

Unterschrift des Schützen

Meyton Elektronik

Ergebnis:	383	(400.0)
Serien:	96	97 98 92
Zähler:	24 15 1 0 0 0 0 0 0 0	
Innenzehner:	17	
weiteste:	555 (35), 418 (6), 383 (39)	
beste Teiler	56.8 (22.) 86.5 (17.) 114.7 (30.)	
Trefferlage	0.23 mm rechts, 0.05 mm hoch	
Streuwert	1.84, horizontal: 1.98, vertikal: 1.69	

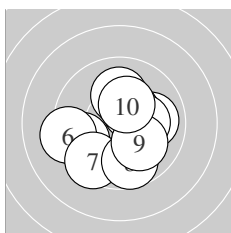
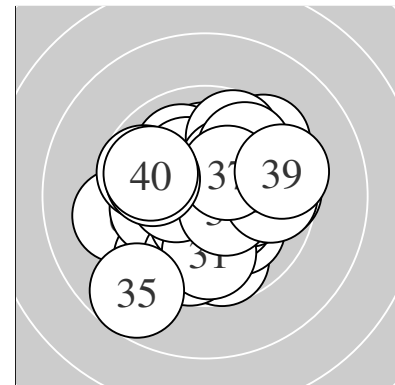

Serie 1:	9.6 ↙	10.0 →	10.1 ↑	10.4 *	10.2 *
	9.3 ↙	9.5 ↙	9.7 ↓	10.1 ↘	10.3 *
beste Teiler	131.5 (4.)	158.2 (10.)	178.1 (5.)		
Trefferlage	0.11 mm links, 0.49 mm tief				
Streuwert	2.00, horizontal: 2.20, vertikal: 1.78				

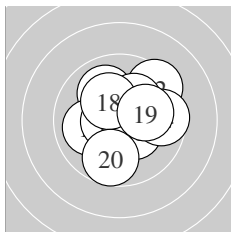

Serie 2:	10.4 *	9.4 ↗	10.0 ↖	9.6 →	10.2 *
	10.0 ←	10.6 *	10.3 *	10.1 →	9.7 ↓
beste Teiler	86.5 (17.)	143.8 (11.)	173.2 (18.)		
Trefferlage	0.45 mm rechts, 0.39 mm hoch				
Streuwert	1.77, horizontal: 1.88, vertikal: 1.65				

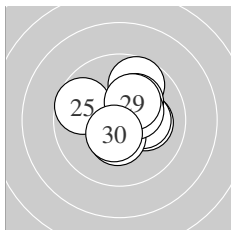

Serie 3:	10.1 →	10.7 *	10.2 *	10.4 *	9.7 ↖
	9.7 ↗	10.2 *	10.4 *	10.2 *	10.5 *
beste Teiler	56.8 (22.)	114.7 (30.)	136.9 (24.)		
Trefferlage	0.47 mm rechts, 0.45 mm hoch				
Streuwert	1.39, horizontal: 1.49, vertikal: 1.28				

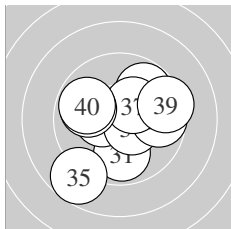

Serie 4:	9.9 ↓	9.8 ↗	10.4 *	10.5 *	8.7 ↙
	9.7 →	10.3 *	9.9 ↖	9.4 →	9.8 ↖
beste Teiler	114.9 (34.)	137.0 (33.)	153.4 (37.)		
Trefferlage	0.12 mm rechts, 0.13 mm tief				
Streuwert	2.25, horizontal: 2.45, vertikal: 2.03				

Unterschrift des Schützen

Ergebnis:	391	(408.9)
Serien:	97	99 97 98
Zähler:	31	9 0 0 0 0 0 0 0 0
Innenzehner:	25	
weiteste:	370	(28), 358 (32), 345 (6)
beste Teiler	57.2	(30.) 71.8 (34.) 72.2 (27.)
Trefferlage	0.51 mm	links, 0.36 mm tief
Streuwert	1.39,	horizontal: 1.63, vertikal: 1.09

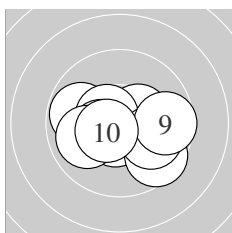
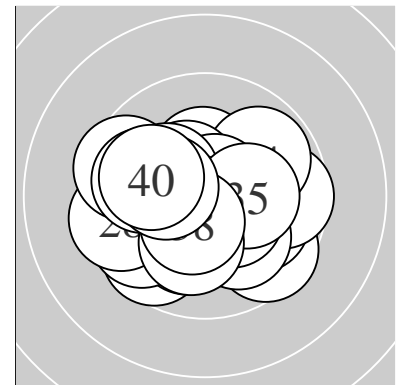

Serie 1:	10.6 *	10.4 *	9.8 ↖	10.5 *	10.4 *
	9.6 ↘	10.0 ↘	10.0 ↖	9.6 →	10.5 *
beste Teiler	92.0	(1.) 104.3 (4.)	107.5 (10.)		
Trefferlage	0.09 mm	rechts, 0.45 mm tief			
Streuwert	1.63,	horizontal: 2.12, vertikal: 0.91			

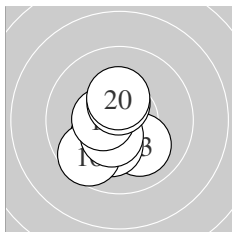

Serie 2:	10.5 *	10.6 *	10.1 ↘	10.3 *	10.2 *
	9.6 ↙	10.5 *	10.5 *	10.5 *	10.3 *
beste Teiler	78.2	(12.) 105.3 (11.)	117.2 (18.)		
Trefferlage	0.54 mm	links, 0.62 mm tief			
Streuwert	1.15,	horizontal: 0.97, vertikal: 1.30			

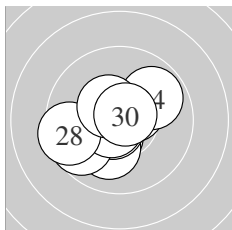

Serie 3:	10.4 *	10.1 ↙	10.5 *	9.8 ↗	10.7 *
	9.7 ↖	10.7 *	9.5 ↖	10.5 *	10.7 *
beste Teiler	57.2	(30.) 72.2 (27.)	73.6 (25.)		
Trefferlage	0.58 mm	links, 0.31 mm tief			
Streuwert	1.44,	horizontal: 1.67, vertikal: 1.18			

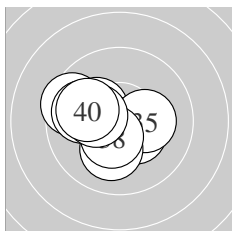

Serie 4:	10.2 *	9.5 ↖	10.4 *	10.7 *	10.2 *
	10.1 ↙	9.9 ↖	10.5 *	10.3 *	10.0 ↖
beste Teiler	71.8	(34.) 123.8 (38.)	138.0 (33.)		
Trefferlage	1.03 mm	links, 0.04 mm tief			
Streuwert	1.35,	horizontal: 1.62, vertikal: 1.02			

Unterschrift des Schützen

Meyton Elektronik

Ergebnis: **389** (406.6)
 Serien: 97 96 99 97
 Zähler: 29 11 0 0 0 0 0 0 0 0
 Innenzehner: 23
 weiteste: 431 (15), 391 (8), 381 (14)
 beste Teiler 13.0 (6.) 20.3 (13.) 29.4 (11.)
 Trefferlage 0.40 mm links, 0.19 mm hoch
 Streuwert 1.58, horizontal: 1.80, vertikal: 1.33

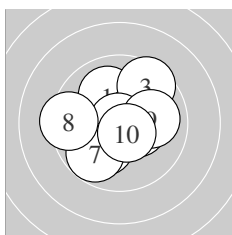
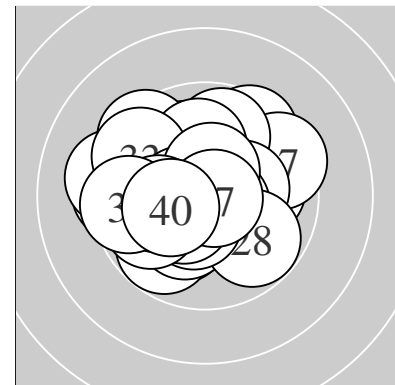

Serie 1:
 10.0 ↖ 10.3 * 9.5 ↗ 10.1 ✓ 10.4 *
 10.9 * 9.8 ↙ 9.4 ← 10.0 → 10.6 *
 beste Teiler 13.0 (6.) 93.0 (10.) 141.4 (5.)
 Trefferlage 0.01 mm links, 0.12 mm hoch
 Streuwert 1.79, horizontal: 1.98, vertikal: 1.58

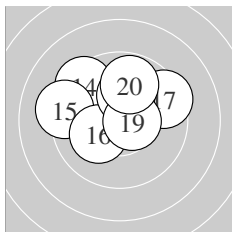

Serie 2:
 10.8 * 10.3 * 10.9 * 9.4 ↘ 9.2 ←
 10.2 * 9.5 → 10.2 * 10.6 * 9.8 ↑
 beste Teiler 20.3 (13.) 29.4 (11.) 96.3 (19.)
 Trefferlage 0.29 mm links, 1.02 mm hoch
 Streuwert 1.75, horizontal: 2.13, vertikal: 1.27

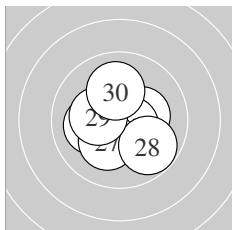

Serie 3:
 10.4 * 10.4 * 10.3 * 10.6 * 10.6 *
 10.1 ← 10.2 * 9.8 ↘ 10.3 * 10.0 ↑
 beste Teiler 77.3 (24.) 85.9 (25.) 131.9 (21.)
 Trefferlage 0.15 mm rechts, 0.23 mm tief
 Streuwert 1.33, horizontal: 1.43, vertikal: 1.22

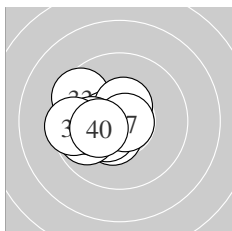

Serie 4:
 10.4 * 10.4 * 9.6 ↘ 10.5 * 10.5 *
 9.9 ← 10.8 * 10.1 ← 9.5 ← 10.3 *
 beste Teiler 43.4 (37.) 104.1 (34.) 116.4 (35.)
 Trefferlage 1.45 mm links, 0.15 mm tief
 Streuwert 1.16, horizontal: 1.34, vertikal: 0.96

Unterschrift des Schützen