

Ergebnis: **390** (407.8)
 Serien: 98 97 99 96
 Zähler: 30 10 0 0 0 0 0 0 0 0
 Innenzehner: 23
 weiteste: 425 (19), 393 (14), 366 (4)
 beste Teiler 38.0 (31.) 41.1 (16.) 46.2 (8.)
 Trefferlage 0.22 mm rechts, 0.54 mm hoch
 Streuwert 1.47, horizontal: 1.57, vertikal: 1.37

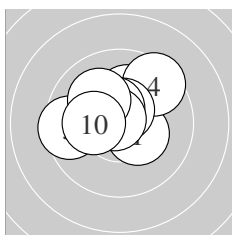

Serie 1:
 10.4 * 10.4 * 10.2 * 9.5 ↗ 9.5 ←
 10.6 * 10.5 * 10.8 * 10.1 ↘ 10.2 *
 beste Teiler 46.2 (8.) 97.7 (6.) 115.5 (7.)
 Trefferlage 0.43 mm links, 0.80 mm hoch
 Streuwert 1.42, horizontal: 1.69, vertikal: 1.08

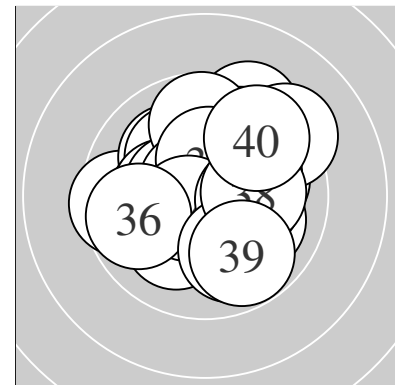
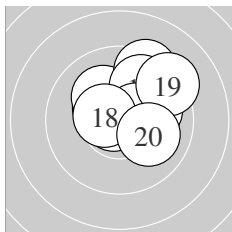

Serie 2:
 10.4 * 10.0 → 10.1 ↘ 9.4 ↗ 9.8 ↗
 10.8 * 10.5 * 10.5 * 9.3 ↗ 10.0 ↘
 beste Teiler 41.1 (16.) 110.7 (18.) 123.3 (17.)
 Trefferlage 0.84 mm rechts, 1.13 mm hoch
 Streuwert 1.51, horizontal: 1.65, vertikal: 1.36

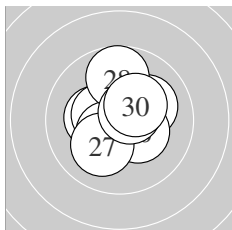

Serie 3:
 10.1 ↗ 10.3 * 10.6 * 10.5 * 10.5 *
 10.3 * 10.1 ↙ 9.7 ↑ 10.6 * 10.3 *
 beste Teiler 85.9 (23.) 90.6 (29.) 125.2 (24.)
 Trefferlage 0.03 mm rechts, 0.35 mm hoch
 Streuwert 1.28, horizontal: 1.24, vertikal: 1.32

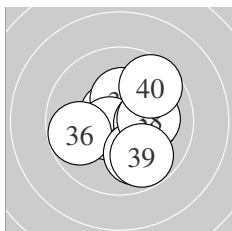

Serie 4:
 10.8 * 10.7 * 10.3 * 10.6 * 10.2 *
 9.8 ← 9.9 ↘ 10.1 → 9.8 ↘ 9.6 ↗
 beste Teiler 38.0 (31.) 75.1 (32.) 88.6 (34.)
 Trefferlage 0.47 mm rechts, 0.12 mm tief
 Streuwert 1.56, horizontal: 1.59, vertikal: 1.53

Unterschrift des Schützen

Meyton Elektronik

Ergebnis: **397** (415.7)
 Serien: 98 100 99 100
 Zähler: 37 3 0 0 0 0 0 0 0 0
 Innenzehner: 34
 weiteste: 300 (28), 297 (10), 258 (5)
 beste Teiler 20.3 (9.) 24.3 (40.) 41.6 (36.)
 Trefferlage 0.03 mm rechts, 0.36 mm tief
 Streuwert 1.08, horizontal: 1.17, vertikal: 0.98

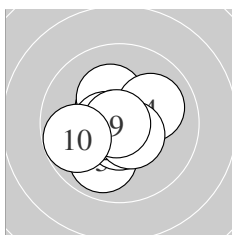
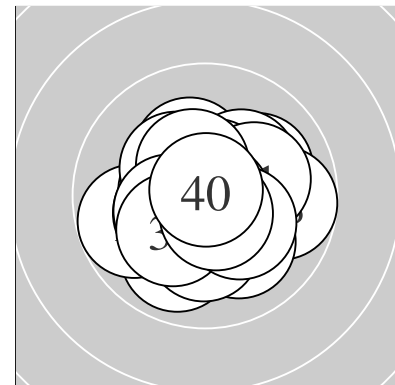

Serie 1:
 10.5 * 10.6 * 10.3 * 10.0 → 9.9 ↙
 10.6 * 10.6 * 10.5 * 10.9 * 9.8 ←
 beste Teiler 20.3 (9.) 85.0 (6.) 92.3 (7.)
 Trefferlage 0.41 mm links, 0.08 mm tief
 Streuwert 1.22, horizontal: 1.25, vertikal: 1.20

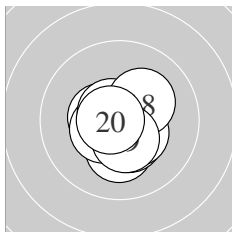

Serie 2:
 10.5 * 10.7 * 10.2 * 10.5 * 10.7 *
 10.4 * 10.4 * 10.2 * 10.4 * 10.7 *
 beste Teiler 61.0 (20.) 72.4 (12.) 73.6 (15.)
 Trefferlage 0.07 mm links, 0.39 mm tief
 Streuwert 0.91, horizontal: 0.90, vertikal: 0.92

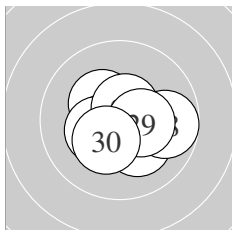

Serie 3:
 10.4 * 10.5 * 10.3 * 10.3 * 10.6 *
 10.5 * 10.2 * 9.8 → 10.4 * 10.3 *
 beste Teiler 89.0 (25.) 101.5 (22.) 121.6 (26.)
 Trefferlage 0.37 mm rechts, 0.45 mm tief
 Streuwert 1.15, horizontal: 1.39, vertikal: 0.84

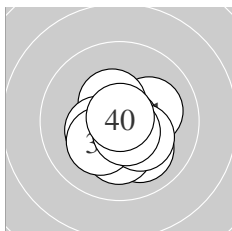

Serie 4:
 10.1 → 10.1 ↘ 10.4 * 10.4 * 10.2 *
 10.8 * 10.2 * 10.3 * 10.6 * 10.9 *
 beste Teiler 24.3 (40.) 41.6 (36.) 82.6 (39.)
 Trefferlage 0.23 mm rechts, 0.55 mm tief
 Streuwert 1.07, horizontal: 1.11, vertikal: 1.04

Unterschrift des Schützen

Ergebnis: **383** (400.6)
 Serien: 98 95 95 95
 Zähler: 24 15 1 0 0 0 0 0 0 0
 Innenzehner: 19
 weiteste: 516 (36), 454 (25), 454 (35)
 beste Teiler 8.0 (6.) 27.3 (28.) 55.3 (40.)
 Trefferlage 0.20 mm links, 0.22 mm tief
 Streuwert 1.89, horizontal: 2.10, vertikal: 1.66

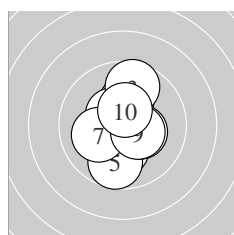
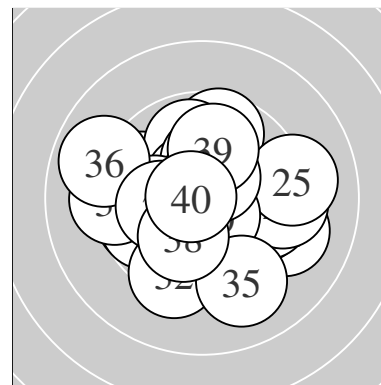

Serie 1:
 10.2 * 10.5 * 9.6 ↑ 10.2 * 9.7 ↓
 10.9 * 10.1 ← 10.3 * 10.4 * 10.4 *
 beste Teiler 8.0 (6.) 117.3 (2.) 126.4 (10.)
 Trefferlage 0.05 mm rechts, 0.03 mm hoch
 Streuwert 1.48, horizontal: 1.02, vertikal: 1.83

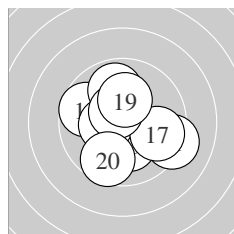

Serie 2:
 9.2 ↘ 10.6 * 10.2 * 9.7 ↖ 10.4 *
 9.9 ↑ 9.8 ↘ 10.5 * 10.2 * 9.6 ↓
 beste Teiler 81.4 (12.) 103.4 (18.) 140.7 (15.)
 Trefferlage 0.01 mm rechts, 0.16 mm tief
 Streuwert 1.92, horizontal: 2.07, vertikal: 1.77

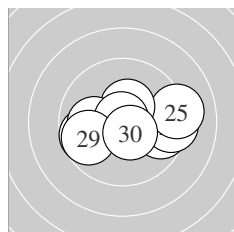

Serie 3:
 9.7 ↘ 9.4 → 10.5 * 9.7 ← 9.1 →
 10.4 * 10.0 ← 10.8 * 9.7 ← 10.5 *
 beste Teiler 27.3 (28.) 106.8 (30.) 116.9 (23.)
 Trefferlage 0.32 mm rechts, 0.21 mm tief
 Streuwert 2.04, horizontal: 2.76, vertikal: 0.84

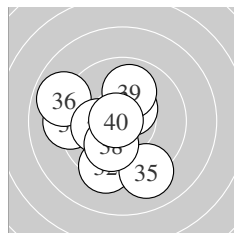

Serie 4:
 10.5 * 9.4 ↓ 9.2 ← 10.4 * 9.1 ↓
 8.9 ↖ 10.1 ← 10.1 ↓ 10.0 ↑ 10.7 *
 beste Teiler 55.3 (40.) 120.4 (31.) 144.0 (34.)
 Trefferlage 1.21 mm links, 0.55 mm tief
 Streuwert 2.14, horizontal: 2.12, vertikal: 2.15

Unterschrift des Schützen

Meyton Elektronik

Ergebnis: **389** (408.1)
 Serien: 96 98 98 97
 Zähler: 30 9 1 0 0 0 0 0 0
 Innenzehner: 21
 weiteste: 540 (6), 341 (8), 336 (23)
 beste Teiler 12.3 (28.) 20.0 (16.) 26.0 (24.)
 Trefferlage 0.36 mm rechts, 0.00 mm
 Streuwert 1.52, horizontal: 1.66, vertikal: 1.37

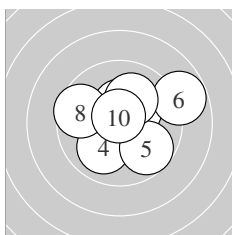
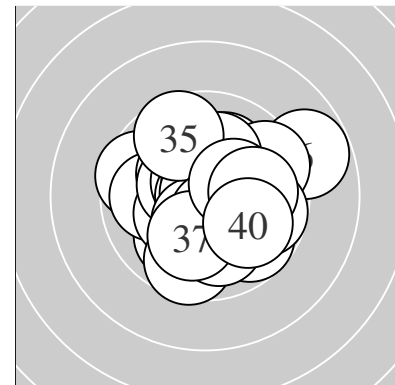

Serie 1:
 10.6 * 10.3 * 10.3 * 10.0 ↙ 9.7 ↘
 8.8 ↗ 10.4 * 9.6 ← 10.1 ↑ 10.7 *
 beste Teiler 60.6 (10.) 97.0 (1.) 144.0 (7.)
 Trefferlage 0.30 mm rechts, 0.35 mm hoch
 Streuwert 1.94, horizontal: 2.25, vertikal: 1.56

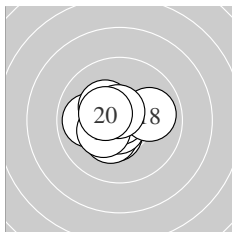

Serie 2:
 10.5 * 10.3 * 9.9 ← 10.7 * 10.3 *
 10.9 * 10.3 * 9.9 → 10.7 * 10.4 *
 beste Teiler 20.0 (16.) 59.2 (14.) 72.3 (19.)
 Trefferlage 0.51 mm links, 0.09 mm tief
 Streuwert 1.11, horizontal: 1.31, vertikal: 0.86

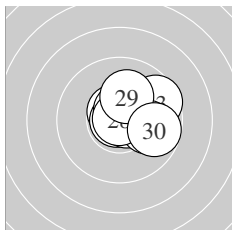

Serie 3:
 10.6 * 10.1 ↗ 9.6 ↗ 10.8 * 10.7 *
 10.0 → 10.6 * 10.9 * 10.1 ↑ 9.8 →
 beste Teiler 12.3 (28.) 26.0 (24.) 58.5 (25.)
 Trefferlage 1.04 mm rechts, 0.46 mm hoch
 Streuwert 1.13, horizontal: 1.33, vertikal: 0.89

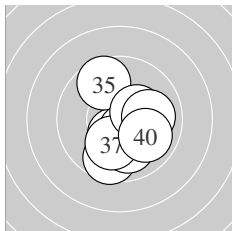

Serie 4:
 9.6 ↓ 10.0 ↓ 10.1 → 10.4 * 9.6 ↖
 10.5 * 10.1 ↓ 10.3 * 10.0 → 9.9 ↘
 beste Teiler 108.6 (36.) 137.5 (34.) 155.8 (38.)
 Trefferlage 0.60 mm rechts, 0.71 mm tief
 Streuwert 1.59, horizontal: 1.38, vertikal: 1.77

Unterschrift des Schützen

Ergebnis:	382	(398.8)
Serien:	93 94 97 98	
Zähler:	25 12 3 0 0 0 0 0 0 0	
Innenzehner:	19	
weiteste:	665 (12), 655 (7), 572 (21)	
beste Teiler	43.9 (24.) 49.2 (29.) 62.1 (30.)	
Trefferlage	0.94 mm links, 0.27 mm hoch	
Streuwert	1.97, horizontal: 1.81, vertikal: 2.11	

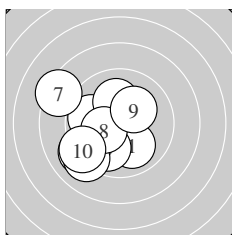
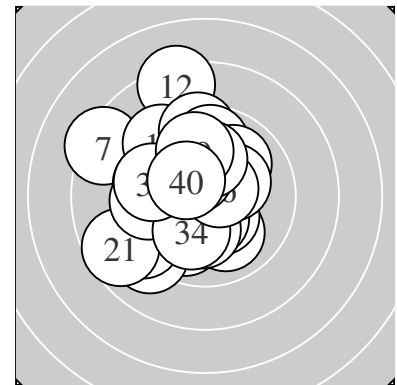

Serie 1:	10.0 ↘	9.8 ←	9.9 ↙	10.1 ↑	9.1 ↘
	9.1 ↙	8.3 ↖	10.3 *	10.2 *	9.2 ↙
beste Teiler	164.7 (8.) 189.5 (9.) 208.7 (4.)				
Trefferlage	1.95 mm links, 0.70 mm tief				
Streuwert	2.28, horizontal: 2.30, vertikal: 2.25				

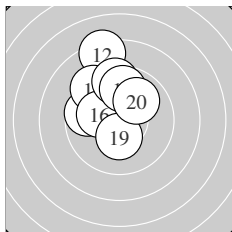

Serie 2:	9.7 ←	8.3 ↑	10.7 *	9.4 ↘	10.5 *
	10.2 *	9.4 ↑	9.7 ↑	10.3 *	10.0 ↗
beste Teiler	68.4 (13.) 114.3 (15.) 158.0 (19.)				
Trefferlage	0.88 mm links, 1.92 mm hoch				
Streuwert	1.87, horizontal: 1.42, vertikal: 2.23				

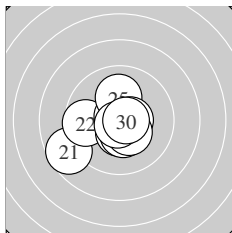

Serie 3:	8.7 ↙	9.6 ←	10.5 *	10.8 *	10.1 ↑
	10.4 *	10.5 *	10.4 *	10.8 *	10.7 *
beste Teiler	43.9 (24.) 49.2 (29.) 62.1 (30.)				
Trefferlage	0.58 mm links, 0.49 mm tief				
Streuwert	1.67, horizontal: 1.93, vertikal: 1.35				

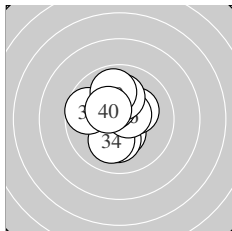

Serie 4:	10.4 *	10.3 *	10.2 *	10.1 ↙	9.7 ←
	10.6 *	10.4 *	10.1 ↑	9.9 ↑	10.4 *
beste Teiler	94.3 (36.) 135.3 (31.) 139.0 (37.)				
Trefferlage	0.34 mm links, 0.36 mm hoch				
Streuwert	1.44, horizontal: 1.24, vertikal: 1.61				

Unterschrift des Schützen

Ergebnis: **391** (408.6)
 Serien: 98 99 98 96
 Zähler: 31 9 0 0 0 0 0 0 0 0
 Innenzehner: 24
 weiteste: 424 (22), 381 (39), 317 (2)
 beste Teiler 25.9 (13.) 47.4 (27.) 82.2 (24.)
 Trefferlage 0.23 mm links, 0.32 mm hoch
 Streuwert 1.45, horizontal: 1.43, vertikal: 1.46

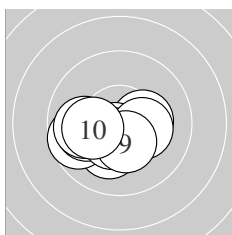
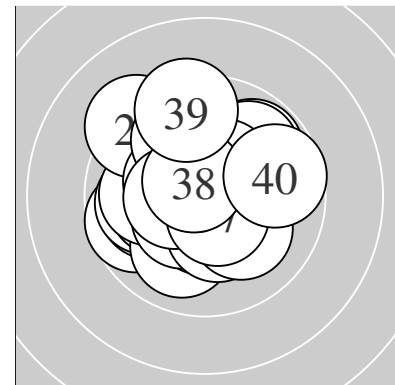

Serie 1:
 10.2 * 9.7 ← 10.3 * 10.0 ← 10.6 *
 10.5 * 9.9 ← 10.3 * 10.4 * 10.2 *
 beste Teiler 82.3 (5.) 123.4 (6.) 141.9 (9.)
 Trefferlage 0.77 mm links, 0.74 mm tief
 Streuwert 1.26, horizontal: 1.68, vertikal: 0.58

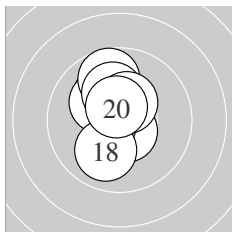

Serie 2:
 10.1 ↖ 10.5 * 10.9 * 10.2 * 9.7 ↑
 10.1 ↑ 10.6 * 10.0 ↓ 10.4 * 10.6 *
 beste Teiler 25.9 (13.) 94.3 (17.) 98.7 (20.)
 Trefferlage 0.34 mm links, 0.82 mm hoch
 Streuwert 1.17, horizontal: 0.72, vertikal: 1.49

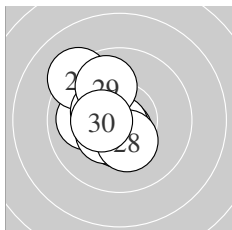

Serie 3:
 10.0 ← 9.3 ↖ 10.5 * 10.6 * 10.4 *
 10.4 * 10.8 * 10.3 * 9.9 ↑ 10.4 *
 beste Teiler 47.4 (27.) 82.2 (24.) 120.2 (23.)
 Trefferlage 0.94 mm links, 0.12 mm hoch
 Streuwert 1.33, horizontal: 1.12, vertikal: 1.52

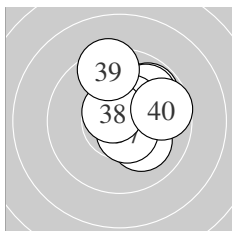

Serie 4:
 10.1 ↘ 9.8 ↗ 10.2 * 10.1 ↗ 9.9 ↗
 10.4 * 10.6 * 10.6 * 9.4 ↑ 9.7 →
 beste Teiler 82.2 (38.) 97.0 (37.) 135.0 (36.)
 Trefferlage 1.11 mm rechts, 1.08 mm hoch
 Streuwert 1.33, horizontal: 1.18, vertikal: 1.46

Unterschrift des Schützen

Ergebnis: **368** (385.3)
 Serien: 91 92 93 92
 Zähler: 18 14 6 2 0 0 0 0 0 0
 Innenzehner: 11
 weiteste: 792 (3), 763 (30), 650 (35)
 beste Teiler 72.7 (1.) 97.1 (23.) 119.0 (40.)
 Trefferlage 0.36 mm rechts, 0.95 mm hoch
 Streuwert 2.62, horizontal: 3.23, vertikal: 1.83

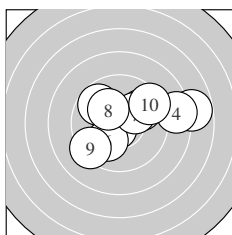
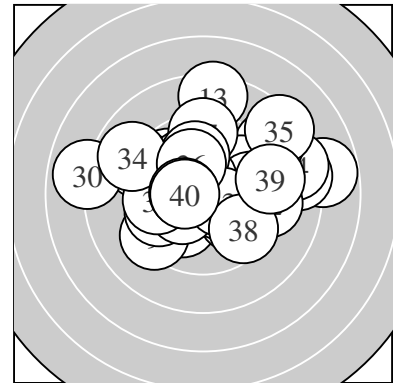

Serie 1:
 10.7 * 9.7 ↘ 7.8 → 8.4 → 9.9 ↗
 10.0 ↙ 10.2 * 10.2 * 9.3 ↙ 9.4 ↗
 beste Teiler 72.7 (1.) 193.9 (8.) 199.4 (7.)
 Trefferlage 1.28 mm rechts, 0.54 mm hoch
 Streuwert 2.84, horizontal: 3.65, vertikal: 1.68

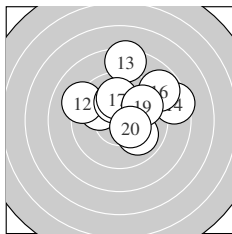

Serie 2:
 10.0 ↘ 9.2 ↘ 8.4 ↑ 8.5 → 10.2 *
 8.8 ↗ 10.0 ↑ 10.0 ↘ 9.8 ↗ 10.4 *
 beste Teiler 138.9 (20.) 200.4 (15.) 237.6 (17.)
 Trefferlage 0.94 mm rechts, 1.79 mm hoch
 Streuwert 2.57, horizontal: 2.94, vertikal: 2.14

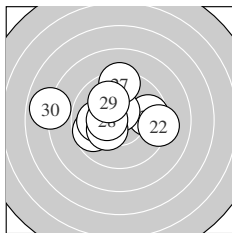

Serie 3:
 9.7 → 9.2 → 10.6 * 9.7 ← 10.0 ←
 10.3 * 9.4 ↑ 10.4 * 10.0 ↘ 7.9 ←
 beste Teiler 97.1 (23.) 137.0 (28.) 169.2 (26.)
 Trefferlage 0.94 mm links, 0.58 mm hoch
 Streuwert 2.54, horizontal: 3.24, vertikal: 1.56

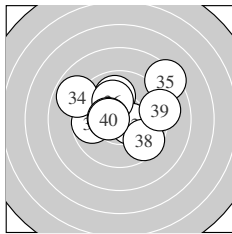

Serie 4:
 9.8 ← 9.9 ↑ 10.4 * 8.9 ↘ 8.4 ↗
 10.1 ↘ 10.4 * 9.6 ↘ 9.2 → 10.5 *
 beste Teiler 119.0 (40.) 126.2 (37.) 128.9 (33.)
 Trefferlage 0.18 mm rechts, 0.89 mm hoch
 Streuwert 2.56, horizontal: 3.09, vertikal: 1.89

Unterschrift des Schützen

Meyton Elektronik

Ergebnis:	394	(410.1)
Serien:	100 98 99 97	
Zähler:	34 6 0 0 0 0 0 0 0 0	
Innenzehner:	28	
weiteste:	436 (36), 280 (35), 269 (16)	
beste Teiler	76.2 (6.) 77.2 (5.) 84.0 (12.)	
Trefferlage	0.03 mm links, 0.48 mm hoch	
Streuwert	1.29, horizontal: 1.41, vertikal: 1.16	

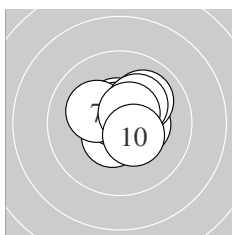
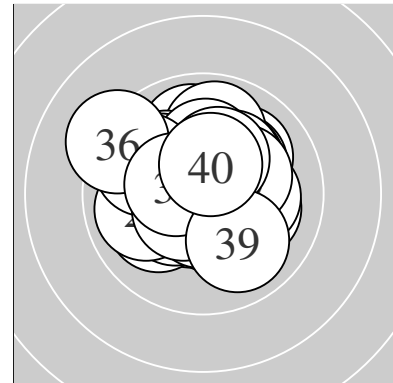

Serie 1:	10.4 *	10.5 *	10.5 *	10.0 ↗	10.6 *
	10.6 *	10.2 *	10.2 *	10.5 *	10.4 *
beste Teiler	76.2 (6.)	77.2 (5.)	101.1 (9.)		
Trefferlage	0.29 mm rechts, 0.49 mm hoch				
Streuwert	0.98, horizontal: 1.08, vertikal: 0.87				

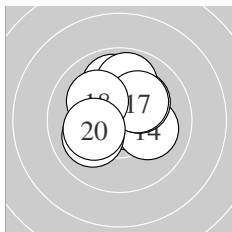

Serie 2:	9.9 ↑	10.6 *	10.5 *	10.1 ↘	10.2 *
	9.9 ↑	10.2 *	10.1 ↙	10.0 ↙	10.2 *
beste Teiler	84.0 (12.)	113.1 (13.)	185.9 (17.)		
Trefferlage	0.03 mm rechts, 0.79 mm hoch				
Streuwert	1.39, horizontal: 1.45, vertikal: 1.33				

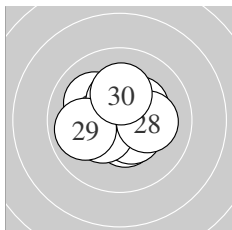

Serie 3:	10.1 ↘	10.5 *	10.3 *	10.6 *	10.4 *
	10.4 *	10.4 *	10.1 →	9.9 ←	10.2 *
beste Teiler	90.4 (24.)	123.9 (22.)	126.7 (25.)		
Trefferlage	0.18 mm links, 0.12 mm hoch				
Streuwert	1.28, horizontal: 1.41, vertikal: 1.12				

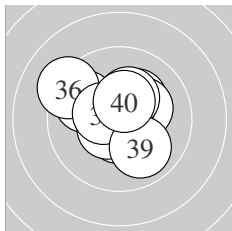

Serie 4:	10.2 *	10.2 *	10.3 *	10.6 *	9.8 ↘
	9.2 ↘	10.5 *	10.5 *	9.9 ↘	10.4 *
beste Teiler	98.3 (34.)	107.6 (37.)	124.9 (38.)		
Trefferlage	0.30 mm links, 0.53 mm hoch				
Streuwert	1.57, horizontal: 1.77, vertikal: 1.34				

Unterschrift des Schützen

Meyton Elektronik

Ergebnis: **398** (419.1)
 Serien: 99 100 99 100
 Zähler: 38 2 0 0 0 0 0 0 0 0
 Innenzehner: 36
 weiteste: 407 (5), 271 (27), 211 (13)
 beste Teiler 28.1 (40.) 29.2 (15.) 37.9 (34.)
 Trefferlage 0.24 mm links, 0.32 mm hoch
 Streuwert 0.95, horizontal: 1.09, vertikal: 0.79

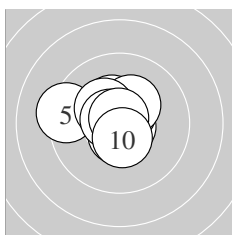
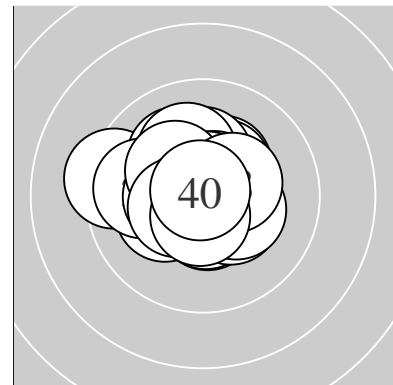

Serie 1:
 10.4 * 10.6 * 10.7 * 10.6 * 9.3 ←
 10.3 * 10.3 * 10.6 * 10.8 * 10.5 *
 beste Teiler 38.6 (9.) 54.1 (3.) 78.0 (8.)
 Trefferlage 0.46 mm links, 0.39 mm hoch
 Streuwert 1.16, horizontal: 1.38, vertikal: 0.87

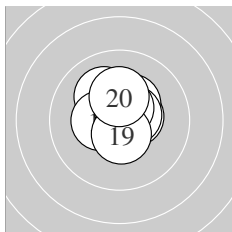

Serie 2:
 10.7 * 10.5 * 10.1 ↖ 10.4 * 10.8 *
 10.6 * 10.4 * 10.6 * 10.5 * 10.2 *
 beste Teiler 29.2 (15.) 54.0 (11.) 97.4 (18.)
 Trefferlage 0.12 mm rechts, 0.56 mm hoch
 Streuwert 0.85, horizontal: 0.83, vertikal: 0.87

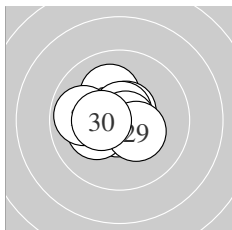

Serie 3:
 10.7 * 10.1 ↖ 10.6 * 10.7 * 10.7 *
 10.2 * 9.9 ← 10.8 * 10.4 * 10.4 *
 beste Teiler 45.5 (28.) 53.4 (24.) 66.9 (25.)
 Trefferlage 0.48 mm links, 0.18 mm hoch
 Streuwert 1.02, horizontal: 1.18, vertikal: 0.82

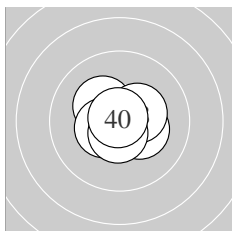

Serie 4:
 10.5 * 10.7 * 10.8 * 10.8 * 10.3 *
 10.5 * 10.3 * 10.4 * 10.6 * 10.8 *
 beste Teiler 28.1 (40.) 37.9 (34.) 50.9 (33.)
 Trefferlage 0.13 mm links, 0.15 mm hoch
 Streuwert 0.80, horizontal: 0.94, vertikal: 0.63

Unterschrift des Schützen

Meyton Elektronik

Ergebnis: **392** (413.0)
 Serien: 97 99 99 97
 Zähler: 32 8 0 0 0 0 0 0 0 0
 Innenzehner: 28
 weiteste: 398 (37), 335 (31), 330 (3)
 beste Teiler 35.6 (14.) 38.1 (23.) 41.2 (36.)
 Trefferlage 0.14 mm links, 0.11 mm hoch
 Streuwert 1.31, horizontal: 1.42, vertikal: 1.19

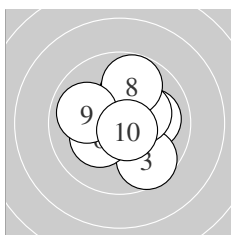
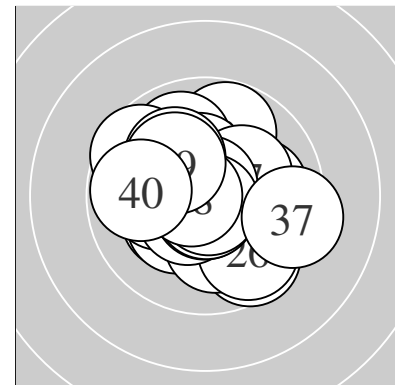

Serie 1:
 10.0 → 10.6 * 9.6 ↘ 10.1 ↑ 10.7 *
 10.2 * 10.3 * 9.8 ↑ 9.9 ← 10.7 *
 beste Teiler 53.0 (5.) 75.6 (10.) 89.1 (2.)
 Trefferlage 0.44 mm rechts, 0.20 mm hoch
 Streuwert 1.51, horizontal: 1.50, vertikal: 1.51

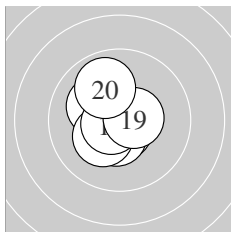

Serie 2:
 10.5 * 10.7 * 10.7 * 10.8 * 10.5 *
 10.2 * 10.3 * 10.7 * 10.5 * 9.9 ↘
 beste Teiler 35.6 (14.) 59.8 (12.) 68.0 (18.)
 Trefferlage 0.43 mm links, 0.03 mm hoch
 Streuwert 0.96, horizontal: 0.85, vertikal: 1.07

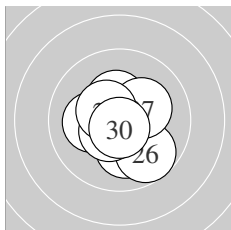

Serie 3:
 10.7 * 10.4 * 10.8 * 10.2 * 10.1 ↓
 9.7 ↘ 10.2 * 10.5 * 10.5 * 10.7 *
 beste Teiler 38.1 (23.) 56.9 (21.) 57.0 (30.)
 Trefferlage 0.01 mm rechts, 0.20 mm tief
 Streuwert 1.20, horizontal: 1.16, vertikal: 1.25

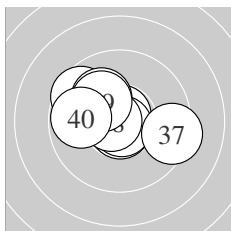

Serie 4:
 9.6 ↘ 10.7 * 10.4 * 10.8 * 10.1 ↘
 10.8 * 9.4 → 10.7 * 10.2 * 9.8 ←
 beste Teiler 41.2 (36.) 42.7 (34.) 55.2 (32.)
 Trefferlage 0.61 mm links, 0.43 mm hoch
 Streuwert 1.52, horizontal: 1.92, vertikal: 0.95

Unterschrift des Schützen

Ergebnis:	377	(395.7)
Serien:	93 92 97 95	
Zähler:	21 15 4 0 0 0 0 0 0 0	
Innenzehner:	17	
weiteste:	741 (38), 524 (1), 515 (4)	
beste Teiler	54.0 (24.) 59.9 (32.) 66.4 (9.)	
Trefferlage	0.22 mm links, 0.93 mm hoch	
Streuwert	2.07, horizontal: 2.27, vertikal: 1.84	

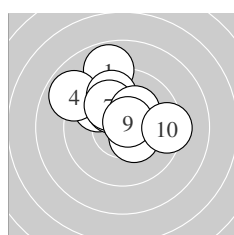
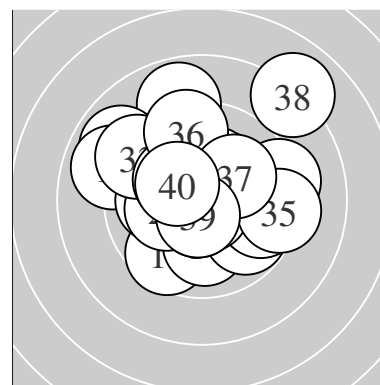

Serie 1:	8.9 ↑	9.8 ↘	10.4 *	8.9 ↘	10.2 *
	9.8 ↑	10.0 ↘	10.2 *	10.7 *	9.4 →
beste Teiler	66.4 (9.)	136.0 (3.)	180.0 (8.)		
Trefferlage	0.43 mm links, 1.71 mm hoch				
Streuwert	1.97, horizontal: 2.22, vertikal: 1.68				

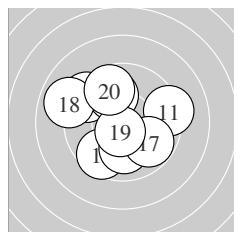

Serie 2:	9.3 →	10.2 *	9.6 ↙	10.0 ↓	9.4 ↘
	9.9 ↑	9.8 ↘	8.9 ↘	10.6 *	9.7 ↑
beste Teiler	85.8 (19.)	195.0 (12.)	235.4 (14.)		
Trefferlage	0.50 mm links, 0.05 mm hoch				
Streuwert	2.38, horizontal: 2.55, vertikal: 2.20				

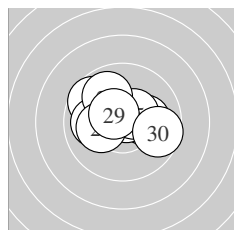

Serie 3:	9.7 ↘	10.2 *	10.0 ←	10.7 *	10.5 *
	10.4 *	9.9 ↑	10.2 *	10.5 *	9.7 →
beste Teiler	54.0 (24.)	106.8 (29.)	123.0 (25.)		
Trefferlage	0.38 mm links, 0.53 mm hoch				
Streuwert	1.53, horizontal: 1.94, vertikal: 0.95				

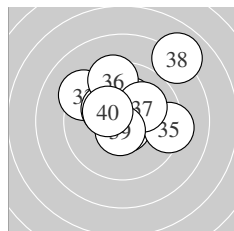

Serie 4:	10.2 *	10.7 *	9.3 ↘	10.2 *	9.3 →
	9.5 ↑	10.1 ↗	8.0 ↗	10.6 *	10.3 *
beste Teiler	59.9 (32.)	85.8 (39.)	158.3 (40.)		
Trefferlage	0.42 mm rechts, 1.44 mm hoch				
Streuwert	2.30, horizontal: 2.56, vertikal: 2.02				

Unterschrift des Schützen

Meyton Elektronik

Ergebnis: **381** (399.7)
 Serien: 93 96 95 97
 Zähler: 22 17 1 0 0 0 0 0 0 0
 Innenzehner: 17
 weiteste: 609 (36), 472 (15), 442 (17)
 beste Teiler 17.0 (39.) 27.8 (14.) 32.6 (32.)
 Trefferlage 0.31 mm rechts, 0.34 mm hoch
 Streuwert 1.98, horizontal: 2.09, vertikal: 1.87

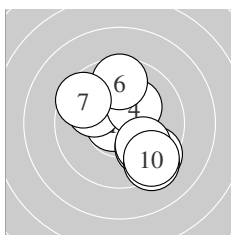
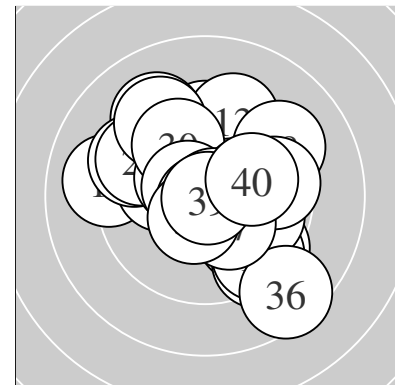

Serie 1:
 10.7 * 10.0 ↘ 9.9 ↘ 10.2 * 9.4 ↘
 9.6 ↑ 9.6 ↘ 9.9 ↘ 9.3 ↘ 9.4 ↘
 beste Teiler 53.0 (1.) 177.0 (4.) 234.0 (2.)
 Trefferlage 0.74 mm rechts, 0.46 mm tief
 Streuwert 2.16, horizontal: 2.04, vertikal: 2.29

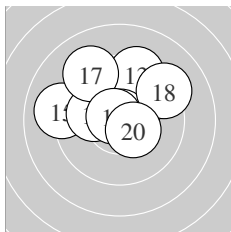

Serie 2:
 10.2 * 10.6 * 9.4 ↑ 10.8 * 9.1 ←
 10.1 ← 9.2 ↘ 9.2 ↗ 10.7 * 10.4 *
 beste Teiler 27.8 (14.) 56.3 (19.) 100.9 (12.)
 Trefferlage 0.25 mm links, 1.30 mm hoch
 Streuwert 1.97, horizontal: 2.34, vertikal: 1.51

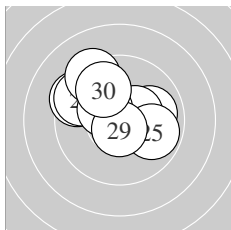

Serie 3:
 10.0 → 9.4 ↘ 10.6 * 10.4 * 9.9 →
 9.5 ↘ 9.3 ↘ 10.4 * 10.7 * 9.8 ↘
 beste Teiler 71.0 (29.) 79.7 (23.) 136.1 (24.)
 Trefferlage 0.42 mm links, 1.02 mm hoch
 Streuwert 1.81, horizontal: 2.16, vertikal: 1.38

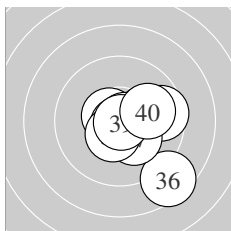

Serie 4:
 10.6 * 10.8 * 10.1 → 9.6 → 10.8 *
 8.5 ↘ 10.2 * 10.5 * 10.9 * 10.0 →
 beste Teiler 17.0 (39.) 32.6 (32.) 44.5 (35.)
 Trefferlage 1.18 mm rechts, 0.49 mm tief
 Streuwert 1.64, horizontal: 1.65, vertikal: 1.63

Unterschrift des Schützen

Ergebnis: **386** (405.1)
 Serien: 97 98 95 96
 Zähler: 26 14 0 0 0 0 0 0 0 0
 Innenzehner: 21
 weiteste: 488 (22), 467 (28), 397 (16)
 beste Teiler 11.7 (11.) 27.7 (10.) 54.7 (30.)
 Trefferlage 0.03 mm links, 0.11 mm hoch
 Streuwert 1.69, horizontal: 1.68, vertikal: 1.69

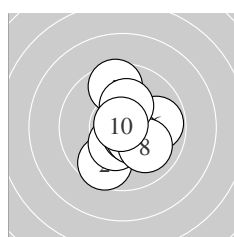
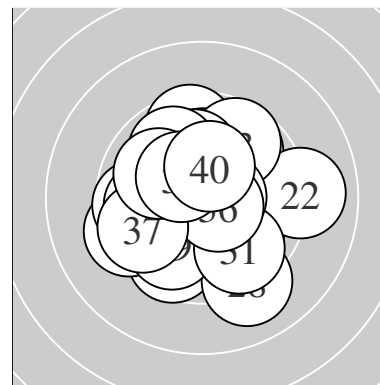

Serie 1:
 10.4 * 9.6 ↘ 10.4 * 10.6 * 9.6 ↑
 9.8 → 10.5 * 10.0 ↘ 10.2 * 10.8 *
 beste Teiler 27.7 (10.) 83.4 (4.) 116.0 (7.)
 Trefferlage 0.40 mm rechts, 0.01 mm tief
 Streuwert 1.57, horizontal: 1.24, vertikal: 1.84

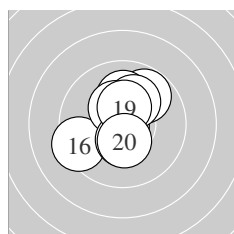

Serie 2:
 10.9 * 9.8 ↗ 10.6 * 10.1 ↑ 10.1 ↗
 9.4 ← 10.4 * 10.4 * 10.4 * 10.4 *
 beste Teiler 11.7 (11.) 81.0 (13.) 127.0 (18.)
 Trefferlage 0.12 mm links, 0.55 mm hoch
 Streuwert 1.46, horizontal: 1.39, vertikal: 1.53

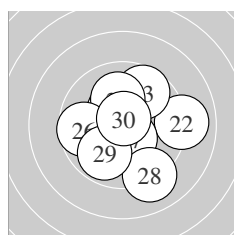

Serie 3:
 10.5 * 9.0 → 9.7 ↗ 10.4 * 10.1 ↑
 9.7 ← 10.4 * 9.1 ↘ 9.9 ↘ 10.7 *
 beste Teiler 54.7 (30.) 107.4 (21.) 127.1 (27.)
 Trefferlage 0.39 mm rechts, 0.20 mm tief
 Streuwert 2.13, horizontal: 2.20, vertikal: 2.06

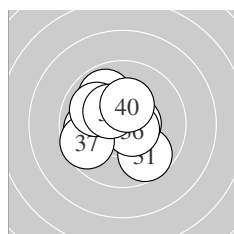

Serie 4:
 9.7 ↘ 9.9 ← 10.6 * 10.2 * 9.9 ↖
 10.6 * 9.6 ← 10.0 ↖ 10.4 * 10.3 *
 beste Teiler 90.3 (36.) 95.0 (33.) 147.7 (39.)
 Trefferlage 0.81 mm links, 0.14 mm hoch
 Streuwert 1.57, horizontal: 1.68, vertikal: 1.44

Unterschrift des Schützen

Meyton Elektronik

Ergebnis: **380** (400.0)
 Serien: 94 94 95 97
 Zähler: 23 14 3 0 0 0 0 0 0 0
 Innenzehner: 19
 weiteste: 533 (4), 521 (28), 517 (40)
 beste Teiler 43.0 (3.) 54.4 (32.) 55.5 (38.)
 Trefferlage 0.16 mm links, 0.70 mm hoch
 Streuwert 1.89, horizontal: 2.16, vertikal: 1.57

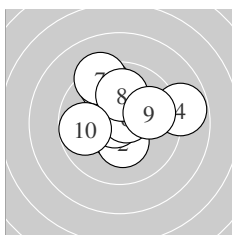
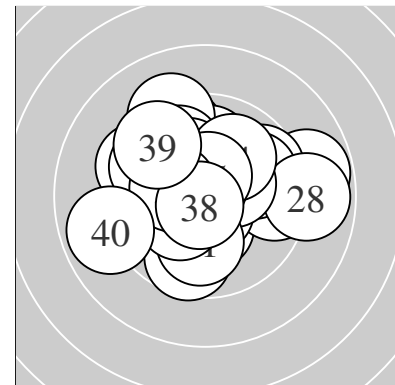

Serie 1:
 10.6 * 10.3 * 10.8 * 8.8 → 9.6 ↖
 10.6 * 9.3 ↖ 10.0 ↑ 9.9 → 9.8 ←
 beste Teiler 43.0 (3.) 80.6 (6.) 90.1 (1.)
 Trefferlage 0.22 mm rechts, 0.93 mm hoch
 Streuwert 2.04, horizontal: 2.28, vertikal: 1.77

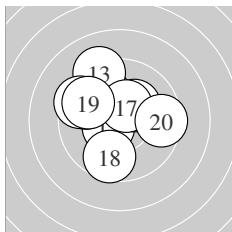

Serie 2:
 10.0 ↖ 10.5 * 9.2 ↖ 10.2 * 9.7 ↖
 9.5 ↖ 10.4 * 9.7 ↓ 9.7 ↖ 9.5 →
 beste Teiler 113.7 (12.) 132.4 (17.) 177.4 (14.)
 Trefferlage 0.83 mm links, 0.93 mm hoch
 Streuwert 2.01, horizontal: 2.13, vertikal: 1.88

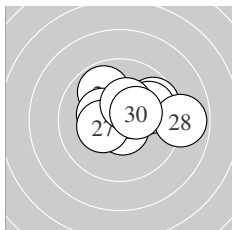

Serie 3:
 9.7 → 9.9 ↖ 10.6 * 9.9 → 10.3 *
 10.5 * 10.3 * 8.9 → 10.4 * 10.3 *
 beste Teiler 78.7 (23.) 125.9 (26.) 149.3 (29.)
 Trefferlage 0.96 mm rechts, 0.67 mm hoch
 Streuwert 1.67, horizontal: 2.16, vertikal: 0.96

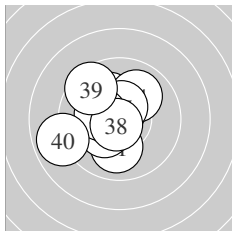

Serie 4:
 10.0 ↓ 10.7 * 10.2 * 10.0 ↗ 10.5 *
 10.3 * 10.3 * 10.7 * 9.5 ↖ 8.9 ←
 beste Teiler 54.4 (32.) 55.5 (38.) 105.2 (35.)
 Trefferlage 1.01 mm links, 0.26 mm hoch
 Streuwert 1.69, horizontal: 1.72, vertikal: 1.66

Unterschrift des Schützen

Meyton Elektronik

Ergebnis: **358** (373.0)
 Serien: 85 93 90 90
 Zähler: 14 15 6 5 0 0 0 0 0 0
 Innenzehner: 9
 weiteste: 939 (37), 923 (8), 857 (11)
 beste Teiler 51.4 (13.) 91.8 (30.) 100.4 (38.)
 Trefferlage 0.21 mm links, 1.08 mm tief
 Streuwert 3.29, horizontal: 3.65, vertikal: 2.89

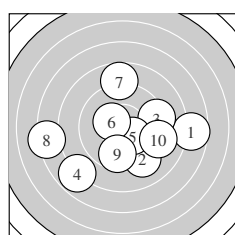
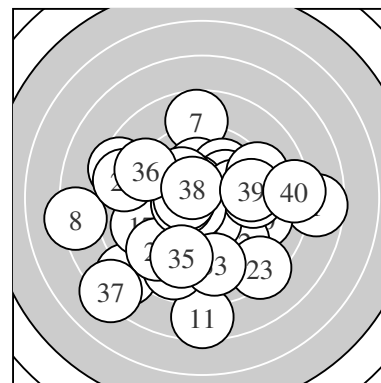

Serie 1:
 7.7 → 9.2 ↘ 9.3 → 7.8 ✓ 10.3 *
 10.4 * 8.7 ↑ 7.3 ← 9.7 ↓ 9.1 →
 beste Teiler 146.6 (6.) 159.4 (5.) 325.1 (9.)
 Trefferlage 0.32 mm rechts, 0.96 mm tief
 Streuwert 4.13, horizontal: 4.99, vertikal: 3.05

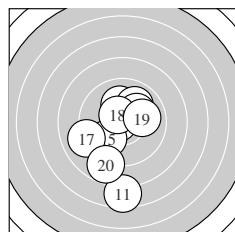

Serie 2:
 7.5 ↓ 10.1 ↑ 10.7 * 10.0 ↗ 9.9 ✓
 10.1 ↗ 9.1 ← 10.5 * 10.0 → 8.8 ↓
 beste Teiler 51.4 (13.) 105.6 (18.) 206.2 (16.)
 Trefferlage 0.41 mm links, 1.09 mm tief
 Streuwert 2.80, horizontal: 1.98, vertikal: 3.43

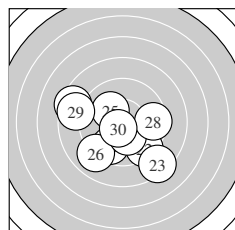

Serie 3:
 9.7 ↓ 9.3 ↘ 8.3 ↘ 8.4 ← 10.1 ↘
 9.0 ✓ 10.2 * 9.5 → 8.7 ← 10.6 *
 beste Teiler 91.8 (30.) 182.1 (27.) 202.2 (25.)
 Trefferlage 0.72 mm links, 1.22 mm tief
 Streuwert 3.06, horizontal: 3.57, vertikal: 2.43

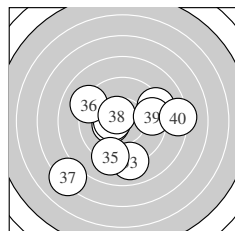

Serie 4:
 10.4 * 10.5 * 9.0 ↓ 9.2 → 9.2 ↓
 9.1 ↖ 7.2 ✓ 10.6 * 9.5 → 8.3 →
 beste Teiler 100.4 (38.) 125.2 (32.) 149.0 (31.)
 Trefferlage 0.04 mm links, 1.06 mm tief
 Streuwert 3.51, horizontal: 3.94, vertikal: 3.03

Unterschrift des Schützen

Meyton Elektronik

Ergebnis: **371** (390.6)
 Serien: 91 92 96 92
 Zähler: 15 22 2 1 0 0 0 0 0 0
 Innenzehner: 10
 weiteste: 805 (38), 615 (18), 513 (1)
 beste Teiler 86.5 (19.) 113.0 (33.) 123.1 (2.)
 Trefferlage 0.60 mm links, 0.17 mm tief
 Streuwert 2.31, horizontal: 2.67, vertikal: 1.90

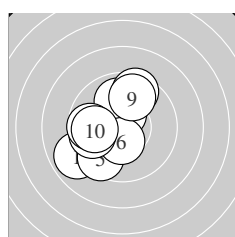
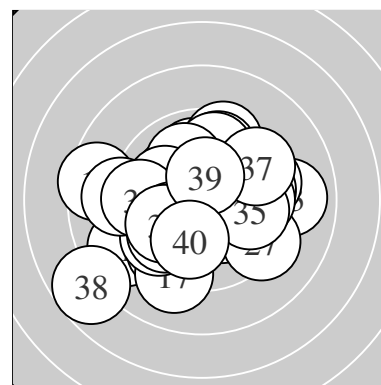

Serie 1:
 8.9 ↙ 10.5 * 9.9 ↑ 9.5 ↑ 9.5 ↘
 10.4 * 9.8 ← 9.7 ← 9.8 ↑ 9.9 ←
 beste Teiler 123.1 (2.) 133.5 (6.) 251.8 (3.)
 Trefferlage 1.35 mm links, 0.21 mm hoch
 Streuwert 2.08, horizontal: 1.91, vertikal: 2.24

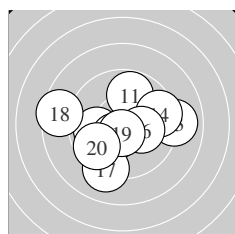

Serie 2:
 9.8 ↑ 9.9 ← 9.0 → 9.5 → 10.4 *
 10.2 * 9.1 ↓ 8.5 ← 10.6 * 9.6 ↘
 beste Teiler 86.5 (19.) 139.2 (15.) 187.9 (16.)
 Trefferlage 0.25 mm links, 0.45 mm tief
 Streuwert 2.64, horizontal: 3.20, vertikal: 1.92

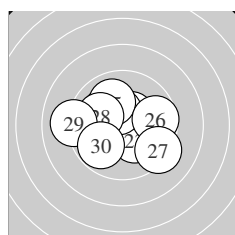

Serie 3:
 10.4 * 10.1 ↖ 10.2 * 10.4 * 10.0 ↘
 9.7 → 9.3 ↘ 10.0 ↖ 9.1 ← 9.8 ↘
 beste Teiler 127.0 (21.) 137.2 (24.) 180.4 (23.)
 Trefferlage 0.34 mm links, 0.16 mm hoch
 Streuwert 2.09, horizontal: 2.53, vertikal: 1.54

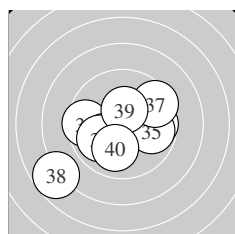

Serie 4:
 9.7 → 9.5 ← 10.5 * 10.1 ↘ 9.8 →
 9.9 ↙ 9.5 ↗ 7.7 ↙ 10.4 * 10.0 ↓
 beste Teiler 113.0 (33.) 137.1 (39.) 209.2 (34.)
 Trefferlage 0.44 mm links, 0.63 mm tief
 Streuwert 2.61, horizontal: 3.12, vertikal: 1.97

Unterschrift des Schützen

Meyton Elektronik

Ergebnis: **395** (413.5)
 Serien: 99 98 99 99
 Zähler: 35 5 0 0 0 0 0 0 0 0
 Innenzehner: 30
 weiteste: 387 (15), 334 (1), 316 (33)
 beste Teiler 8.0 (2.) 27.8 (18.) 48.2 (19.)
 Trefferlage 0.15 mm rechts, 0.00 mm
 Streuwert 1.24, horizontal: 1.40, vertikal: 1.06

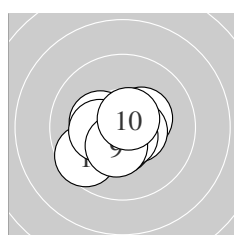
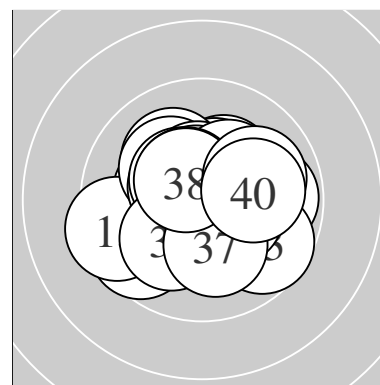

Serie 1:
 9.6 ↙ 10.9 * 10.4 * 10.5 * 10.3 *
 10.5 * 10.7 * 10.3 * 10.4 * 10.7 *
 beste Teiler 8.0 (2.) 73.2 (10.) 73.4 (7.)
 Trefferlage 0.34 mm links, 0.41 mm tief
 Streuwert 1.09, horizontal: 1.26, vertikal: 0.88

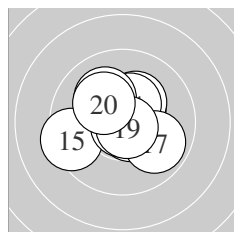

Serie 2:
 10.6 * 10.4 * 10.3 * 10.4 * 9.4 ↖
 10.1 ↘ 9.9 ↘ 10.8 * 10.8 * 10.2 *
 beste Teiler 27.8 (18.) 48.2 (19.) 81.3 (11.)
 Trefferlage 0.08 mm links, 0.28 mm hoch
 Streuwert 1.44, horizontal: 1.65, vertikal: 1.19

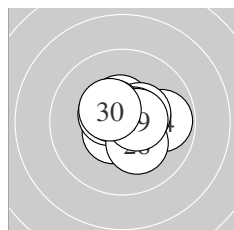

Serie 3:
 10.6 * 10.5 * 10.5 * 9.8 → 10.4 *
 10.6 * 10.5 * 10.2 * 10.5 * 10.4 *
 beste Teiler 82.8 (26.) 99.9 (21.) 103.4 (29.)
 Trefferlage 0.34 mm rechts, 0.23 mm hoch
 Streuwert 1.04, horizontal: 1.23, vertikal: 0.81

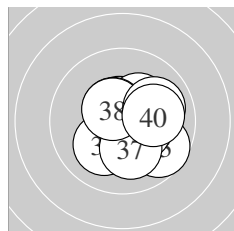

Serie 4:
 10.6 * 10.3 * 9.7 ↘ 10.5 * 10.4 *
 10.1 ↙ 10.1 ↓ 10.5 * 10.0 → 10.1 →
 beste Teiler 100.4 (31.) 110.1 (38.) 110.8 (34.)
 Trefferlage 0.71 mm rechts, 0.07 mm tief
 Streuwert 1.35, horizontal: 1.40, vertikal: 1.30

Unterschrift des Schützen

Meyton Elektronik

Ergebnis:	390	(408.8)
Serien:	98 98 97 97	
Zähler:	30 10 0 0 0 0 0 0 0 0	
Innenzehner:	24	
weiteste:	401 (10), 346 (12), 283 (35)	
beste Teiler	9.2 (8.) 53.9 (31.) 63.0 (3.)	
Trefferlage	0.21 mm rechts, 0.35 mm hoch	
Streuwert	1.40, horizontal: 1.46, vertikal: 1.35	

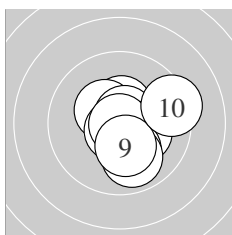
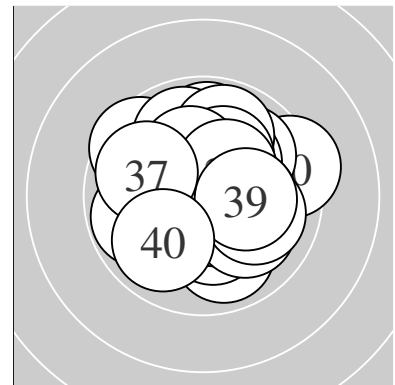

Serie 1:

10.5 *	10.4 *	10.7 *	10.3 *	10.1 ↘
10.7 *	9.9 ↘	10.9 *	10.3 *	9.3 →
beste Teiler	9.2 (8.)	63.0 (3.)	63.5 (6.)	
Trefferlage	0.66 mm rechts, 0.33 mm tief			
Streuwert	1.34, horizontal: 1.33, vertikal: 1.35			

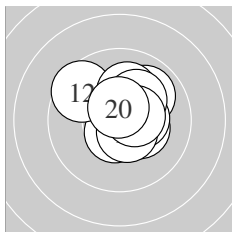

Serie 2:

10.6 *	9.6 ↖	9.9 ↗	10.3 *	10.1 ↑
10.4 *	10.2 *	10.5 *	10.5 *	10.6 *
beste Teiler	93.4 (20.)	94.3 (11.)	101.2 (18.)	
Trefferlage	0.49 mm rechts, 0.64 mm hoch			
Streuwert	1.26, horizontal: 1.34, vertikal: 1.18			

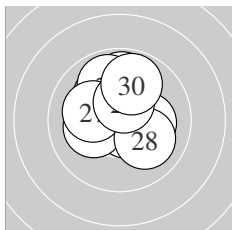

Serie 3:

10.6 *	9.8 ↑	10.1 ↖	10.2 *	9.9 ↗
10.2 *	10.1 ↖	10.0 ↘	10.4 *	9.8 ↑
beste Teiler	77.1 (21.)	133.6 (29.)	193.0 (26.)	
Trefferlage	0.02 mm links, 0.89 mm hoch			
Streuwert	1.46, horizontal: 1.41, vertikal: 1.51			

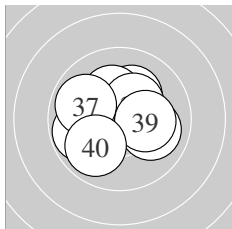

Serie 4:

10.7 *	10.2 *	10.6 *	10.2 *	9.8 ←
10.4 *	9.9 ↖	10.0 →	10.2 *	9.9 ↗
beste Teiler	53.9 (31.)	87.7 (33.)	150.8 (36.)	
Trefferlage	0.25 mm links, 0.23 mm hoch			
Streuwert	1.50, horizontal: 1.74, vertikal: 1.21			

Unterschrift des Schützen

Meyton Elektronik

Ergebnis: **383** (398.9)
 Serien: 95 95 99 94
 Zähler: 25 13 2 0 0 0 0 0 0 0
 Innenzehner: 21
 weiteste: 714 (39), 702 (12), 450 (37)
 beste Teiler 96.3 (19.) 101.2 (21.) 109.2 (29.)
 Trefferlage 1.05 mm rechts, 0.26 mm tief
 Streuwert 1.87, horizontal: 2.18, vertikal: 1.51

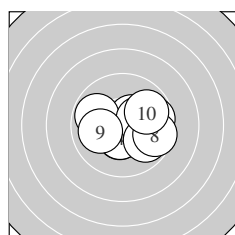
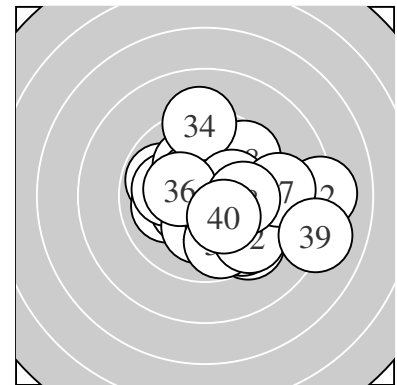

Serie 1:
 10.5 * 9.8 ↖ 10.4 * 10.5 * 10.3 *
 9.7 → 9.8 ↘ 9.6 → 10.0 ← 9.8 ↗
 beste Teiler 121.6 (1.) 125.7 (4.) 128.3 (3.)
 Trefferlage 0.81 mm rechts, 0.10 mm tief
 Streuwert 1.68, horizontal: 2.11, vertikal: 1.09

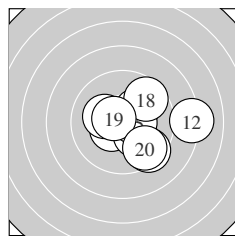

Serie 2:
 10.4 * 8.1 → 10.2 * 10.2 * 10.5 *
 10.2 * 9.4 ↘ 9.6 ↗ 10.6 * 9.6 ↘
 beste Teiler 96.3 (19.) 125.0 (15.) 132.3 (11.)
 Trefferlage 1.43 mm rechts, 0.29 mm tief
 Streuwert 2.11, horizontal: 2.51, vertikal: 1.63

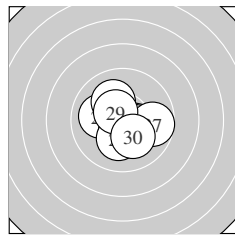

Serie 3:
 10.5 * 10.4 * 10.0 ← 10.5 * 10.1 ↖
 10.4 * 9.7 → 10.2 * 10.5 * 10.2 *
 beste Teiler 101.2 (21.) 109.2 (29.) 120.0 (24.)
 Trefferlage 0.22 mm rechts, 0.42 mm tief
 Streuwert 1.32, horizontal: 1.47, vertikal: 1.16

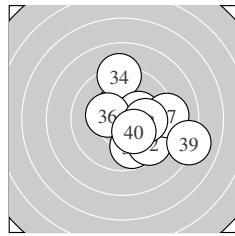

Serie 4:
 9.8 ↘ 9.5 ↘ 10.5 * 9.2 ↑ 10.3 *
 10.3 * 9.2 → 10.0 → 8.1 → 10.3 *
 beste Teiler 116.2 (33.) 157.4 (36.) 169.9 (40.)
 Trefferlage 1.74 mm rechts, 0.23 mm tief
 Streuwert 2.32, horizontal: 2.48, vertikal: 2.15

Unterschrift des Schützen

Meyton Elektronik

Ergebnis: **384** (401.8)
 Serien: 96 96 97 95
 Zähler: 24 16 0 0 0 0 0 0 0 0
 Innenzehner: 15
 weiteste: 461 (3), 419 (29), 418 (31)
 beste Teiler 51.2 (40.) 54.4 (5.) 64.8 (27.)
 Trefferlage 0.07 mm links, 0.48 mm hoch
 Streuwert 1.75, horizontal: 1.96, vertikal: 1.51

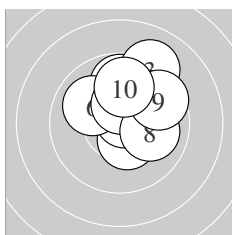
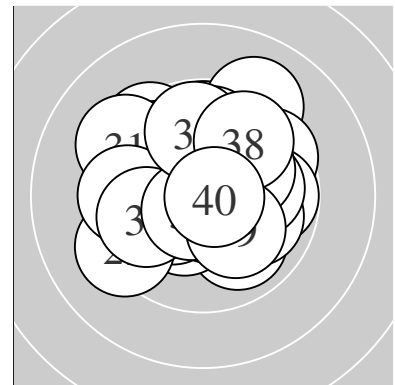

Serie 1:
 9.8 ↑ 10.4 * 9.1 ↗ 10.4 * 10.7 *
 10.0 ↘ 10.4 * 10.0 → 9.6 ↗ 9.9 ↑
 beste Teiler 54.4 (5.) 129.5 (2.) 137.3 (4.)
 Trefferlage 0.75 mm rechts, 1.37 mm hoch
 Streuwert 1.52, horizontal: 1.43, vertikal: 1.60

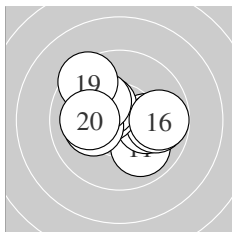

Serie 2:
 9.9 ↘ 10.2 * 9.9 → 10.5 * 10.4 *
 9.8 → 10.2 * 10.2 * 9.5 ↘ 10.1 ←
 beste Teiler 113.1 (14.) 143.0 (15.) 194.4 (18.)
 Trefferlage 0.06 mm links, 0.31 mm hoch
 Streuwert 1.75, horizontal: 2.12, vertikal: 1.29

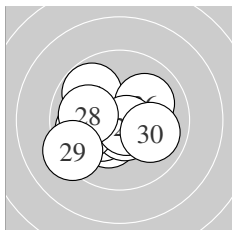

Serie 3:
 9.8 ↘ 10.3 * 10.3 * 10.6 * 9.9 ←
 10.1 ↗ 10.7 * 10.0 ← 9.3 ↙ 10.0 →
 beste Teiler 64.8 (27.) 88.5 (24.) 157.6 (22.)
 Trefferlage 0.76 mm links, 0.36 mm tief
 Streuwert 1.65, horizontal: 1.96, vertikal: 1.26

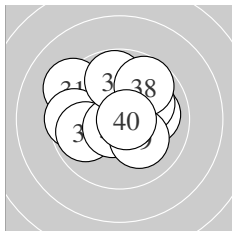

Serie 4:
 9.3 ↘ 9.6 ← 9.9 ↙ 10.0 → 10.6 *
 10.1 ↗ 9.8 ↑ 9.7 ↗ 10.1 ↘ 10.7 *
 beste Teiler 51.2 (40.) 83.0 (35.) 206.4 (39.)
 Trefferlage 0.23 mm links, 0.61 mm hoch
 Streuwert 1.91, horizontal: 2.23, vertikal: 1.52

Unterschrift des Schützen

Meyton Elektronik

Ergebnis: **378** (393.7)
 Serien: 97 98 92 91
 Zähler: 24 11 4 1 0 0 0 0 0 0
 Innenzehner: 17
 weiteste: 760 (26), 642 (1), 642 (27)
 beste Teiler 15.0 (10.) 16.1 (38.) 32.2 (28.)
 Trefferlage 0.60 mm links, 0.79 mm hoch
 Streuwert 2.24, horizontal: 2.83, vertikal: 1.43

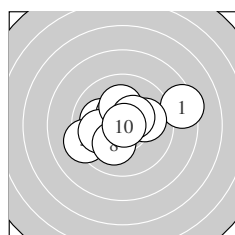
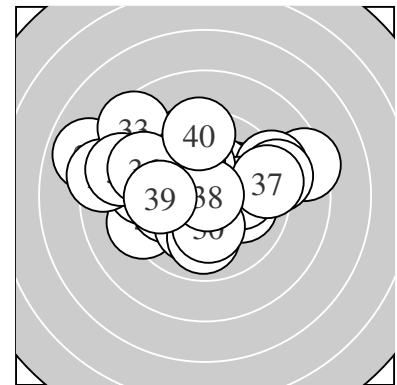

Serie 1:
 8.4 → 10.1 ← 10.5 * 9.3 ← 10.0 →
 10.0 ← 10.2 * 10.1 ↓ 10.4 * 10.9 *
 beste Teiler 15.0 (10.) 124.0 (3.) 134.8 (9.)
 Trefferlage 0.02 mm links, 0.27 mm hoch
 Streuwert 2.18, horizontal: 2.78, vertikal: 1.32

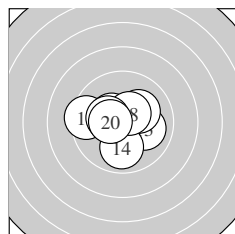

Serie 2:
 9.4 ← 10.4 * 10.0 → 9.9 ↓ 10.4 *
 10.4 * 10.2 * 10.5 * 10.3 * 10.4 *
 beste Teiler 112.0 (18.) 126.1 (20.) 133.0 (15.)
 Trefferlage 0.31 mm links, 0.11 mm hoch
 Streuwert 1.49, horizontal: 1.83, vertikal: 1.06

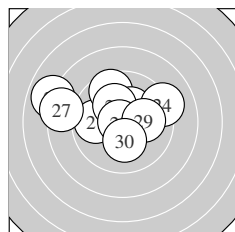

Serie 3:
 9.8 ← 9.6 ↖ 10.3 * 9.2 → 10.2 *
 7.9 ↖ 8.4 ← 10.8 * 10.1 → 10.2 *
 beste Teiler 32.2 (28.) 161.5 (23.) 189.1 (30.)
 Trefferlage 1.12 mm links, 1.02 mm hoch
 Streuwert 2.69, horizontal: 3.50, vertikal: 1.46

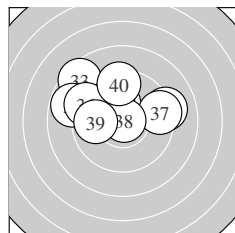

Serie 4:
 10.2 * 9.1 → 8.5 ↖ 10.0 ↖ 8.8 ↖
 9.3 ↖ 9.4 → 10.9 * 9.8 ← 9.4 ↑
 beste Teiler 16.1 (38.) 188.0 (31.) 249.3 (34.)
 Trefferlage 0.94 mm links, 1.76 mm hoch
 Streuwert 2.50, horizontal: 3.24, vertikal: 1.41

Unterschrift des Schützen

Meyton Elektronik

Ergebnis:	381	(397.5)
Serien:	95	92 96 98
Zähler:	24	13 3 0 0 0 0 0 0 0
Innenzehner:	17	
weiteste:	605 (12), 572 (11), 550 (5)	
beste Teiler	50.5 (34.) 59.0 (37.) 70.0 (36.)	
Trefferlage	0.80 mm rechts, 0.73 mm hoch	
Streuwert	1.93, horizontal: 1.91, vertikal: 1.95	

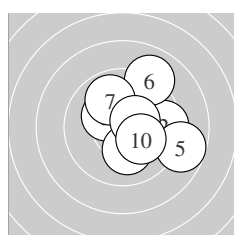
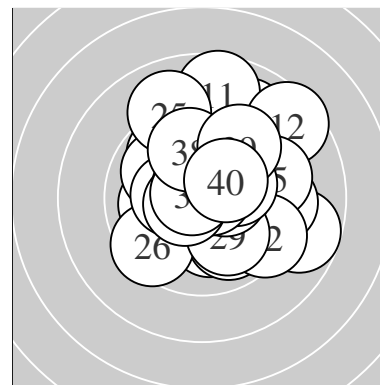

Serie 1:	10.6 *	9.5 →	10.2 *	10.2 *	8.8 →
	9.0 ↗	9.9 ↘	10.1 ↓	10.5 *	10.2 *
beste Teiler	79.6 (1.) 125.2 (9.) 176.7 (3.)				
Trefferlage	1.31 mm rechts, 0.59 mm hoch				
Streuwert	1.99, horizontal: 2.04, vertikal: 1.93				

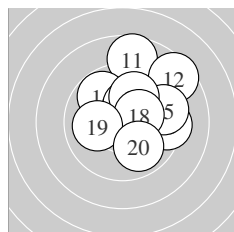

Serie 2:	8.7 ↑	8.5 ↗	9.4 →	9.8 ↘	9.4 →
	10.3 *	10.0 ↑	10.3 *	10.0 ←	9.9 ↘
beste Teiler	160.0 (16.) 161.5 (18.) 228.3 (19.)				
Trefferlage	1.33 mm rechts, 1.47 mm hoch				
Streuwert	2.26, horizontal: 2.28, vertikal: 2.24				

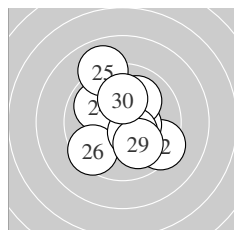

Serie 3:	10.0 ↘	9.4 ↘	10.4 *	9.9 ↘	9.0 ↗
	9.5 ↖	10.0 ↗	10.4 *	10.0 ↘	10.1 ↑
beste Teiler	126.3 (23.) 126.5 (28.) 209.0 (30.)				
Trefferlage	0.30 mm rechts, 0.06 mm hoch				
Streuwert	2.14, horizontal: 1.92, vertikal: 2.34				

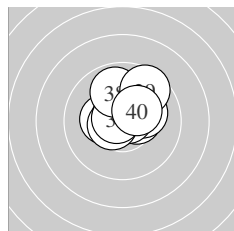

Serie 4:	10.4 *	10.2 *	10.3 *	10.8 *	10.6 *
	10.7 *	10.7 *	9.9 ↑	9.6 ↗	10.3 *
beste Teiler	50.5 (34.) 59.0 (37.) 70.0 (36.)				
Trefferlage	0.25 mm rechts, 0.80 mm hoch				
Streuwert	1.16, horizontal: 1.26, vertikal: 1.05				

Unterschrift des Schützen

Meyton Elektronik

Ergebnis: **382** (399.6)
 Serien: 99 92 96 95
 Zähler: 25 12 3 0 0 0 0 0 0 0
 Innenzehner: 19
 weiteste: 612 (17), 549 (39), 520 (11)
 beste Teiler 25.0 (8.) 47.5 (34.) 52.1 (7.)
 Trefferlage 0.59 mm rechts, 0.21 mm hoch
 Streuwert 1.97, horizontal: 2.35, vertikal: 1.50

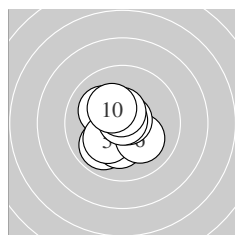
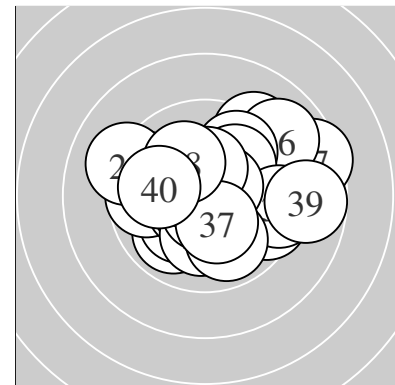

Serie 1:
 10.1 ↖ 9.9 ↗ 10.5 * 10.2 * 10.2 *
 10.1 ↘ 10.7 * 10.9 * 10.5 * 10.3 *
 beste Teiler 25.0 (8.) 52.1 (7.) 101.8 (9.)
 Trefferlage 0.45 mm links, 0.16 mm tief
 Streuwert 1.20, horizontal: 1.04, vertikal: 1.35

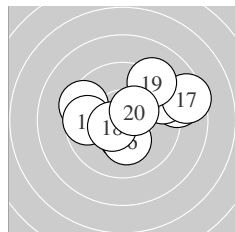

Serie 2:
 8.9 → 10.4 * 9.4 ↖ 9.3 ↗ 9.7 ←
 10.2 * 8.5 → 10.5 * 9.2 ↗ 10.4 *
 beste Teiler 110.4 (18.) 134.3 (20.) 144.1 (12.)
 Trefferlage 1.08 mm rechts, 0.72 mm hoch
 Streuwert 2.54, horizontal: 3.19, vertikal: 1.66

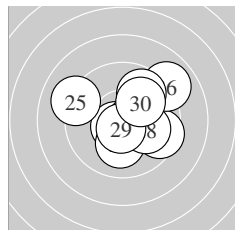

Serie 3:
 10.6 * 10.6 * 9.5 ↘ 10.1 ↓ 9.1 ↖
 9.0 ↗ 9.8 ↗ 10.0 ↘ 10.6 * 10.0 ↗
 beste Teiler 77.4 (29.) 77.8 (22.) 87.2 (21.)
 Trefferlage 0.82 mm rechts, 0.31 mm hoch
 Streuwert 2.07, horizontal: 2.35, vertikal: 1.74

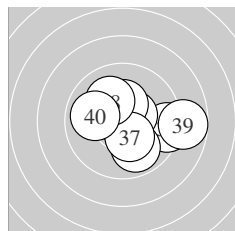

Serie 4:
 10.5 * 9.3 → 10.5 * 10.8 * 10.3 *
 9.9 ↘ 10.3 * 10.1 ↖ 8.8 → 9.9 ←
 beste Teiler 47.5 (34.) 106.1 (33.) 110.1 (31.)
 Trefferlage 0.93 mm rechts, 0.01 mm tief
 Streuwert 1.88, horizontal: 2.34, vertikal: 1.26

Unterschrift des Schützen

Meyton Elektronik

Ergebnis: **382** (396.4)
 Serien: 94 98 94 96
 Zähler: 25 12 3 0 0 0 0 0 0 0
 Innenzehner: 14
 weiteste: 639 (24), 636 (31), 613 (8)
 beste Teiler 82.0 (15.) 95.3 (30.) 99.3 (12.)
 Trefferlage 0.79 mm rechts, 0.86 mm hoch
 Streuwert 1.94, horizontal: 2.34, vertikal: 1.43

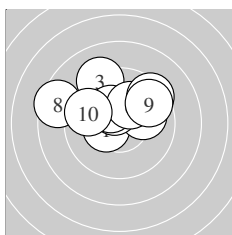
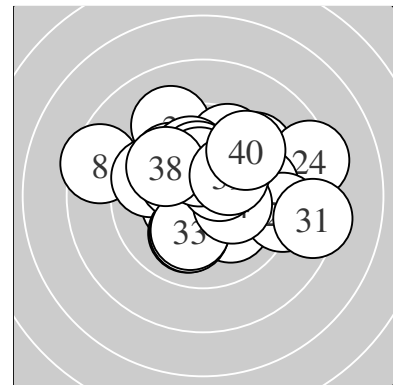

Serie 1:
 10.4 * 10.0 → 9.2 ↖ 10.5 * 10.3 *
 10.2 * 9.4 ↗ 8.5 ← 9.6 ↗ 9.7 ↖
 beste Teiler 120.0 (4.) 134.8 (1.) 157.6 (5.)
 Trefferlage 0.43 mm links, 1.56 mm hoch
 Streuwert 2.13, horizontal: 2.78, vertikal: 1.18

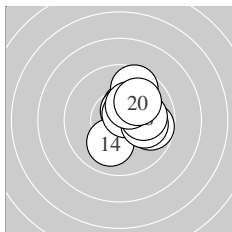

Serie 2:
 10.4 * 10.6 * 9.8 → 10.0 ↓ 10.6 *
 10.0 → 9.6 ↗ 10.0 → 10.3 * 10.0 ↗
 beste Teiler 82.0 (15.) 99.3 (12.) 145.3 (11.)
 Trefferlage 1.23 mm rechts, 0.61 mm hoch
 Streuwert 1.28, horizontal: 1.13, vertikal: 1.41

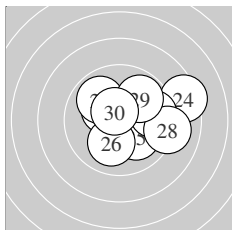

Serie 3:
 10.0 → 10.3 * 9.9 ↖ 8.4 → 10.1 ↘
 10.1 ↓ 9.7 → 9.1 → 9.8 ↗ 10.6 *
 beste Teiler 95.3 (30.) 168.3 (22.) 219.9 (25.)
 Trefferlage 1.50 mm rechts, 0.43 mm hoch
 Streuwert 2.14, horizontal: 2.63, vertikal: 1.49

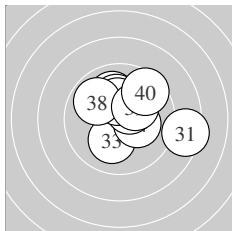

Serie 4:
 8.4 → 10.0 ↖ 10.1 ↓ 10.3 * 10.1 ↑
 10.5 * 10.3 * 9.9 ↖ 10.2 * 9.5 ↗
 beste Teiler 124.7 (36.) 166.2 (37.) 173.2 (34.)
 Trefferlage 0.86 mm rechts, 0.84 mm hoch
 Streuwert 1.98, horizontal: 2.33, vertikal: 1.56

Unterschrift des Schützen

Ergebnis: **395** (413.2)
 Serien: 98 99 99 99
 Zähler: 35 5 0 0 0 0 0 0 0 0
 Innenzehner: 31
 weiteste: 338 (5), 275 (36), 265 (27)
 beste Teiler 40.8 (16.) 58.6 (12.) 59.0 (8.)
 Trefferlage 0.07 mm links, 0.27 mm hoch
 Streuwert 1.20, horizontal: 1.15, vertikal: 1.24

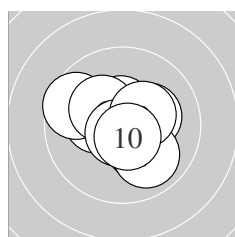
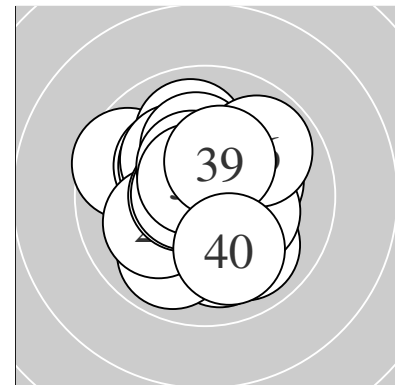

Serie 1:
 10.2 * 10.3 * 10.2 * 10.5 * 9.6 ↖
 10.2 * 9.9 ↘ 10.7 * 10.3 * 10.6 *
 beste Teiler 59.0 (8.) 83.7 (10.) 107.7 (4.)
 Trefferlage 0.04 mm links, 0.04 mm hoch
 Streuwert 1.40, horizontal: 1.61, vertikal: 1.15

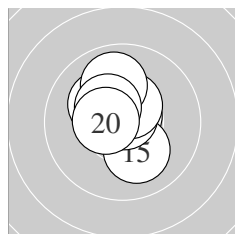

Serie 2:
 10.4 * 10.7 * 10.2 * 10.6 * 10.1 ↘
 10.8 * 10.5 * 9.9 ↑ 10.4 * 10.5 *
 beste Teiler 40.8 (16.) 58.6 (12.) 100.6 (14.)
 Trefferlage 0.33 mm links, 0.67 mm hoch
 Streuwert 0.96, horizontal: 0.80, vertikal: 1.10

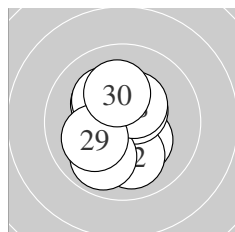

Serie 3:
 10.3 * 10.0 ↓ 10.3 * 10.2 * 10.7 *
 10.5 * 9.9 ↙ 10.4 * 10.1 ↖ 10.2 *
 beste Teiler 72.9 (25.) 111.0 (26.) 138.3 (28.)
 Trefferlage 0.28 mm links, 0.04 mm hoch
 Streuwert 1.35, horizontal: 1.07, vertikal: 1.59

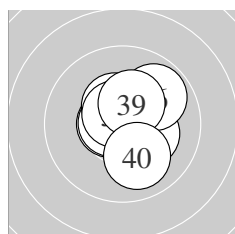

Serie 4:
 10.6 * 10.3 * 10.6 * 10.6 * 10.7 *
 9.9 ↗ 10.4 * 10.6 * 10.3 * 10.0 ↓
 beste Teiler 74.3 (35.) 83.0 (38.) 85.0 (33.)
 Trefferlage 0.35 mm rechts, 0.35 mm hoch
 Streuwert 1.09, horizontal: 1.03, vertikal: 1.14

Unterschrift des Schützen

Meyton Elektronik

Ergebnis: **369** (393.1)
 Serien: 94 89 92 94
 Zähler: 15 19 6 0 0 0 0 0 0 0
 Innenzehner: 14
 weiteste: 543 (2), 542 (6), 531 (4)
 beste Teiler 34.4 (10.) 61.0 (8.) 64.4 (19.)
 Trefferlage 0.42 mm rechts, 0.47 mm tief
 Streuwert 2.23, horizontal: 2.61, vertikal: 1.77

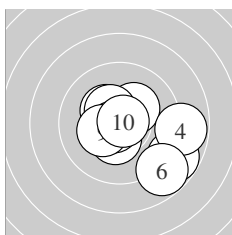
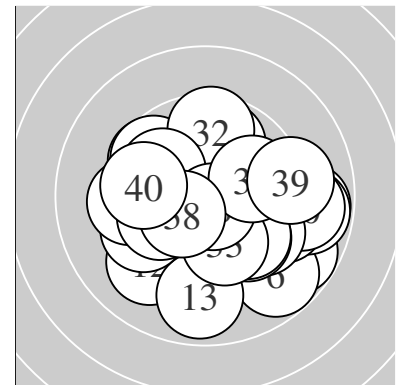

Serie 1:
 10.3 * 8.8 ↘ 10.4 * 8.8 → 10.3 *
 8.8 ↘ 10.4 * 10.7 * 10.3 * 10.8 *
 beste Teiler 34.4 (10.) 61.0 (8.) 134.4 (7.)
 Trefferlage 1.08 mm rechts, 0.61 mm tief
 Streuwert 2.16, horizontal: 2.52, vertikal: 1.74

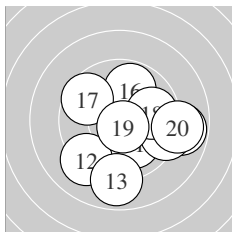

Serie 2:
 10.0 ↘ 9.2 ↙ 8.9 ↓ 8.8 → 9.3 →
 9.8 ↑ 9.6 ↘ 9.8 → 10.7 * 8.9 →
 beste Teiler 64.4 (19.) 228.5 (11.) 279.8 (16.)
 Trefferlage 1.35 mm rechts, 0.85 mm tief
 Streuwert 2.63, horizontal: 2.92, vertikal: 2.31

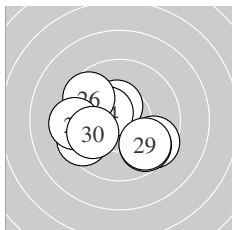

Serie 3:
 9.6 ↘ 10.5 * 9.9 ← 10.5 * 9.5 ←
 9.6 ↘ 9.7 ↘ 9.4 ← 9.8 ↘ 9.9 ←
 beste Teiler 123.5 (22.) 124.6 (24.) 255.4 (30.)
 Trefferlage 0.85 mm links, 0.60 mm tief
 Streuwert 2.04, horizontal: 2.50, vertikal: 1.45

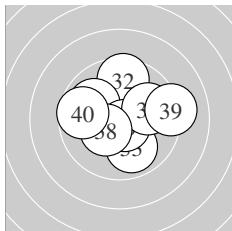

Serie 4:
 10.5 * 9.6 ↑ 9.9 ↘ 10.4 * 9.9 ↘
 10.7 * 9.9 → 10.3 * 9.2 → 9.7 ←
 beste Teiler 69.4 (36.) 106.4 (31.) 137.0 (34.)
 Trefferlage 0.11 mm rechts, 0.17 mm hoch
 Streuwert 1.94, horizontal: 2.24, vertikal: 1.58

Unterschrift des Schützen

Meyton Elektronik

Ergebnis: **381** (399.2)
 Serien: 95 97 95 94
 Zähler: 22 17 1 0 0 0 0 0 0 0
 Innenzehner: 18
 weiteste: 511 (35), 490 (8), 441 (3)
 beste Teiler 8.9 (6.) 48.0 (20.) 61.1 (7.)
 Trefferlage 0.16 mm rechts, 0.45 mm hoch
 Streuwert 1.95, horizontal: 1.99, vertikal: 1.90

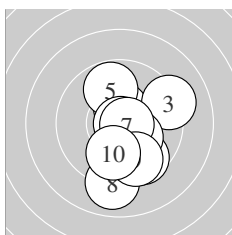
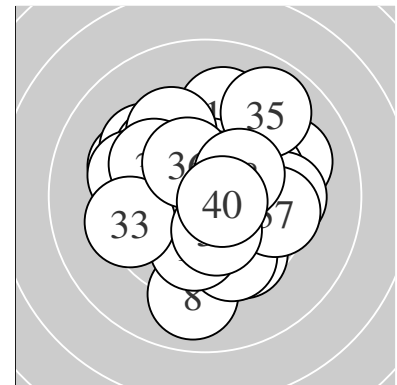

Serie 1:
 10.5 * 9.6 ↘ 9.2 → 10.2 * 9.8 ↑
 10.9 * 10.7 * 9.0 ↓ 9.7 ↘ 10.0 ↓
 beste Teiler 8.9 (6.) 61.1 (7.) 115.5 (1.)
 Trefferlage 0.75 mm rechts, 0.88 mm tief
 Streuwert 2.00, horizontal: 1.47, vertikal: 2.41

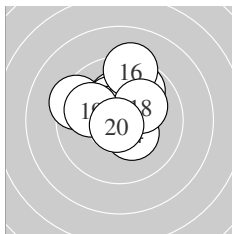

Serie 2:
 10.2 * 10.3 * 10.5 * 10.4 * 9.8 ↗
 9.3 ↑ 9.4 ↖ 10.1 ↗ 10.0 ↖ 10.8 *
 beste Teiler 48.0 (20.) 119.8 (13.) 147.8 (14.)
 Trefferlage 0.30 mm links, 1.22 mm hoch
 Streuwert 1.58, horizontal: 1.71, vertikal: 1.45

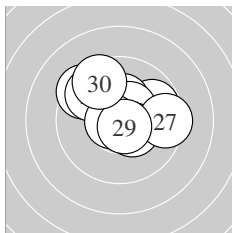

Serie 3:
 9.4 ↖ 9.8 → 10.3 * 10.5 * 10.4 *
 9.7 ↖ 9.4 → 10.7 * 10.7 * 9.5 ↖
 beste Teiler 65.1 (28.) 66.4 (29.) 123.4 (24.)
 Trefferlage 0.13 mm rechts, 0.97 mm hoch
 Streuwert 1.77, horizontal: 2.12, vertikal: 1.33

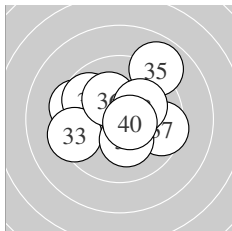

Serie 4:
 9.5 ↖ 9.8 ↖ 9.4 ← 10.2 * 8.9 ↗
 10.2 * 9.5 → 10.1 ↗ 10.2 * 10.6 *
 beste Teiler 89.4 (40.) 179.3 (39.) 185.6 (36.)
 Trefferlage 0.07 mm rechts, 0.49 mm hoch
 Streuwert 2.23, horizontal: 2.63, vertikal: 1.75

Unterschrift des Schützen

Meyton Elektronik

Ergebnis: **382** (400.8)
 Serien: 95 97 96 94
 Zähler: 23 16 1 0 0 0 0 0 0 0
 Innenzehner: 18
 weiteste: 546 (40), 438 (38), 433 (33)
 beste Teiler 73.7 (6.) 78.9 (28.) 94.0 (35.)
 Trefferlage 0.13 mm links, 0.09 mm hoch
 Streuwert 1.87, horizontal: 2.02, vertikal: 1.69

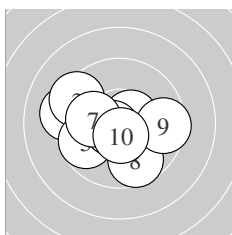
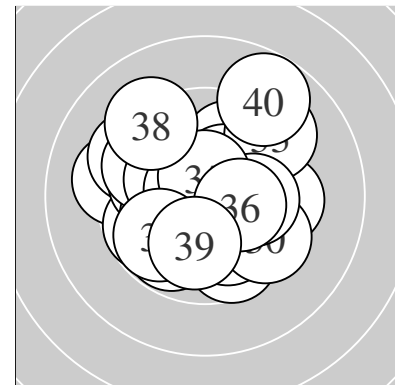

Serie 1:
 9.2 ← 10.6 * 9.4 ↘ 10.6 * 9.7 ↙
 10.7 * 10.1 ← 9.7 ↓ 9.5 → 10.6 *
 beste Teiler 73.7 (6.) 94.1 (2.) 100.4 (10.)
 Trefferlage 0.66 mm links, 0.32 mm tief
 Streuwert 1.95, horizontal: 2.42, vertikal: 1.33

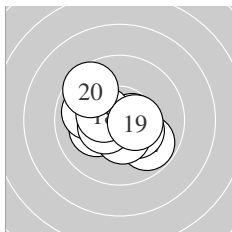

Serie 2:
 10.6 * 9.8 ↘ 10.3 * 10.2 * 9.9 ↙
 10.4 * 10.5 * 10.4 * 10.4 * 9.6 ↘
 beste Teiler 99.5 (11.) 125.5 (17.) 127.5 (19.)
 Trefferlage 0.30 mm links, 0.18 mm tief
 Streuwert 1.48, horizontal: 1.71, vertikal: 1.19

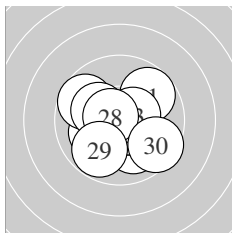

Serie 3:
 9.7 ↗ 10.0 ↓ 10.5 * 10.4 * 10.1 ↙
 9.7 ↘ 10.2 * 10.6 * 9.8 ↗ 9.5 ↘
 beste Teiler 78.9 (28.) 114.5 (23.) 140.8 (24.)
 Trefferlage 0.26 mm links, 0.19 mm tief
 Streuwert 1.77, horizontal: 1.95, vertikal: 1.56

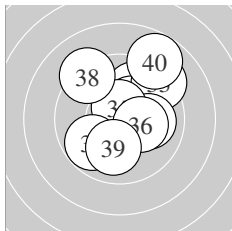

Serie 4:
 9.9 ↗ 10.3 * 9.2 ↗ 10.0 → 10.6 *
 10.3 * 9.8 ↗ 9.2 ↘ 10.0 ↓ 8.8 ↗
 beste Teiler 94.0 (35.) 155.4 (32.) 174.6 (36.)
 Trefferlage 0.67 mm rechts, 1.08 mm hoch
 Streuwert 2.16, horizontal: 2.00, vertikal: 2.31

Unterschrift des Schützen

Ergebnis: **378** (397.2)
 Serien: 95 93 97 93
 Zähler: 22 14 4 0 0 0 0 0 0 0
 Innenzehner: 19
 weiteste: 617 (16), 599 (15), 536 (38)
 beste Teiler 67.8 (33.) 68.1 (27.) 68.2 (34.)
 Trefferlage 0.76 mm links, 0.62 mm hoch
 Streuwert 2.03, horizontal: 1.99, vertikal: 2.06

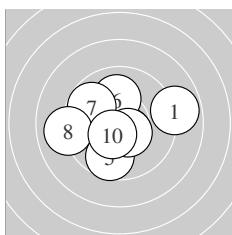
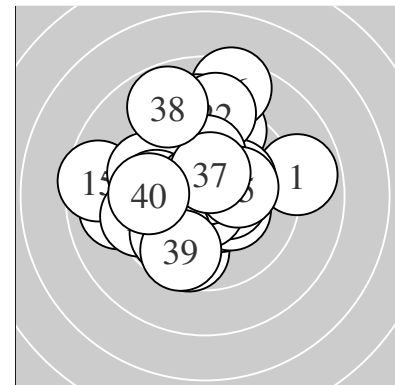

Serie 1:
 8.9 → 10.0 ↖ 10.2 * 10.5 * 9.7 ↓
 10.1 ↑ 9.8 ↖ 9.0 ← 10.5 * 10.5 *
 beste Teiler 107.0 (4.) 116.9 (9.) 123.7 (10.)
 Trefferlage 0.63 mm links, 0.05 mm hoch
 Streuwert 2.16, horizontal: 2.60, vertikal: 1.61

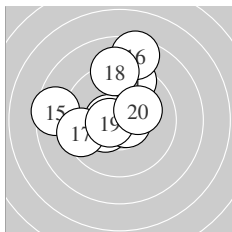

Serie 2:
 9.4 ↑ 10.4 * 10.7 * 10.6 * 8.6 ←
 8.5 ↑ 9.5 ← 9.1 ↑ 10.6 * 10.2 *
 beste Teiler 68.4 (13.) 95.0 (19.) 99.7 (14.)
 Trefferlage 0.82 mm links, 1.36 mm hoch
 Streuwert 2.43, horizontal: 2.40, vertikal: 2.46

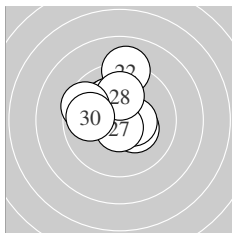

Serie 3:
 10.3 * 9.1 ↑ 10.2 * 10.5 * 10.2 *
 10.2 * 10.7 * 10.1 ↑ 9.6 ↖ 9.9 ←
 beste Teiler 68.1 (27.) 124.0 (24.) 161.1 (21.)
 Trefferlage 0.53 mm links, 1.18 mm hoch
 Streuwert 1.57, horizontal: 1.53, vertikal: 1.61

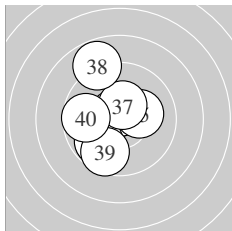

Serie 4:
 9.8 ↙ 9.9 ↙ 10.7 * 10.7 * 10.2 *
 9.8 ↙ 10.4 * 8.8 ↘ 9.6 ↓ 9.7 ←
 beste Teiler 67.8 (33.) 68.2 (34.) 132.0 (37.)
 Trefferlage 1.05 mm links, 0.10 mm tief
 Streuwert 1.94, horizontal: 1.47, vertikal: 2.31

Unterschrift des Schützen

Meyton Elektronik

Ergebnis: **375** (393.9)
 Serien: 92 96 93 94
 Zähler: 18 19 3 0 0 0 0 0 0
 Innenzehner: 13
 weiteste: 681 (2), 564 (38), 504 (22)
 beste Teiler 34.9 (14.) 39.0 (15.) 67.6 (25.)
 Trefferlage 0.27 mm links, 0.87 mm hoch
 Streuwert 2.14, horizontal: 2.26, vertikal: 2.02

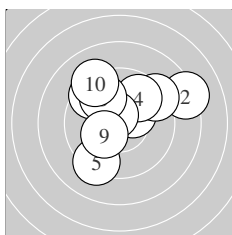
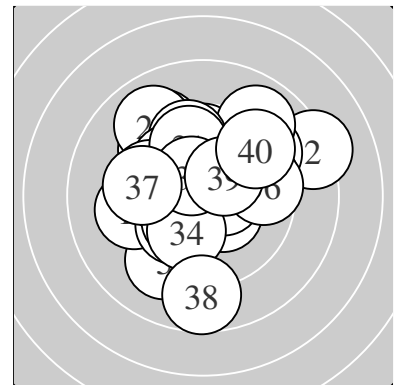

Serie 1:
 10.3 * 8.2 ↗ 9.3 ↗ 9.8 ↗ 9.2 ↘
 9.5 ↘ 10.6 * 9.8 ↘ 10.2 * 9.2 ↘
 beste Teiler 90.5 (7.) 151.1 (1.) 180.2 (9.)
 Trefferlage 0.20 mm rechts, 1.32 mm hoch
 Streuwert 2.60, horizontal: 2.93, vertikal: 2.22

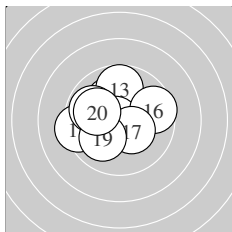

Serie 2:
 10.1 ↘ 9.4 ← 9.7 ↑ 10.8 * 10.8 *
 9.6 → 10.4 * 9.9 ↖ 10.0 ↘ 10.0 ↖
 beste Teiler 34.9 (14.) 39.0 (15.) 148.3 (17.)
 Trefferlage 0.75 mm links, 0.41 mm hoch
 Streuwert 1.73, horizontal: 2.01, vertikal: 1.40

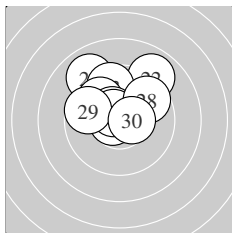

Serie 3:
 9.0 ↘ 8.9 ↗ 9.6 ↑ 9.9 ↘ 10.7 *
 10.5 * 10.6 * 9.7 ↗ 9.7 ↖ 10.5 *
 beste Teiler 67.6 (25.) 87.9 (27.) 115.8 (26.)
 Trefferlage 0.37 mm links, 1.74 mm hoch
 Streuwert 1.83, horizontal: 2.06, vertikal: 1.56

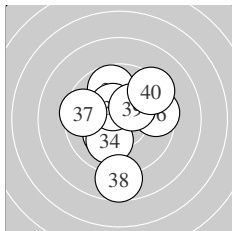

Serie 4:
 9.8 ↑ 10.1 ← 10.2 * 10.1 ↘ 10.4 *
 9.6 → 9.5 ← 8.7 ↓ 10.3 * 9.3 ↗
 beste Teiler 131.2 (35.) 164.8 (39.) 186.0 (33.)
 Trefferlage 0.17 mm links, 0.01 mm hoch
 Streuwert 2.34, horizontal: 2.17, vertikal: 2.50

Unterschrift des Schützen

Meyton Elektronik

Ergebnis: **381** (397.5)
 Serien: 92 95 98 96
 Zähler: 23 16 0 1 0 0 0 0 0 0
 Innenzehner: 16
 weiteste: 790 (3), 437 (39), 425 (35)
 beste Teiler 71.8 (27.) 101.8 (38.) 104.8 (23.)
 Trefferlage 0.23 mm links, 0.77 mm hoch
 Streuwert 1.95, horizontal: 2.14, vertikal: 1.73

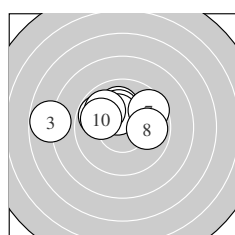
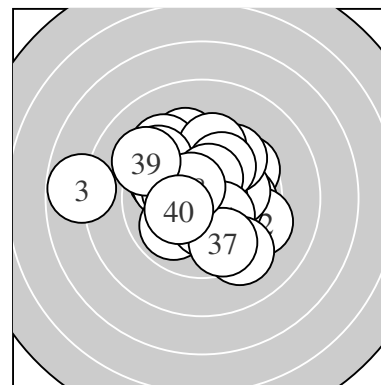

Serie 1:
 9.8 ↘ 10.1 ↘ 7.8 ← 10.1 ↑ 10.2 *
 10.4 * 9.6 ↗ 9.9 → 9.9 ↘ 9.9 ↖
 beste Teiler 149.1 (6.) 188.7 (5.) 201.5 (2.)
 Trefferlage 1.16 mm links, 1.34 mm hoch
 Streuwert 2.19, horizontal: 3.01, vertikal: 0.71

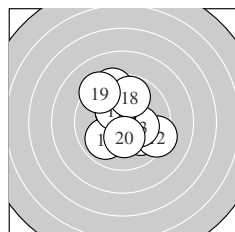

Serie 2:
 10.0 ↘ 9.3 ↘ 10.2 * 9.4 ↑ 10.4 *
 9.9 ↙ 10.3 * 9.8 ↑ 9.3 ↘ 10.3 *
 beste Teiler 134.5 (15.) 151.9 (17.) 164.1 (20.)
 Trefferlage 0.14 mm rechts, 0.52 mm hoch
 Streuwert 2.05, horizontal: 1.92, vertikal: 2.16

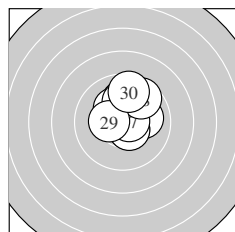

Serie 3:
 10.0 → 10.0 ↑ 10.5 * 10.2 * 10.5 *
 10.1 ↑ 10.7 * 9.6 ↗ 10.4 * 9.6 ↑
 beste Teiler 71.8 (27.) 104.8 (23.) 110.6 (25.)
 Trefferlage 0.45 mm rechts, 1.09 mm hoch
 Streuwert 1.33, horizontal: 1.15, vertikal: 1.48

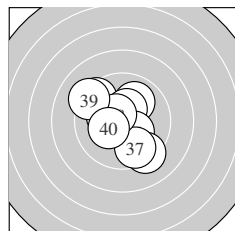

Serie 4:
 10.0 ↗ 9.4 ↘ 10.4 * 10.3 * 9.3 ↘
 10.2 * 9.7 ↘ 10.5 * 9.2 ↘ 10.3 *
 beste Teiler 101.8 (38.) 137.2 (33.) 166.9 (34.)
 Trefferlage 0.37 mm links, 0.11 mm hoch
 Streuwert 2.08, horizontal: 2.03, vertikal: 2.13

Unterschrift des Schützen

Meyton Elektronik

Ergebnis:	365	(385.7)
Serien:	88 90 93 94	
Zähler:	11 23 6 0 0 0 0 0 0 0	
Innenzehner:	7	
weiteste:	642 (10), 627 (30), 616 (17)	
beste Teiler	6.0 (39.) 123.4 (34.) 124.1 (24.)	
Trefferlage	0.06 mm links, 0.53 mm hoch	
Streuwert	2.54, horizontal: 2.84, vertikal: 2.21	

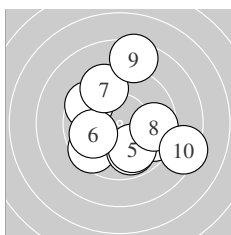
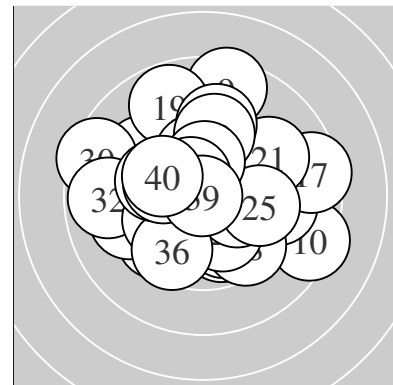

Serie 1:	9.6 ↙	9.9 ↓	9.6 ↖	9.6 →	9.9 ↓
	9.9 ←	9.5 ↕	9.7 →	8.5 ↑	8.4 →
beste Teiler	261.1 (5.) 263.3 (6.) 275.0 (2.)				
Trefferlage	0.65 mm rechts, 0.14 mm tief				
Streuwert	2.92, horizontal: 2.95, vertikal: 2.90				

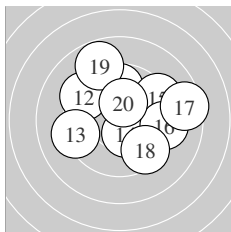

Serie 2:	9.7 ↑	9.4 ↖	9.2 ←	10.4 *	9.3 ↗
	9.3 →	8.5 →	9.5 ↓	8.8 ↕	10.3 *
beste Teiler	134.1 (14.) 165.5 (20.) 302.0 (11.)				
Trefferlage	0.76 mm rechts, 0.95 mm hoch				
Streuwert	2.86, horizontal: 3.29, vertikal: 2.36				

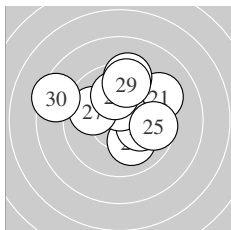

Serie 3:	9.3 ↗	10.1 ↓	10.2 *	10.5 *	9.7 →
	9.3 ↑	9.9 ←	10.0 ↑	9.6 ↑	8.4 ←
beste Teiler	124.1 (24.) 199.8 (23.) 224.2 (22.)				
Trefferlage	0.23 mm rechts, 1.29 mm hoch				
Streuwert	2.38, horizontal: 2.79, vertikal: 1.89				

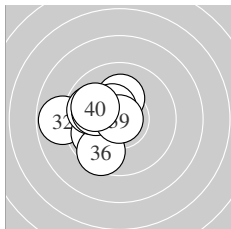

Serie 4:	10.1 ←	8.8 ←	10.2 *	10.5 *	9.9 ↙
	9.6 ↙	9.8 ←	10.0 ←	10.9 *	9.9 ↖
beste Teiler	6.0 (39.) 123.4 (34.) 192.1 (33.)				
Trefferlage	1.91 mm links, 0.03 mm hoch				
Streuwert	1.49, horizontal: 1.54, vertikal: 1.44				

Unterschrift des Schützen

Meyton Elektronik

Ergebnis: **394** (411.9)
 Serien: 98 98 100 98
 Zähler: 34 6 0 0 0 0 0 0 0 0
 Innenzehner: 29
 weiteste: 366 (39), 320 (32), 319 (4)
 beste Teiler 42.2 (17.) 55.4 (31.) 58.6 (30.)
 Trefferlage 0.10 mm links, 0.38 mm hoch
 Streuwert 1.28, horizontal: 1.50, vertikal: 1.01

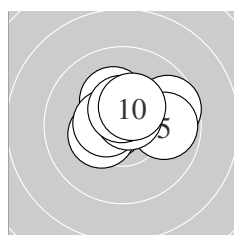
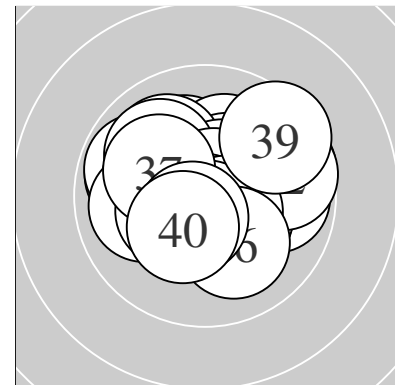

Serie 1:
 10.6 * 10.2 * 10.7 * 9.7 → 9.8 →
 10.3 * 10.5 * 10.7 * 10.5 * 10.4 *
 beste Teiler 71.2 (8.) 75.0 (3.) 85.7 (1.)
 Trefferlage 0.26 mm rechts, 0.59 mm hoch
 Streuwert 1.18, horizontal: 1.52, vertikal: 0.71

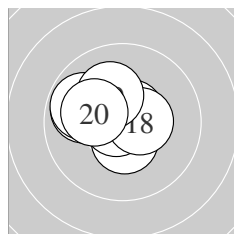

Serie 2:
 10.3 * 10.5 * 9.9 ↖ 10.6 * 9.8 ↖
 10.6 * 10.8 * 10.5 * 10.2 * 10.2 *
 beste Teiler 42.2 (17.) 78.5 (16.) 80.0 (14.)
 Trefferlage 0.77 mm links, 0.57 mm hoch
 Streuwert 1.07, horizontal: 1.26, vertikal: 0.84

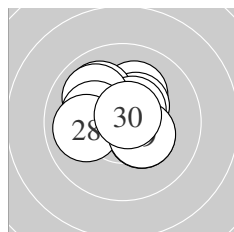

Serie 3:
 10.2 * 10.4 * 10.0 ↘ 10.3 * 10.5 *
 10.0 ↘ 10.2 * 10.0 ← 10.3 * 10.7 *
 beste Teiler 58.6 (30.) 105.2 (25.) 139.3 (22.)
 Trefferlage 0.24 mm links, 0.61 mm hoch
 Streuwert 1.27, horizontal: 1.47, vertikal: 1.03

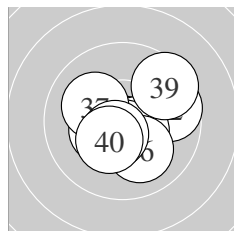

Serie 4:
 10.7 * 9.7 → 10.5 * 10.6 * 10.4 *
 10.1 ↘ 10.1 ↖ 10.6 * 9.5 ↗ 10.3 *
 beste Teiler 55.4 (31.) 82.2 (34.) 100.8 (38.)
 Trefferlage 0.33 mm rechts, 0.23 mm tief
 Streuwert 1.47, horizontal: 1.66, vertikal: 1.26

Unterschrift des Schützen

Meyton Elektronik

Ergebnis: **395** (415.2)
 Serien: 99 99 99 98
 Zähler: 35 5 0 0 0 0 0 0 0 0
 Innenzehner: 33
 weiteste: 454 (23), 339 (1), 286 (13)
 beste Teiler 19.1 (20.) 40.3 (25.) 41.4 (22.)
 Trefferlage 0.01 mm links, 0.06 mm tief
 Streuwert 1.21, horizontal: 1.37, vertikal: 1.02

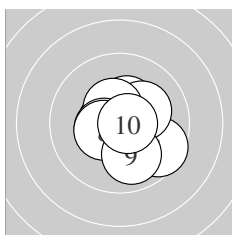
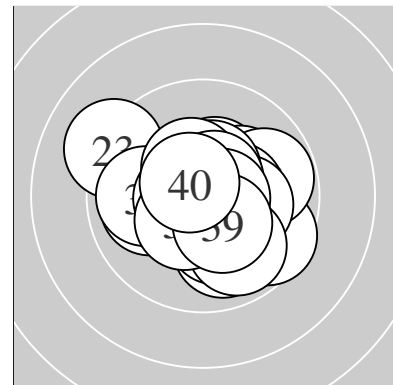

Serie 1:
 9.6 ↘ 10.4 * 10.2 * 10.6 * 10.6 *
 10.5 * 10.5 * 10.4 * 10.0 ↓ 10.7 *
 beste Teiler 60.0 (10.) 76.2 (4.) 88.4 (5.)
 Trefferlage 0.22 mm rechts, 0.11 mm tief
 Streuwert 1.27, horizontal: 1.34, vertikal: 1.20

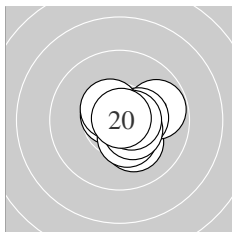

Serie 2:
 10.2 * 10.7 * 9.8 → 10.4 * 10.6 *
 10.4 * 10.5 * 10.5 * 10.6 * 10.9 *
 beste Teiler 19.1 (20.) 72.1 (12.) 80.1 (15.)
 Trefferlage 0.59 mm rechts, 0.07 mm tief
 Streuwert 0.98, horizontal: 1.09, vertikal: 0.86

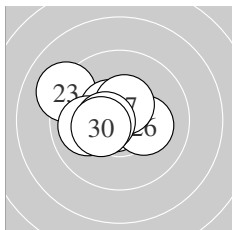

Serie 3:
 10.7 * 10.8 * 9.1 ↖ 10.5 * 10.8 *
 10.2 * 10.5 * 10.0 ← 10.5 * 10.4 *
 beste Teiler 40.3 (25.) 41.4 (22.) 73.5 (21.)
 Trefferlage 0.73 mm links, 0.34 mm hoch
 Streuwert 1.30, horizontal: 1.63, vertikal: 0.84

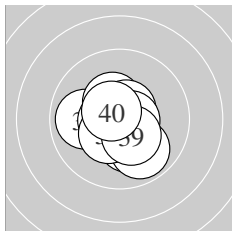

Serie 4:
 9.9 ← 10.4 * 10.6 * 10.2 * 9.9 ↓
 10.6 * 10.4 * 10.6 * 10.4 * 10.6 *
 beste Teiler 78.7 (38.) 84.6 (33.) 85.5 (40.)
 Trefferlage 0.12 mm links, 0.39 mm tief
 Streuwert 1.17, horizontal: 1.20, vertikal: 1.14

Unterschrift des Schützen

Meyton Elektronik

Ergebnis:	397	(414.2)
Serien:	99	100 98 100
Zähler:	37 3	0 0 0 0 0 0 0 0 0
Innenzehner:	32	
weiteste:	301 (24), 275 (5), 268 (27)	
beste Teiler	13.3 (38.)	65.0 (33.) 71.7 (39.)
Trefferlage	0.10 mm rechts, 0.20 mm hoch	
Streuwert	1.15, horizontal: 1.32, vertikal: 0.94	

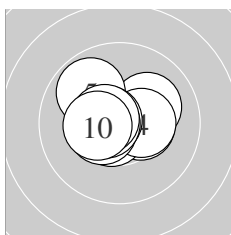
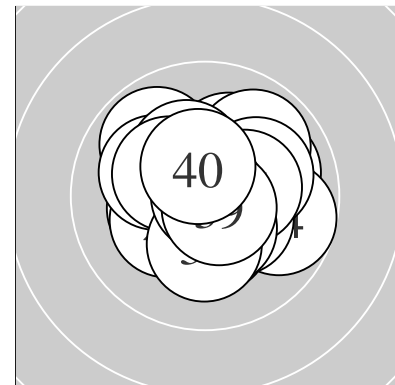

Serie 1:	10.4 *	10.6 *	10.1 ↗	10.4 *	9.9 ↖
	10.6 *	10.5 *	10.6 *	10.6 *	10.4 *
beste Teiler	77.8 (2.) 80.0 (6.) 91.0 (8.)				
Trefferlage	0.30 mm links, 0.21 mm hoch				
Streuwert	1.08, horizontal: 1.32, vertikal: 0.77				

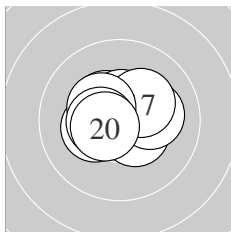

Serie 2:	10.4 *	10.4 *	10.3 *	10.7 *	10.5 *
	10.2 *	10.2 *	10.4 *	10.5 *	10.5 *
beste Teiler	74.1 (14.) 104.3 (20.) 105.6 (15.)				
Trefferlage	0.21 mm links, 0.25 mm hoch				
Streuwert	1.02, horizontal: 1.25, vertikal: 0.71				

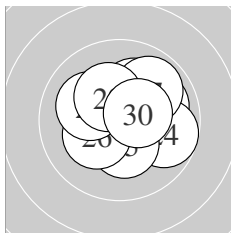

Serie 3:	10.0 →	10.1 ↗	10.4 *	9.7 →	10.3 *
	10.3 *	9.9 ↗	10.1 ↖	10.3 *	10.4 *
beste Teiler	127.2 (30.) 143.4 (23.) 157.2 (25.)				
Trefferlage	0.45 mm rechts, 0.53 mm hoch				
Streuwert	1.45, horizontal: 1.65, vertikal: 1.22				

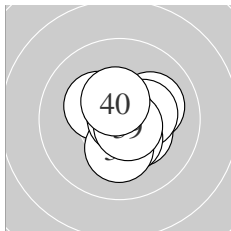

Serie 4:	10.3 *	10.1 →	10.7 *	10.4 *	10.3 *
	10.4 *	10.2 *	10.9 *	10.7 *	10.5 *
beste Teiler	13.3 (38.) 65.0 (33.) 71.7 (39.)				
Trefferlage	0.48 mm rechts, 0.16 mm tief				
Streuwert	0.98, horizontal: 0.97, vertikal: 0.99				

Unterschrift des Schützen

Ergebnis: **396** (414.0)
 Serien: 99 99 100 98
 Zähler: 36 4 0 0 0 0 0 0 0 0
 Innenzehner: 34
 weiteste: 399 (8), 365 (37), 308 (11)
 beste Teiler 36.6 (12.) 38.2 (31.) 47.5 (22.)
 Trefferlage 0.21 mm links, 0.13 mm tief
 Streuwert 1.21, horizontal: 1.36, vertikal: 1.03

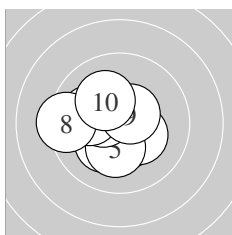
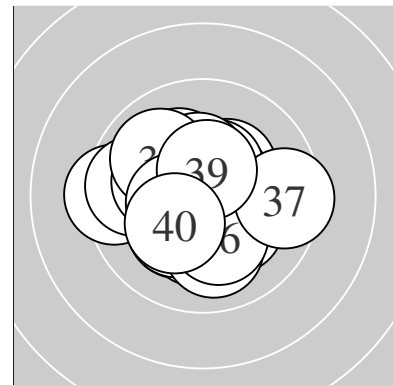

Serie 1:
 10.4 * 10.6 * 10.2 * 10.3 * 10.2 *
 10.4 * 10.0 ← 9.4 ← 10.5 * 10.2 *
 beste Teiler 95.5 (2.) 104.8 (9.) 129.0 (1.)
 Trefferlage 0.65 mm links, 0.22 mm tief
 Streuwert 1.40, horizontal: 1.64, vertikal: 1.11

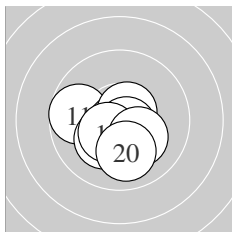

Serie 2:
 9.7 ← 10.8 * 10.6 * 10.4 * 10.6 *
 10.7 * 10.2 * 10.5 * 10.2 * 10.0 ↓
 beste Teiler 36.6 (12.) 71.4 (16.) 82.1 (15.)
 Trefferlage 0.34 mm links, 0.76 mm tief
 Streuwert 1.07, horizontal: 1.24, vertikal: 0.87

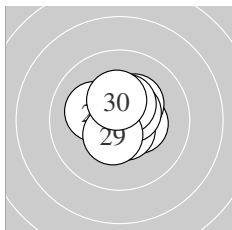

Serie 3:
 10.7 * 10.8 * 10.4 * 10.3 * 10.6 *
 10.5 * 10.2 * 10.4 * 10.5 * 10.4 *
 beste Teiler 47.5 (22.) 75.2 (21.) 86.8 (25.)
 Trefferlage 0.22 mm rechts, 0.37 mm hoch
 Streuwert 0.90, horizontal: 0.94, vertikal: 0.86

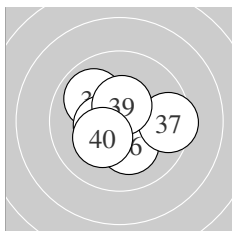

Serie 4:
 10.8 * 10.4 * 10.6 * 10.7 * 9.9 ↖
 10.2 * 9.5 → 10.5 * 10.5 * 10.2 *
 beste Teiler 38.2 (31.) 62.0 (34.) 77.3 (33.)
 Trefferlage 0.09 mm links, 0.06 mm hoch
 Streuwert 1.34, horizontal: 1.58, vertikal: 1.05

Unterschrift des Schützen

Meyton Elektronik

Ergebnis: **365** (384.5)
 Serien: 91 87 92 95
 Zähler: 16 15 7 2 0 0 0 0 0 0
 Innenzehner: 14
 weiteste: 851 (2), 816 (3), 739 (17)
 beste Teiler 36.0 (9.) 44.7 (5.) 68.4 (1.)
 Trefferlage 0.11 mm rechts, 0.47 mm hoch
 Streuwert 2.81, horizontal: 2.95, vertikal: 2.67

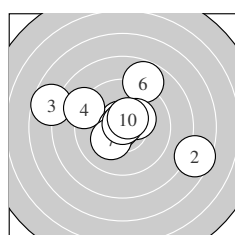
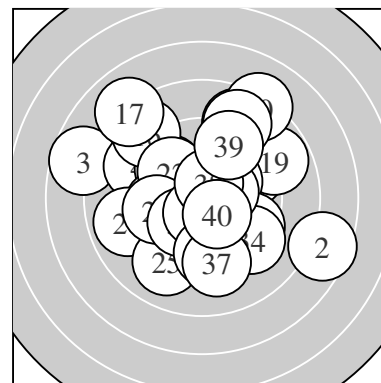

Serie 1:
 10.7 * 7.5 ↘ 7.7 ↖ 9.1 ↖ 10.8 *
 8.8 ↗ 10.2 * 10.3 * 10.8 * 10.5 *
 beste Teiler 36.0 (9.) 44.7 (5.) 68.4 (1.)
 Trefferlage 0.18 mm links, 0.77 mm hoch
 Streuwert 3.27, horizontal: 4.08, vertikal: 2.18

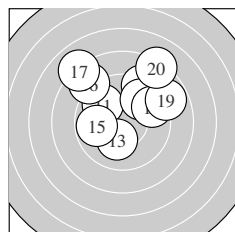

Serie 2:
 9.8 ↖ 9.1 ↗ 10.2 * 9.7 ↗ 9.8 ←
 8.7 ↖ 8.0 ↖ 9.5 ↗ 8.8 ↗ 8.2 ↗
 beste Teiler 199.5 (13.) 284.9 (15.) 288.4 (11.)
 Trefferlage 0.16 mm rechts, 2.60 mm hoch
 Streuwert 2.98, horizontal: 3.40, vertikal: 2.49

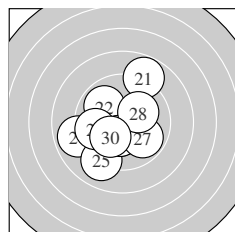

Serie 3:
 8.8 ↗ 9.9 ↖ 10.3 * 8.9 ← 9.1 ↘
 10.3 * 9.9 ↘ 10.1 ↗ 9.7 ← 10.1 ↘
 beste Teiler 153.1 (23.) 153.5 (26.) 202.2 (28.)
 Trefferlage 0.78 mm links, 0.51 mm tief
 Streuwert 2.43, horizontal: 2.38, vertikal: 2.47

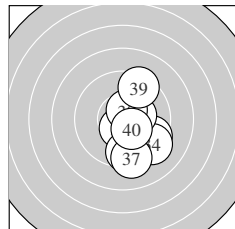

Serie 4:
 10.6 * 10.5 * 9.5 ↘ 9.3 ↘ 10.3 *
 9.5 ↓ 9.2 ↓ 10.5 * 9.4 ↗ 10.4 *
 beste Teiler 77.7 (31.) 101.8 (32.) 107.8 (38.)
 Trefferlage 1.28 mm rechts, 0.95 mm tief
 Streuwert 1.82, horizontal: 1.16, vertikal: 2.31

Unterschrift des Schützen

Meyton Elektronik

Ergebnis: **391** (408.2)
 Serien: 96 97 100 98
 Zähler: 31 9 0 0 0 0 0 0 0 0
 Innenzehner: 25
 weiteste: 442 (13), 371 (32), 337 (15)
 beste Teiler 16.2 (19.) 65.8 (9.) 84.2 (20.)
 Trefferlage 0.34 mm links, 0.54 mm hoch
 Streuwert 1.41, horizontal: 1.71, vertikal: 1.02

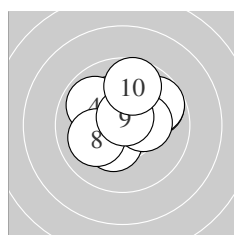
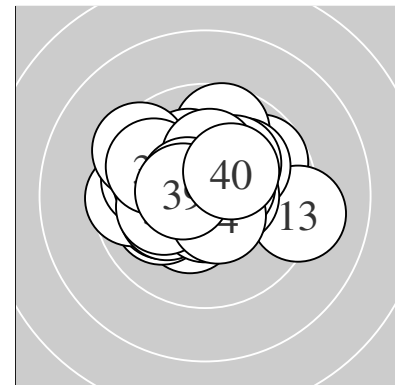

Serie 1:
 9.8 ↗ 10.5 * 10.2 * 9.9 ↘ 10.3 *
 9.7 ↗ 10.3 * 10.1 ↙ 10.7 * 9.7 ↑
 beste Teiler 65.8 (9.) 109.0 (2.) 154.3 (5.)
 Trefferlage 0.11 mm rechts, 0.84 mm hoch
 Streuwert 1.53, horizontal: 1.73, vertikal: 1.31

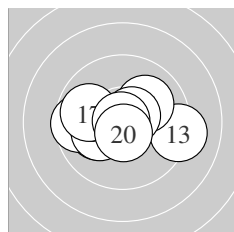

Serie 2:
 10.1 ↙ 10.1 ← 9.2 → 10.1 ↗ 9.6 ←
 10.2 * 9.9 ↙ 10.6 * 10.9 * 10.6 *
 beste Teiler 16.2 (19.) 84.2 (20.) 87.4 (18.)
 Trefferlage 0.50 mm links, 0.09 mm tief
 Streuwert 1.75, horizontal: 2.35, vertikal: 0.78

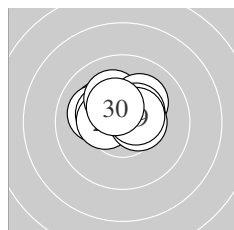

Serie 3:
 10.2 * 10.1 ↘ 10.3 * 10.4 * 10.2 *
 10.1 ↗ 10.4 * 10.5 * 10.5 * 10.4 *
 beste Teiler 113.7 (29.) 122.0 (28.) 132.0 (27.)
 Trefferlage 0.32 mm links, 0.82 mm hoch
 Streuwert 1.03, horizontal: 1.34, vertikal: 0.58

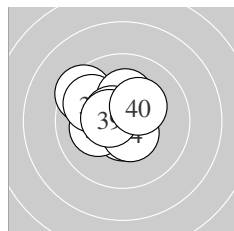

Serie 4:
 10.6 * 9.5 ↘ 10.2 * 10.5 * 9.8 ↘
 10.4 * 10.2 * 10.6 * 10.5 * 10.3 *
 beste Teiler 86.0 (31.) 96.0 (38.) 105.1 (39.)
 Trefferlage 0.65 mm links, 0.61 mm hoch
 Streuwert 1.28, horizontal: 1.43, vertikal: 1.11

Unterschrift des Schützen

Meyton Elektronik

Ergebnis:	366	(383.7)
Serien:	88 92 95 91	
Zähler:	12 22 6 0 0 0 0 0 0 0	
Innenzehner:	7	
weiteste:	648 (14), 573 (7), 567 (36)	
beste Teiler	93.6 (25.) 124.3 (32.) 131.1 (26.)	
Trefferlage	0.31 mm links, 0.09 mm tief	
Streuwert	2.62, horizontal: 2.86, vertikal: 2.36	

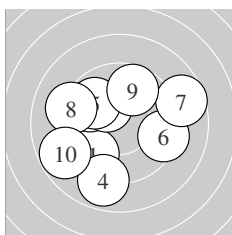
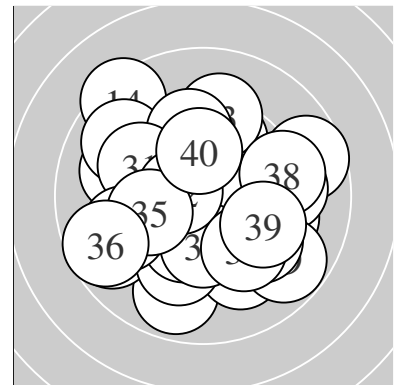

Serie 1:	9.5 ↙	9.8 ↘	10.2 *	8.9 ↓	9.8 ↘
	9.4 →	8.7 →	9.2 ←	9.7 ↑	8.8 ←
beste Teiler	184.2 (3.) 277.3 (5.) 297.9 (2.)				
Trefferlage	0.81 mm links, 0.05 mm tief				
Streuwert	2.98, horizontal: 3.31, vertikal: 2.61				

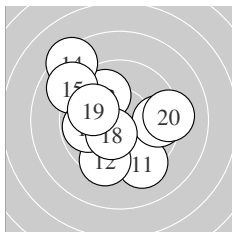

Serie 2:	9.3 ↘	9.5 ↓	10.0 ↘	8.4 ↘	9.0 ↘
	9.8 ←	9.6 →	10.4 *	10.0 ↘	9.2 →
beste Teiler	139.0 (18.) 246.9 (19.) 250.9 (13.)				
Trefferlage	0.70 mm links, 0.22 mm hoch				
Streuwert	2.83, horizontal: 2.97, vertikal: 2.69				

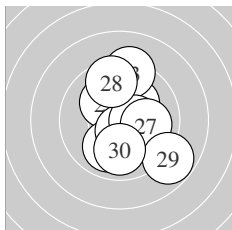

Serie 3:	10.2 *	10.2 *	9.3 ↑	10.0 ↓	10.6 *
	10.4 *	10.0 →	9.6 ↑	8.8 ↘	9.9 ↓
beste Teiler	93.6 (25.) 131.1 (26.) 190.7 (21.)				
Trefferlage	0.70 mm rechts, 0.09 mm hoch				
Streuwert	2.13, horizontal: 1.67, vertikal: 2.51				

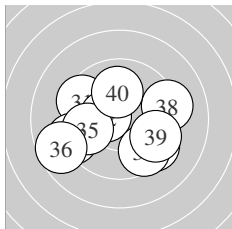

Serie 4:	9.5 ↘	10.5 *	9.4 ↘	9.2 ←	9.8 ←
	8.7 ←	9.6 ↘	9.2 →	9.6 ↘	10.0 ↑
beste Teiler	124.3 (32.) 235.8 (40.) 291.9 (35.)				
Trefferlage	0.42 mm links, 0.63 mm tief				
Streuwert	2.71, horizontal: 3.36, vertikal: 1.84				

Unterschrift des Schützen

Meyton Elektronik

Ergebnis: **387** (407.2)

Serien: 96 97 97 97

Zähler: 27 13 0 0 0 0 0 0 0 0

Innenzehner: 23

weiteste: 461 (34), 458 (18), 398 (7)

beste Teiler 12.6 (38.) 32.2 (33.) 33.0 (35.)

Trefferlage 0.31 mm links, 0.23 mm tief

Streuwert 1.56, horizontal: 1.82, vertikal: 1.26

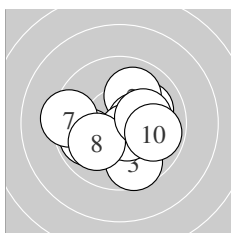
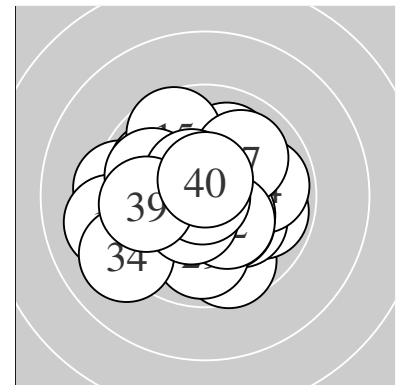

Serie 1:

10.1 ↗	10.0 ↗	9.7 ↓	10.4 *	9.9 ←
10.6 *	9.4 ←	10.0 ↖	10.2 *	9.9 →

beste Teiler 93.0 (6.) 130.7 (4.) 190.3 (9.)

Trefferlage 0.22 mm rechts, 0.29 mm tief

Streuwert 1.86, horizontal: 2.19, vertikal: 1.45

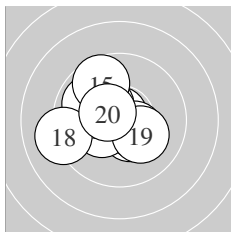

Serie 2:

10.8 *	10.4 *	10.3 *	9.9 ↖	9.7 ↖
10.4 *	10.3 *	9.1 ←	10.2 *	10.5 *

beste Teiler 39.8 (11.) 112.3 (20.) 129.4 (12.)

Trefferlage 0.80 mm links, 0.14 mm hoch

Streuwert 1.59, horizontal: 1.80, vertikal: 1.35

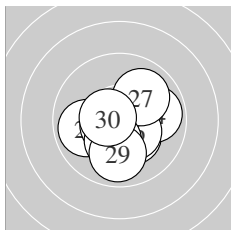

Serie 3:

10.3 *	10.3 *	9.9 ←	9.9 →	10.6 *
10.4 *	10.0 ↗	10.3 *	9.9 ↓	10.6 *

beste Teiler 95.1 (30.) 97.0 (25.) 138.4 (26.)

Trefferlage 0.30 mm rechts, 0.48 mm tief

Streuwert 1.41, horizontal: 1.59, vertikal: 1.22

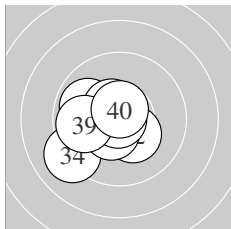

Serie 4:

9.9 ↖	10.3 *	10.8 *	9.1 ↖	10.8 *
10.5 *	10.5 *	10.9 *	9.8 ←	10.6 *

beste Teiler 12.6 (38.) 32.2 (33.) 33.0 (35.)

Trefferlage 0.99 mm links, 0.28 mm tief

Streuwert 1.32, horizontal: 1.48, vertikal: 1.13

Unterschrift des Schützen