

Ergebnis: **376** (395.1)
 Serien: 96 94 92 94
 Zähler: 18 20 2 0 0 0 0 0 0 0
 Innenzehner: 15
 weiteste: 610 (25), 501 (28), 494 (7)
 beste Teiler 21.0 (29.) 35.5 (18.) 52.6 (14.)
 Trefferlage 0.25 mm links, 0.02 mm tief
 Streuwert 2.18, horizontal: 2.85, vertikal: 1.19

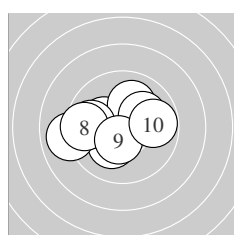

Serie 1:
 10.2 * 10.2 * 10.7 * 10.0 ↗ 10.1 ↗
 9.8 ← 9.0 ← 9.5 ← 10.5 * 9.8 →
 beste Teiler 64.8 (3.) 123.6 (9.) 182.4 (2.)
 Trefferlage 0.83 mm links, 0.10 mm hoch
 Streuwert 1.91, horizontal: 2.47, vertikal: 1.10

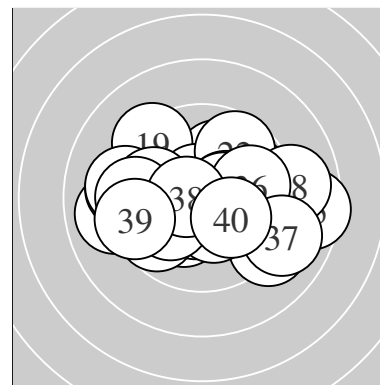
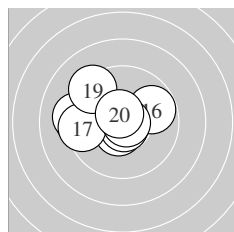

Serie 2:
 9.4 ← 10.6 * 9.8 ↖ 10.7 * 9.2 ←
 9.8 → 9.4 ← 10.8 * 9.3 ↘ 10.6 *
 beste Teiler 35.5 (18.) 52.6 (14.) 82.2 (20.)
 Trefferlage 1.49 mm links, 0.46 mm hoch
 Streuwert 1.83, horizontal: 2.32, vertikal: 1.15

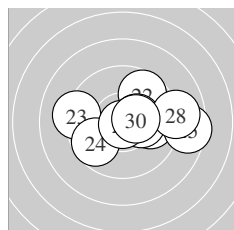

Serie 3:
 9.9 → 9.7 ↗ 9.2 ← 9.7 ↙ 8.5 →
 10.4 * 10.3 * 8.9 → 10.9 * 10.4 *
 beste Teiler 21.0 (29.) 126.6 (30.) 138.3 (26.)
 Trefferlage 1.29 mm rechts, 0.15 mm hoch
 Streuwert 2.33, horizontal: 3.09, vertikal: 1.14

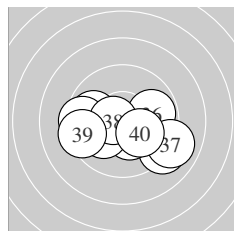

Serie 4:
 9.1 ↘ 9.8 ← 10.3 * 9.5 ← 10.1 ↙
 9.8 → 9.0 ↘ 10.6 * 9.4 ← 10.2 *
 beste Teiler 87.2 (38.) 152.5 (33.) 195.8 (40.)
 Trefferlage 0.03 mm rechts, 0.83 mm tief
 Streuwert 2.29, horizontal: 3.04, vertikal: 1.14

Unterschrift des Schützen

Meyton Elektronik

Ergebnis: **386** (403.0)
 Serien: 97 96 98 95
 Zähler: 27 12 1 0 0 0 0 0 0 0
 Innenzehner: 20
 weiteste: 558 (18), 477 (34), 449 (30)
 beste Teiler 15.6 (9.) 34.8 (3.) 69.3 (26.)
 Trefferlage 0.12 mm links, 0.44 mm tief
 Streuwert 1.77, horizontal: 1.93, vertikal: 1.59

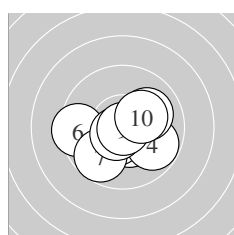
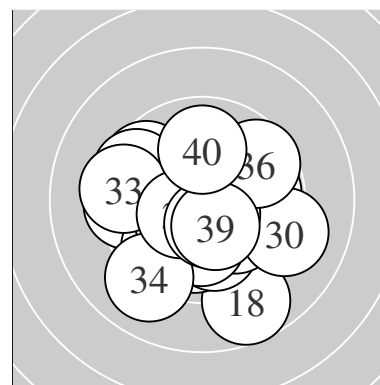

Serie 1:
 10.4 * 10.5 * 10.8 * 9.8 ↘ 10.0 ↗
 9.4 ← 9.7 ↙ 10.6 * 10.9 * 10.2 *
 beste Teiler 15.6 (9.) 34.8 (3.) 77.8 (8.)
 Trefferlage 0.02 mm rechts, 0.52 mm tief
 Streuwert 1.52, horizontal: 1.88, vertikal: 1.04

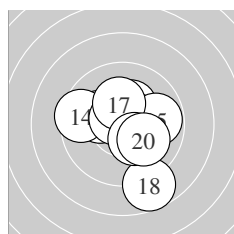

Serie 2:
 10.3 * 10.5 * 10.1 ↖ 9.5 ← 9.8 →
 10.6 * 10.2 * 8.7 ↓ 10.3 * 10.1 ↘
 beste Teiler 77.6 (16.) 119.2 (12.) 160.8 (19.)
 Trefferlage 0.32 mm rechts, 0.18 mm tief
 Streuwert 1.97, horizontal: 1.95, vertikal: 2.00

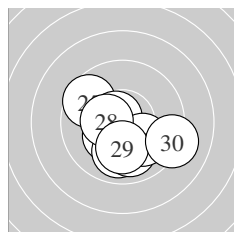

Serie 3:
 10.3 * 10.0 ↓ 10.6 * 10.0 ↓ 9.6 ↖
 10.7 * 10.0 ↘ 10.4 * 10.1 ↓ 9.2 ↗
 beste Teiler 69.3 (26.) 98.8 (23.) 135.5 (28.)
 Trefferlage 0.08 mm links, 0.88 mm tief
 Streuwert 1.69, horizontal: 1.93, vertikal: 1.42

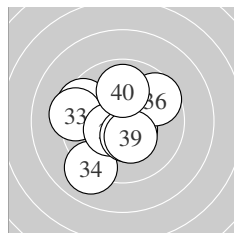

Serie 4:
 9.5 ↖ 10.6 * 9.3 ← 9.0 ↙ 10.5 *
 9.6 ↗ 10.4 * 10.5 * 10.4 * 9.9 ↑
 beste Teiler 98.2 (32.) 101.1 (35.) 125.1 (38.)
 Trefferlage 0.75 mm links, 0.18 mm tief
 Streuwert 1.98, horizontal: 2.09, vertikal: 1.87

Unterschrift des Schützen

Meyton Elektronik

Ergebnis: **392** (409.7)
 Serien: 98 99 100 95
 Zähler: 33 6 1 0 0 0 0 0 0 0
 Innenzehner: 26
 weiteste: 568 (31), 345 (1), 303 (9)
 beste Teiler 6.0 (23.) 18.3 (29.) 44.2 (14.)
 Trefferlage 0.33 mm rechts, 0.28 mm hoch
 Streuwert 1.43, horizontal: 1.51, vertikal: 1.35

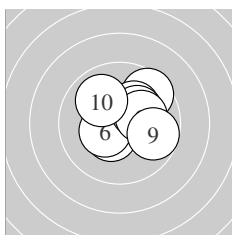
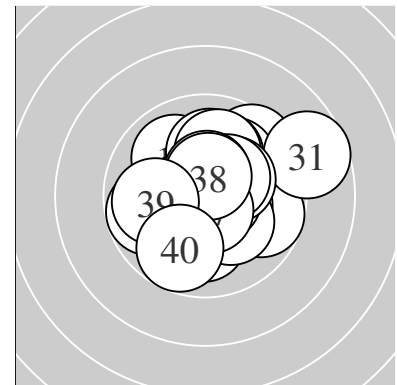

Serie 1:
 9.6 ↗ 10.4 * 10.5 * 10.4 * 10.2 *
 10.4 * 10.2 * 10.2 * 9.7 → 10.0 ↘
 beste Teiler 111.7 (3.) 127.8 (2.) 141.8 (6.)
 Trefferlage 0.70 mm rechts, 0.59 mm hoch
 Streuwert 1.42, horizontal: 1.62, vertikal: 1.20

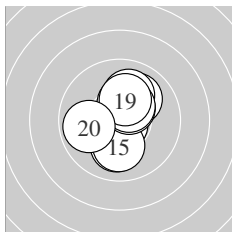

Serie 2:
 10.1 ↓ 10.0 ↗ 10.4 * 10.8 * 10.1 ↓
 10.0 ↑ 10.4 * 10.4 * 10.2 * 9.9 ←
 beste Teiler 44.2 (14.) 130.8 (17.) 144.7 (18.)
 Trefferlage 0.18 mm rechts, 0.40 mm hoch
 Streuwert 1.40, horizontal: 1.11, vertikal: 1.64

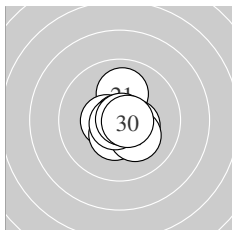

Serie 3:
 10.0 ↑ 10.5 * 10.9 * 10.4 * 10.5 *
 10.4 * 10.2 * 10.8 * 10.9 * 10.7 *
 beste Teiler 6.0 (23.) 18.3 (29.) 49.0 (28.)
 Trefferlage 0.22 mm rechts, 0.22 mm tief
 Streuwert 0.90, horizontal: 0.77, vertikal: 1.02

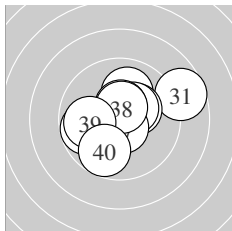

Serie 4:
 8.7 → 10.0 ↑ 9.8 ← 10.3 * 10.4 *
 10.5 * 10.6 * 10.5 * 9.9 ← 9.8 ↙
 beste Teiler 76.2 (37.) 102.2 (38.) 112.4 (36.)
 Trefferlage 0.22 mm rechts, 0.37 mm hoch
 Streuwert 1.94, horizontal: 2.30, vertikal: 1.51

Unterschrift des Schützen

Ergebnis: **385** (401.0)
 Serien: 98 96 96 95
 Zähler: 25 15 0 0 0 0 0 0 0 0
 Innenzehner: 15
 weiteste: 471 (36), 455 (20), 431 (13)
 beste Teiler 36.2 (5.) 56.2 (9.) 86.0 (2.)
 Trefferlage 0.03 mm rechts, 0.43 mm hoch
 Streuwert 1.79, horizontal: 1.95, vertikal: 1.62

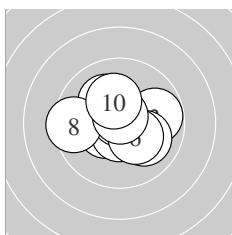
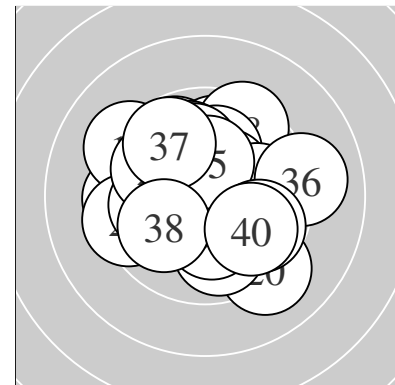

Serie 1:
 10.4 * 10.6 * 9.8 → 10.0 ↘ 10.8 *
 10.3 * 10.1 ↖ 9.5 ← 10.7 * 10.2 *
 beste Teiler 36.2 (5.) 56.2 (9.) 86.0 (2.)
 Trefferlage 0.03 mm links, 0.11 mm hoch
 Streuwert 1.50, horizontal: 1.83, vertikal: 1.08

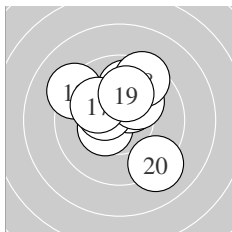

Serie 2:
 10.4 * 10.4 * 9.2 ↘ 9.9 ↑ 10.4 *
 10.1 ↗ 10.1 ↘ 9.5 ↑ 10.1 ↑ 9.1 ↘
 beste Teiler 132.0 (11.) 134.1 (15.) 145.3 (12.)
 Trefferlage 0.01 mm rechts, 1.07 mm hoch
 Streuwert 1.94, horizontal: 1.93, vertikal: 1.95

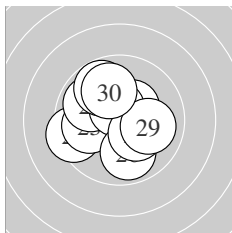

Serie 3:
 10.4 * 9.4 ← 10.0 ← 9.9 ↘ 10.6 *
 9.9 ↓ 10.3 * 9.8 ↖ 10.0 → 10.0 ↑
 beste Teiler 94.5 (25.) 140.7 (21.) 169.2 (27.)
 Trefferlage 0.56 mm links, 0.24 mm hoch
 Streuwert 1.79, horizontal: 1.92, vertikal: 1.66

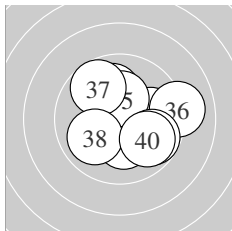

Serie 4:
 9.9 → 10.2 * 10.2 * 10.0 ↑ 10.3 *
 9.1 → 9.7 ↘ 10.0 ↗ 9.8 ↘ 9.9 ↘
 beste Teiler 164.5 (35.) 183.0 (33.) 196.4 (32.)
 Trefferlage 0.73 mm rechts, 0.29 mm hoch
 Streuwert 1.97, horizontal: 2.17, vertikal: 1.74

Unterschrift des Schützen

Meyton Elektronik

Ergebnis: **378** (395.6)
 Serien: 90 95 97 96
 Zähler: 23 15 1 0 0 1 0 0 0 0
 Innenzehner: 13
 weiteste: 1299 (3), 520 (2), 446 (15)
 beste Teiler 22.8 (34.) 25.0 (32.) 56.0 (4.)
 Trefferlage 0.26 mm rechts, 0.40 mm hoch
 Streuwert 2.37, horizontal: 2.92, vertikal: 1.64

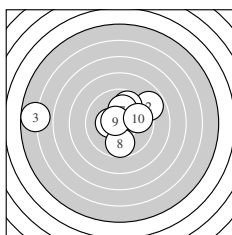
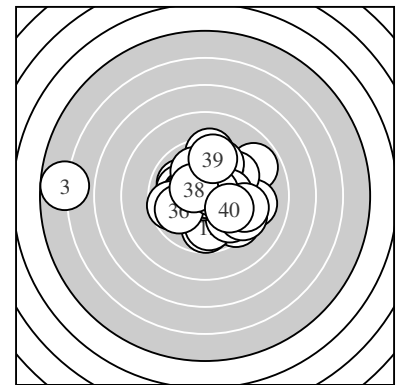

Serie 1:
 10.4 * 8.9 ↗ 5.8 ← 10.7 * 10.1 ↗
 9.8 ↗ 10.1 ↑ 9.7 ↓ 10.7 * 9.8 →
 beste Teiler 56.0 (4.) 74.3 (9.) 149.0 (1.)
 Trefferlage 0.44 mm links, 0.84 mm hoch
 Streuwert 3.54, horizontal: 4.72, vertikal: 1.64

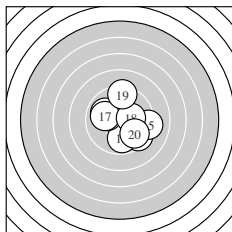

Serie 2:
 9.4 ↘ 10.5 * 9.8 ↓ 10.2 * 9.2 →
 10.0 ↖ 10.0 ← 10.2 * 9.4 ↑ 9.7 ↘
 beste Teiler 103.2 (12.) 177.4 (18.) 198.2 (14.)
 Trefferlage 0.64 mm rechts, 0.05 mm tief
 Streuwert 2.15, horizontal: 2.26, vertikal: 2.03

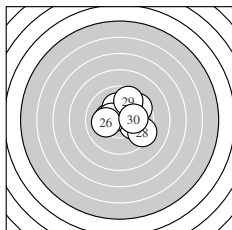

Serie 3:
 10.3 * 10.0 → 10.2 * 10.0 → 10.4 *
 10.1 ← 9.6 ↗ 9.4 ↘ 9.7 ↑ 10.1 →
 beste Teiler 126.2 (25.) 165.7 (21.) 198.1 (23.)
 Trefferlage 0.87 mm rechts, 0.54 mm hoch
 Streuwert 1.75, horizontal: 2.03, vertikal: 1.42

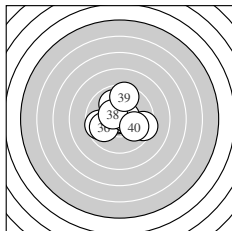

Serie 4:
 9.4 → 10.9 * 10.0 ↖ 10.9 * 9.7 ←
 9.9 ← 10.6 * 10.4 * 9.6 ↑ 10.0 ↘
 beste Teiler 22.8 (34.) 25.0 (32.) 91.3 (37.)
 Trefferlage 0.02 mm links, 0.26 mm hoch
 Streuwert 1.80, horizontal: 2.03, vertikal: 1.55

Unterschrift des Schützen

Meyton Elektronik

Ergebnis: **371** (389.3)
 Serien: 93 88 97 93
 Zähler: 17 18 4 1 0 0 0 0 0 0
 Innenzehner: 15
 weiteste: 856 (16), 566 (17), 559 (18)
 beste Teiler 56.0 (12.) 61.2 (36.) 73.1 (10.)
 Trefferlage 0.62 mm links, 0.32 mm hoch
 Streuwert 2.47, horizontal: 2.61, vertikal: 2.32

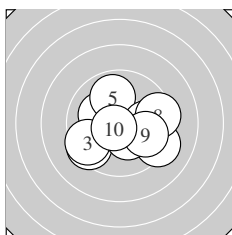
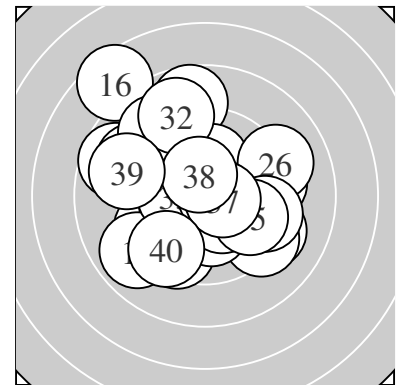

Serie 1:
 9.4 ↙ 10.1 ↖ 9.5 ↙ 9.2 ↘ 9.9 ↑
 9.9 → 10.3 * 9.4 → 9.8 ↘ 10.7 *
 beste Teiler 73.1 (10.) 160.0 (7.) 202.7 (2.)
 Trefferlage 0.43 mm rechts, 0.51 mm tief
 Streuwert 2.18, horizontal: 2.67, vertikal: 1.55

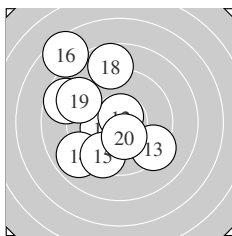

Serie 2:
 10.3 * 10.7 * 9.3 ↘ 8.9 ↙ 9.5 ↙
 7.5 ↘ 8.7 ↖ 8.7 ↑ 9.1 ↖ 10.4 *
 beste Teiler 56.0 (12.) 149.9 (20.) 175.9 (11.)
 Trefferlage 1.89 mm links, 0.59 mm hoch
 Streuwert 3.17, horizontal: 2.79, vertikal: 3.51

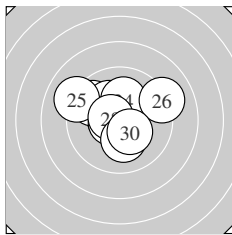

Serie 3:
 10.6 * 9.7 ↖ 10.2 * 10.1 ↑ 9.1 ↖
 9.1 → 10.6 * 10.6 * 10.2 * 10.3 *
 beste Teiler 88.8 (27.) 91.0 (28.) 98.7 (21.)
 Trefferlage 0.46 mm links, 0.64 mm hoch
 Streuwert 1.88, horizontal: 2.24, vertikal: 1.44

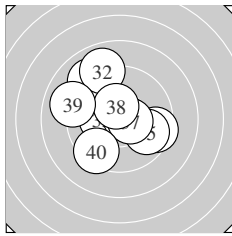

Serie 4:
 9.1 ↖ 8.9 ↑ 10.2 * 9.5 → 9.8 ↘
 10.7 * 10.5 * 10.4 * 9.0 ↖ 9.4 ↙
 beste Teiler 61.2 (36.) 107.0 (37.) 130.7 (38.)
 Trefferlage 0.58 mm links, 0.55 mm hoch
 Streuwert 2.46, horizontal: 2.57, vertikal: 2.35

Unterschrift des Schützen

Ergebnis: **396** (410.1)
 Serien: 99 99 99 99
 Zähler: 36 4 0 0 0 0 0 0 0 0
 Innenzehner: 29
 weiteste: 316 (30), 309 (1), 308 (16)
 beste Teiler 50.1 (11.) 52.1 (5.) 81.8 (13.)
 Trefferlage 0.27 mm links, 0.01 mm hoch
 Streuwert 1.32, horizontal: 1.37, vertikal: 1.26

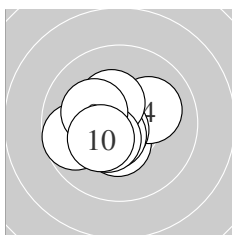
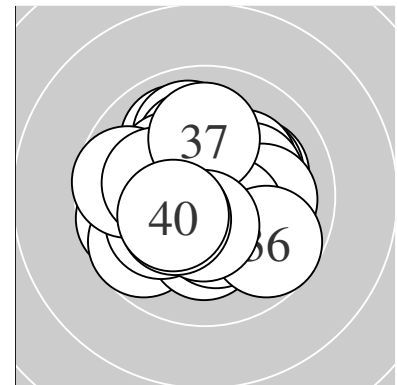

Serie 1:
 9.7 ← 10.4 * 10.5 * 10.1 → 10.7 *
 10.6 * 10.4 * 10.4 * 10.2 * 10.3 *
 beste Teiler 52.1 (5.) 93.5 (6.) 118.1 (3.)
 Trefferlage 0.66 mm links, 0.15 mm tief
 Streuwert 1.15, horizontal: 1.25, vertikal: 1.03

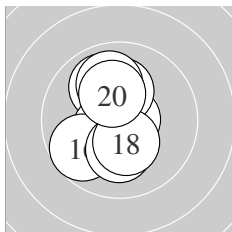

Serie 2:
 10.8 * 10.0 ↗ 10.6 * 10.5 * 10.2 *
 9.7 ← 10.2 * 10.3 * 10.0 ↗ 10.2 *
 beste Teiler 50.1 (11.) 81.8 (13.) 104.1 (14.)
 Trefferlage 0.52 mm links, 0.19 mm hoch
 Streuwert 1.38, horizontal: 0.88, vertikal: 1.74

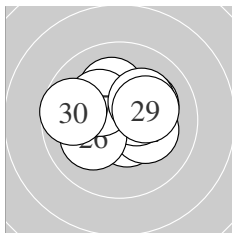

Serie 3:
 10.5 * 10.2 * 10.2 * 10.5 * 10.1 ↗
 10.1 ← 10.2 * 10.2 * 10.2 * 9.7 ←
 beste Teiler 102.9 (21.) 125.2 (24.) 177.2 (27.)
 Trefferlage 0.15 mm rechts, 0.44 mm hoch
 Streuwert 1.43, horizontal: 1.75, vertikal: 1.01

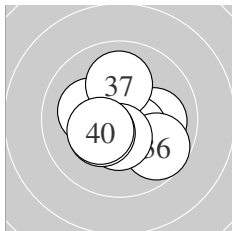

Serie 4:
 10.4 * 10.5 * 10.0 → 10.2 * 10.5 *
 9.7 ↘ 10.0 ↑ 10.5 * 10.3 * 10.3 *
 beste Teiler 114.0 (35.) 118.8 (32.) 120.1 (38.)
 Trefferlage 0.07 mm links, 0.42 mm tief
 Streuwert 1.35, horizontal: 1.52, vertikal: 1.15

Unterschrift des Schützen

Ergebnis: **371** (389.7)

Serien: 91 91 96 93

Zähler: 16 20 3 1 0 0 0 0 0 0

Innenzehner: 16

weiteste: 777 (1), 560 (20), 556 (14)

beste Teiler 32.2 (18.) 69.0 (19.) 96.3 (30.)

Trefferlage 0.33 mm links, 0.40 mm tief

Streuwert 2.45, horizontal: 2.46, vertikal: 2.44

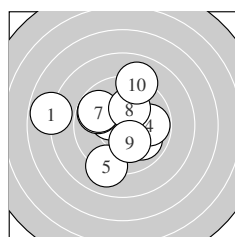
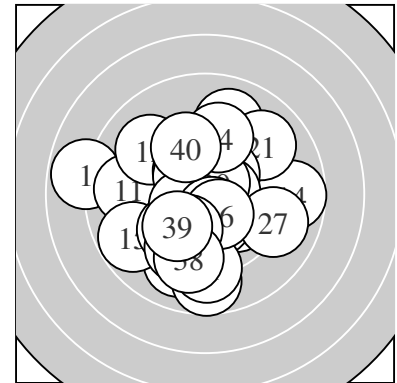

Serie 1:

7.8 ←	10.4 *	9.9 ↘	9.8 →	9.1 ↓
9.8 ↙	9.8 ↘	10.2 *	10.2 *	9.0 ↑

beste Teiler 146.6 (2.) 191.1 (9.) 194.6 (8.)

Trefferlage 0.79 mm links, 0.34 mm hoch

Streuwert 2.78, horizontal: 3.10, vertikal: 2.43

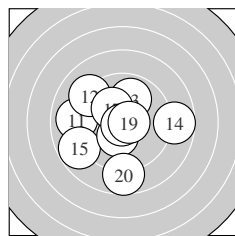

Serie 2:

9.0 ←	9.1 ↘	9.9 ↑	8.7 →	8.8 ↙
10.3 *	10.2 *	10.8 *	10.7 *	8.7 ↓

beste Teiler 32.2 (18.) 69.0 (19.) 155.9 (16.)

Trefferlage 0.76 mm links, 0.31 mm tief

Streuwert 2.82, horizontal: 3.09, vertikal: 2.51

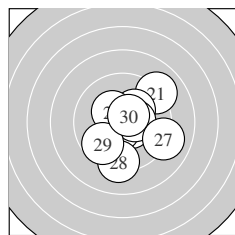

Serie 3:

9.0 ↗	10.5 *	10.2 *	10.6 *	10.4 *
10.3 *	9.1 ↘	9.3 ↓	9.7 ↙	10.6 *

beste Teiler 96.3 (30.) 98.8 (24.) 105.6 (22.)

Trefferlage 0.80 mm rechts, 0.34 mm tief

Streuwert 2.06, horizontal: 2.02, vertikal: 2.10

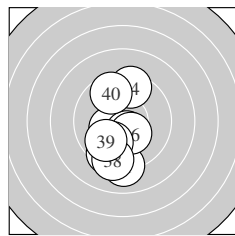

Serie 4:

9.0 ↓	9.4 ↓	10.3 *	9.5 ↑	10.5 *
10.3 *	9.9 ↓	9.3 ↓	9.9 ↙	9.7 ↘

beste Teiler 122.4 (35.) 155.2 (33.) 157.8 (36.)

Trefferlage 0.59 mm links, 1.32 mm tief

Streuwert 2.10, horizontal: 1.05, vertikal: 2.77

Unterschrift des Schützen

Meyton Elektronik

Ergebnis: **388** (406.2)
 Serien: 96 97 97 98
 Zähler: 28 12 0 0 0 0 0 0 0 0
 Innenzehner: 19
 weiteste: 446 (28), 342 (18), 340 (16)
 beste Teiler 9.8 (22.) 34.0 (39.) 46.0 (32.)
 Trefferlage 0.16 mm rechts, 0.11 mm tief
 Streuwert 1.57, horizontal: 1.76, vertikal: 1.35

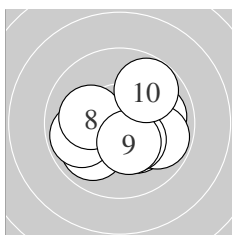
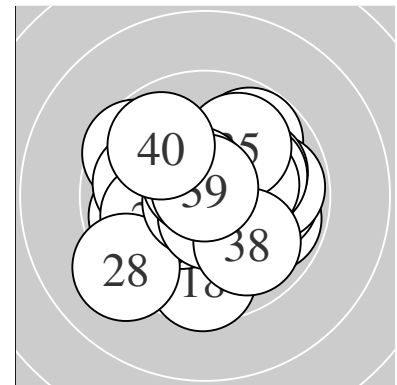

Serie 1:
 10.3 * 10.0 → 9.9 ↙ 10.7 * 9.8 →
 9.8 ← 10.3 * 10.1 ← 10.4 * 9.8 ↗
 beste Teiler 60.8 (4.) 148.0 (9.) 153.0 (7.)
 Trefferlage 0.27 mm rechts, 0.43 mm tief
 Streuwert 1.60, horizontal: 1.92, vertikal: 1.21

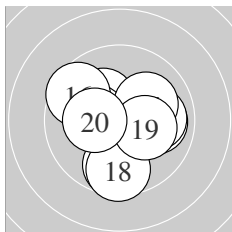

Serie 2:
 10.2 * 10.0 → 10.2 * 10.0 → 9.7 ↓
 9.6 ↖ 10.1 ↗ 9.6 ↓ 10.2 * 10.3 *
 beste Teiler 174.0 (20.) 177.0 (13.) 178.9 (11.)
 Trefferlage 0.05 mm rechts, 0.25 mm tief
 Streuwert 1.86, horizontal: 1.96, vertikal: 1.75

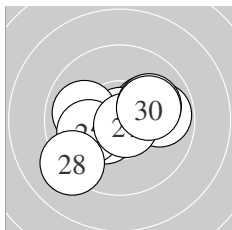

Serie 3:
 10.2 * 10.9 * 10.4 * 9.9 ← 10.0 ←
 9.8 → 10.7 * 9.2 ↙ 10.0 → 10.1 →
 beste Teiler 9.8 (22.) 56.0 (27.) 128.6 (23.)
 Trefferlage 0.02 mm rechts, 0.13 mm tief
 Streuwert 1.75, horizontal: 2.16, vertikal: 1.20

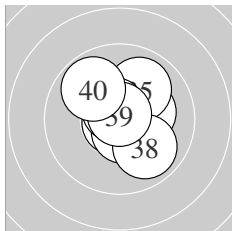

Serie 4:
 10.5 * 10.8 * 10.8 * 10.2 * 10.0 ↗
 10.6 * 10.6 * 9.9 ↘ 10.8 * 9.8 ↖
 beste Teiler 34.0 (39.) 46.0 (32.) 48.5 (33.)
 Trefferlage 0.30 mm rechts, 0.38 mm hoch
 Streuwert 1.17, horizontal: 1.10, vertikal: 1.23

Unterschrift des Schützen

Meyton Elektronik

Ergebnis:	361	(381.0)
Serien:	92 93 90 86	
Zähler:	10 22 7 1 0 0 0 0 0 0	
Innenzehner:	8	
weiteste:	895 (35), 659 (38), 652 (26)	
beste Teiler	37.5 (20.) 43.4 (32.) 114.1 (8.)	
Trefferlage	0.06 mm links, 0.51 mm hoch	
Streuwert	2.84, horizontal: 3.61, vertikal: 1.75	

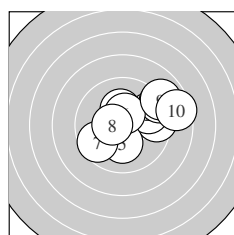
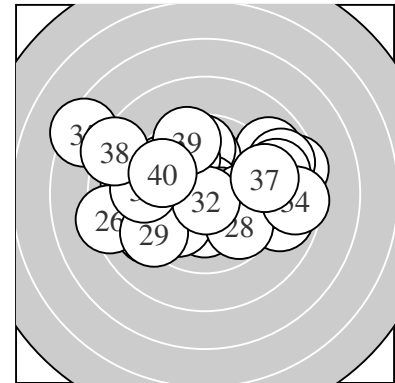

Serie 1:	9.4 →	9.7 ↗	9.1 ↗	10.3 *	10.2 *
	10.4 *	9.6 ↙	10.5 *	8.9 ↗	8.5 →
beste Teiler	114.1 (8.)	130.2 (6.)	175.6 (4.)		
Trefferlage	1.68 mm rechts, 0.79 mm hoch				
Streuwert	2.31, horizontal: 2.83, vertikal: 1.64				

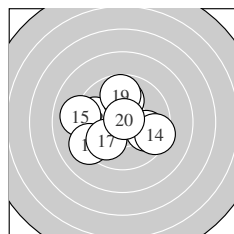

Serie 2:	10.0 ←	9.7 ←	9.8 →	9.4 →	9.1 ←
	9.2 ↙	9.9 ↙	10.0 ↑	9.8 ↑	10.8 *
beste Teiler	37.5 (20.)	229.4 (11.)	238.3 (18.)		
Trefferlage	0.92 mm links, 0.04 mm hoch				
Streuwert	2.25, horizontal: 2.66, vertikal: 1.75				

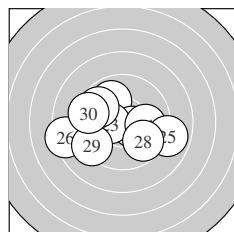

Serie 3:	9.9 ↖	10.5 *	10.4 *	9.9 →	8.9 →
	8.3 ←	9.7 ↖	9.7 ↘	9.3 ↙	9.4 ←
beste Teiler	114.4 (22.)	138.6 (23.)	252.6 (24.)		
Trefferlage	0.79 mm links, 0.37 mm tief				
Streuwert	2.69, horizontal: 3.43, vertikal: 1.63				

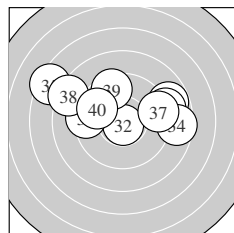

Serie 4:	8.8 →	10.8 *	9.0 →	8.6 →	7.4 ↖
	9.3 ←	9.3 →	8.3 ↖	9.5 ↗	9.7 ↖
beste Teiler	43.4 (32.)	313.0 (40.)	370.0 (39.)		
Trefferlage	0.23 mm links, 1.57 mm hoch				
Streuwert	3.69, horizontal: 4.98, vertikal: 1.55				

Unterschrift des Schützen

Ergebnis: **382** (400.5)
 Serien: 96 93 98 95
 Zähler: 27 9 3 1 0 0 0 0 0 0
 Innenzehner: 21
 weiteste: 806 (3), 592 (11), 572 (16)
 beste Teiler 8.5 (15.) 30.6 (1.) 55.4 (40.)
 Trefferlage 0.52 mm links, 0.20 mm tief
 Streuwert 2.02, horizontal: 2.63, vertikal: 1.13

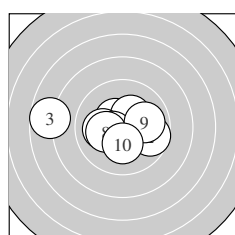
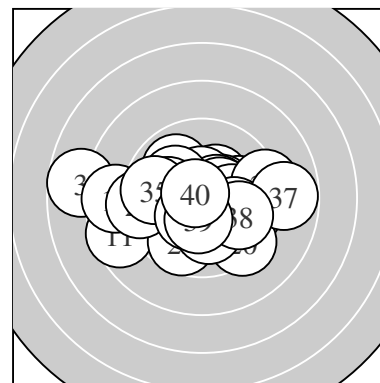

Serie 1:
 10.8 * 9.7 → 7.7 ← 10.5 * 10.3 *
 10.1 ← 10.5 * 10.2 * 10.0 → 10.2 *
 beste Teiler 30.6 (1.) 120.4 (7.) 122.5 (4.)
 Trefferlage 0.78 mm links, 0.03 mm tief
 Streuwert 2.26, horizontal: 3.05, vertikal: 0.97

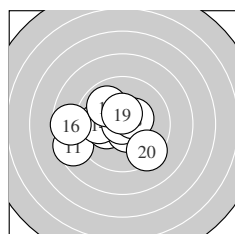

Serie 2:
 8.6 ← 10.2 * 10.6 * 9.9 ← 10.9 *
 8.7 ← 9.9 ↘ 10.4 * 10.5 * 9.4 ↘
 beste Teiler 8.5 (15.) 99.1 (13.) 116.2 (19.)
 Trefferlage 1.30 mm links, 0.27 mm tief
 Streuwert 2.20, horizontal: 2.73, vertikal: 1.48

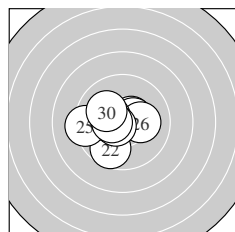

Serie 3:
 10.5 * 9.7 ↙ 10.4 * 10.5 * 9.3 ←
 10.2 * 10.4 * 10.6 * 10.5 * 10.1 ↘
 beste Teiler 85.0 (28.) 111.5 (21.) 117.0 (29.)
 Trefferlage 0.78 mm links, 0.09 mm tief
 Streuwert 1.46, horizontal: 1.75, vertikal: 1.10

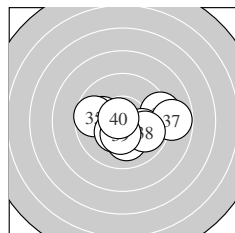

Serie 4:
 9.2 → 10.1 ↓ 10.0 ← 10.0 → 9.7 ←
 10.4 * 8.8 → 9.9 → 10.4 * 10.7 *
 beste Teiler 55.4 (40.) 144.0 (39.) 148.0 (36.)
 Trefferlage 0.76 mm rechts, 0.43 mm tief
 Streuwert 2.07, horizontal: 2.74, vertikal: 1.03

Unterschrift des Schützen

Meyton Elektronik

Ergebnis:	397	(412.4)
Serien:	99 99 100 99	
Zähler:	37 3 0 0 0 0 0 0 0 0	
Innenzehner:	29	
weiteste:	372 (39), 324 (18), 266 (10)	
beste Teiler	21.8 (22.) 32.8 (3.) 64.0 (2.)	
Trefferlage	0.10 mm rechts, 0.18 mm tief	
Streuwert	1.25, horizontal: 1.31, vertikal: 1.19	

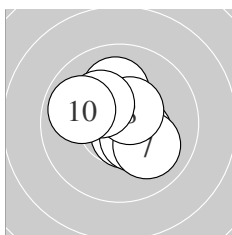
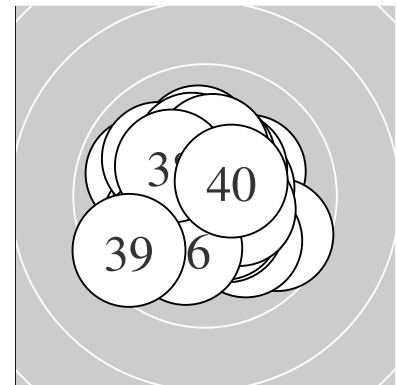

Serie 1:	10.4 *	10.7 *	10.8 *	10.6 *	10.4 *
	10.1 ↑	10.0 ↘	10.5 *	10.2 *	9.9 ↙
beste Teiler	32.8 (3.)	64.0 (2.)	81.0 (4.)		
Trefferlage	0.11 mm rechts, 0.23 mm hoch				
Streuwert	1.19, horizontal: 1.25, vertikal: 1.13				

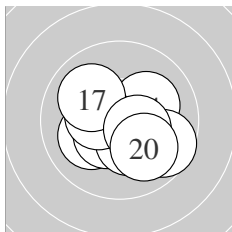

Serie 2:	10.1 ↙	10.3 *	10.4 *	10.1 ↗	10.3 *
	10.4 *	10.0 ↘	9.7 ↘	10.4 *	10.0 ↘
beste Teiler	128.3 (13.)	131.9 (19.)	142.7 (16.)		
Trefferlage	0.36 mm rechts, 0.48 mm tief				
Streuwert	1.44, horizontal: 1.71, vertikal: 1.11				

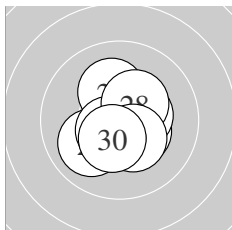

Serie 3:	10.4 *	10.9 *	10.6 *	10.0 ↙	10.2 *
	10.6 *	10.4 *	10.4 *	10.4 *	10.4 *
beste Teiler	21.8 (22.)	79.2 (23.)	96.1 (26.)		
Trefferlage	0.13 mm rechts, 0.25 mm tief				
Streuwert	1.06, horizontal: 1.02, vertikal: 1.09				

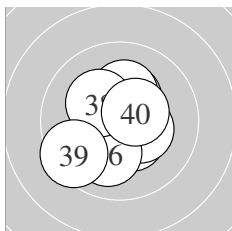

Serie 4:	10.3 *	10.6 *	10.6 *	10.4 *	10.4 *
	10.1 ↓	10.2 *	10.2 *	9.5 ↙	10.5 *
beste Teiler	99.1 (32.)	100.4 (33.)	119.5 (40.)		
Trefferlage	0.17 mm links, 0.25 mm tief				
Streuwert	1.38, horizontal: 1.32, vertikal: 1.45				

Unterschrift des Schützen

Ergebnis: **375** (393.6)
 Serien: 95 94 94 92
 Zähler: 21 13 6 0 0 0 0 0 0 0
 Innenzehner: 16
 weiteste: 626 (22), 563 (20), 560 (40)
 beste Teiler 36.1 (31.) 58.0 (18.) 70.9 (25.)
 Trefferlage 0.74 mm links, 1.16 mm tief
 Streuwert 2.07, horizontal: 2.19, vertikal: 1.94

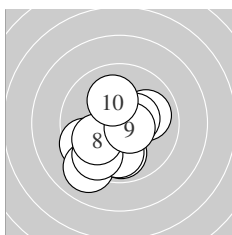
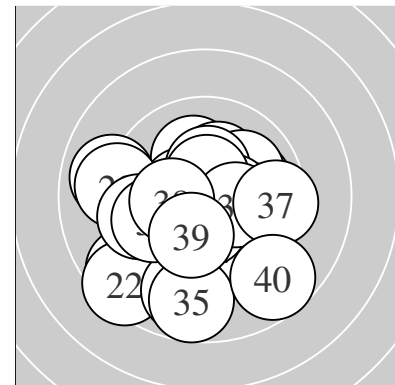

Serie 1:
 10.0 → 9.5 ↙ 9.1 ↙ 9.9 ↓ 9.9 ↓
 9.6 ↘ 10.4 * 10.0 ↙ 10.6 * 10.1 ↑
 beste Teiler 96.6 (9.) 136.9 (7.) 209.3 (10.)
 Trefferlage 0.57 mm links, 1.23 mm tief
 Streuwert 1.83, horizontal: 1.81, vertikal: 1.85

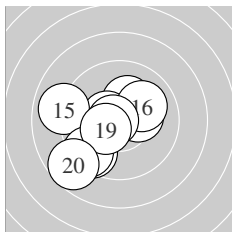

Serie 2:
 10.2 * 10.5 * 9.4 ↙ 10.3 * 8.9 ←
 10.0 ↗ 9.4 ↙ 10.7 * 10.4 * 8.7 ↘
 beste Teiler 58.0 (18.) 115.5 (12.) 144.2 (19.)
 Trefferlage 1.28 mm links, 0.58 mm tief
 Streuwert 2.13, horizontal: 2.31, vertikal: 1.94

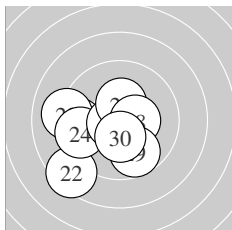

Serie 3:
 9.5 ← 8.4 ↙ 9.1 ← 9.5 ← 10.7 *
 10.4 * 10.3 * 10.4 * 9.7 ↓ 10.4 *
 beste Teiler 70.9 (25.) 137.0 (28.) 146.6 (26.)
 Trefferlage 1.29 mm links, 0.98 mm tief
 Streuwert 2.11, horizontal: 2.44, vertikal: 1.73

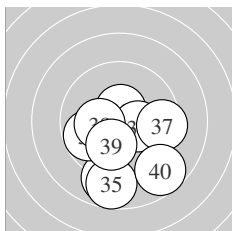

Serie 4:
 10.8 * 10.6 * 10.3 * 8.9 ↓ 8.7 ↓
 9.8 ↙ 9.5 → 10.2 * 10.1 ↓ 8.7 ↘
 beste Teiler 36.1 (31.) 98.4 (32.) 167.7 (33.)
 Trefferlage 0.19 mm rechts, 1.86 mm tief
 Streuwert 2.21, horizontal: 2.16, vertikal: 2.27

Unterschrift des Schützen

Meyton Elektronik

Ergebnis: **394** (409.9)
 Serien: 98 98 99 99
 Zähler: 34 6 0 0 0 0 0 0 0 0
 Innenzehner: 24
 weiteste: 334 (16), 303 (1), 298 (11)
 beste Teiler 22.1 (25.) 30.0 (15.) 46.1 (31.)
 Trefferlage 0.66 mm links, 0.21 mm tief
 Streuwert 1.28, horizontal: 1.27, vertikal: 1.29

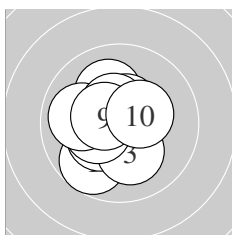
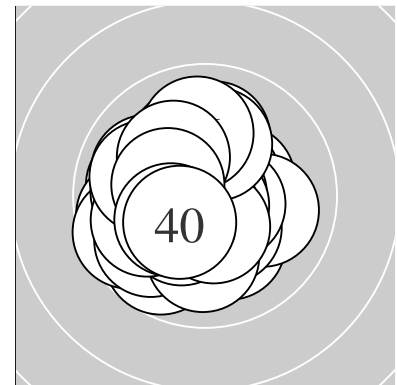

Serie 1:
 9.7 ↘ 10.3 * 10.2 * 10.3 * 10.1 ↗
 10.5 * 9.9 ← 10.5 * 10.5 * 10.4 *
 beste Teiler 110.0 (9.) 110.6 (6.) 113.2 (8.)
 Trefferlage 0.66 mm links, 0.01 mm tief
 Streuwert 1.30, horizontal: 1.19, vertikal: 1.39

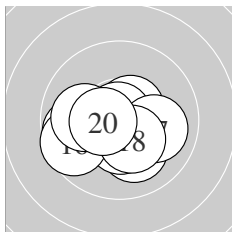

Serie 2:
 9.8 ← 10.1 ↘ 10.4 * 10.5 * 10.8 *
 9.6 ← 10.0 → 10.4 * 10.0 ← 10.5 *
 beste Teiler 30.0 (15.) 101.8 (14.) 110.3 (20.)
 Trefferlage 0.45 mm links, 0.61 mm tief
 Streuwert 1.41, horizontal: 1.80, vertikal: 0.86

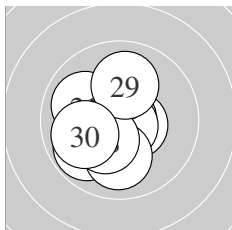

Serie 3:
 10.0 ↖ 10.6 * 10.2 * 9.8 ↙ 10.9 *
 10.8 * 10.0 ↓ 10.3 * 10.0 ↑ 10.0 ←
 beste Teiler 22.1 (25.) 48.4 (26.) 100.2 (22.)
 Trefferlage 0.69 mm links, 0.54 mm tief
 Streuwert 1.32, horizontal: 1.22, vertikal: 1.41

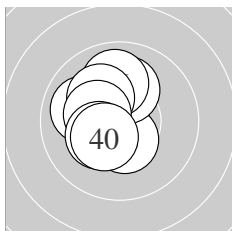

Serie 4:
 10.8 * 10.4 * 10.4 * 10.0 ↖ 10.1 ↑
 9.9 ↑ 10.2 * 10.3 * 10.3 * 10.4 *
 beste Teiler 46.1 (31.) 127.6 (33.) 142.6 (32.)
 Trefferlage 0.84 mm links, 0.31 mm hoch
 Streuwert 1.15, horizontal: 0.89, vertikal: 1.36

Unterschrift des Schützen

Ergebnis: **365** (382.5)
 Serien: 90 93 89 93
 Zähler: 13 19 8 0 0 0 0 0 0
 Innenzehner: 10
 weiteste: 694 (35), 692 (7), 683 (21)
 beste Teiler 42.7 (38.) 72.0 (34.) 79.5 (5.)
 Trefferlage 2.15 mm rechts, 0.35 mm hoch
 Streuwert 2.31, horizontal: 2.56, vertikal: 2.03

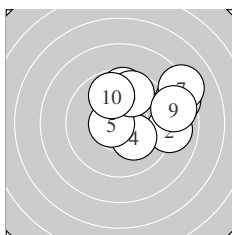
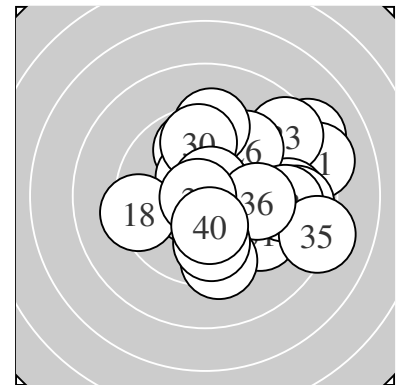

Serie 1:
 10.0 ↑ 9.0 → 8.5 ↗ 10.2 * 10.6 *
 9.7 ↑ 8.2 ↗ 9.7 ↑ 8.8 → 9.8 ↑
 beste Teiler 79.5 (5.) 193.0 (4.) 233.2 (1.)
 Trefferlage 2.25 mm rechts, 1.60 mm hoch
 Streuwert 2.35, horizontal: 2.86, vertikal: 1.70

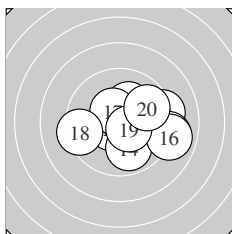

Serie 2:
 10.2 * 9.3 → 10.6 * 9.9 ↓ 9.0 →
 8.9 → 10.4 * 9.3 ← 10.5 * 9.7 →
 beste Teiler 100.4 (13.) 111.0 (19.) 126.0 (17.)
 Trefferlage 1.36 mm rechts, 0.22 mm tief
 Streuwert 2.21, horizontal: 2.80, vertikal: 1.41

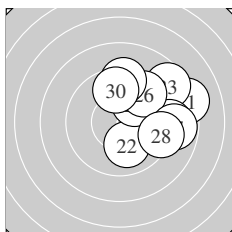

Serie 3:
 8.2 → 10.0 ↓ 8.6 ↗ 9.0 → 10.0 ↗
 9.5 ↗ 8.8 → 9.3 → 9.3 ↑ 9.7 ↑
 beste Teiler 230.2 (22.) 233.3 (25.) 315.2 (30.)
 Trefferlage 2.99 mm rechts, 1.34 mm hoch
 Streuwert 2.28, horizontal: 2.39, vertikal: 2.17

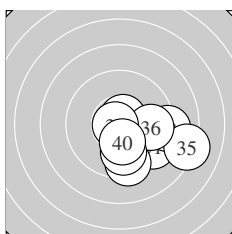

Serie 4:
 9.4 ↘ 10.5 * 9.1 → 10.7 * 8.2 →
 9.7 → 9.4 ↓ 10.8 * 9.8 ↓ 10.2 *
 beste Teiler 42.7 (38.) 72.0 (34.) 105.2 (32.)
 Trefferlage 1.99 mm rechts, 1.29 mm tief
 Streuwert 1.91, horizontal: 2.29, vertikal: 1.44

Unterschrift des Schützen

Meyton Elektronik

Ergebnis: **384** (403.0)
 Serien: 95 99 97 93
 Zähler: 25 14 1 0 0 0 0 0 0 0
 Innenzehner: 22
 weiteste: 642 (39), 490 (35), 452 (31)
 beste Teiler 42.5 (23.) 51.0 (19.) 57.0 (33.)
 Trefferlage 0.64 mm links, 0.04 mm tief
 Streuwert 1.77, horizontal: 2.11, vertikal: 1.35

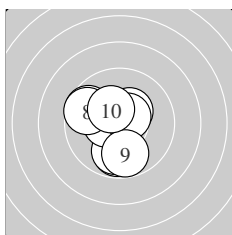
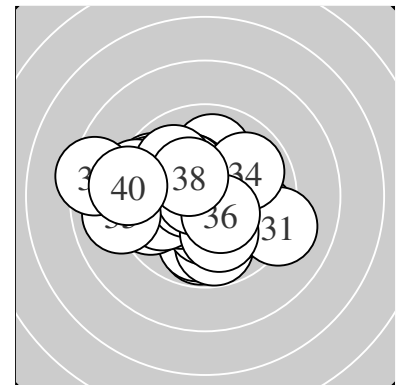

Serie 1:
 9.8 ↓ 9.9 ↓ 9.6 ↖ 10.4 * 10.4 *
 10.5 * 10.6 * 9.6 ↖ 9.8 ↓ 10.3 *
 beste Teiler 97.1 (7.) 124.1 (6.) 142.8 (4.)
 Trefferlage 0.79 mm links, 0.22 mm tief
 Streuwert 1.63, horizontal: 1.41, vertikal: 1.82

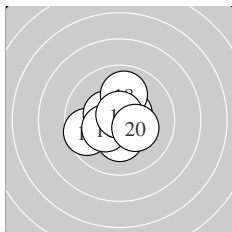

Serie 2:
 10.3 * 9.6 ← 10.6 * 10.6 * 10.4 *
 10.3 * 10.5 * 10.0 ↑ 10.7 * 10.3 *
 beste Teiler 51.0 (19.) 80.4 (13.) 89.3 (14.)
 Trefferlage 0.26 mm links, 0.03 mm hoch
 Streuwert 1.27, horizontal: 1.35, vertikal: 1.19

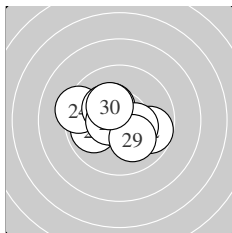

Serie 3:
 9.9 ← 9.7 → 10.8 * 9.3 ← 10.3 *
 10.4 * 10.3 * 10.6 * 10.1 ↓ 10.3 *
 beste Teiler 42.5 (23.) 99.8 (28.) 149.0 (26.)
 Trefferlage 0.48 mm links, 0.00 mm
 Streuwert 1.60, horizontal: 1.98, vertikal: 1.09

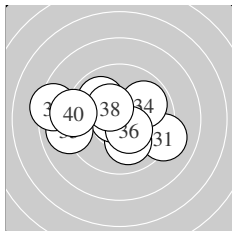

Serie 4:
 9.1 → 10.1 ↓ 10.7 * 9.9 ↗ 9.0 ←
 10.4 * 9.9 ↘ 10.4 * 8.4 ← 9.2 ←
 beste Teiler 57.0 (33.) 135.3 (36.) 143.4 (38.)
 Trefferlage 1.06 mm links, 0.01 mm hoch
 Streuwert 2.55, horizontal: 3.33, vertikal: 1.40

Unterschrift des Schützen

Ergebnis:	394	(413.6)
Serien:	100	98 98 98
Zähler:	34	6 0 0 0 0 0 0 0 0
Innenzehner:	28	
weiteste:	402	(28), 353 (40), 308 (18)
beste Teiler	31.5	(21.) 58.5 (1.) 65.1 (4.)
Trefferlage	0.21	mm rechts, 0.26 mm hoch
Streuwert	1.22,	horizontal: 1.25, vertikal: 1.19

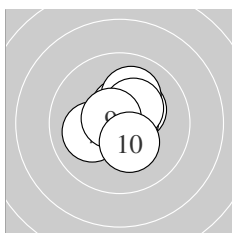
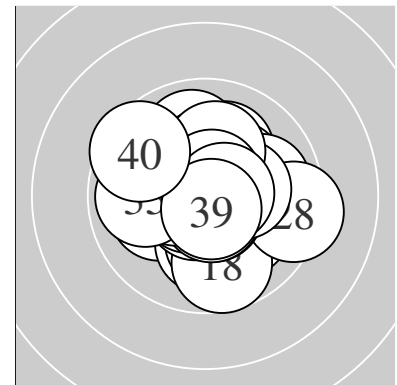

Serie 1:	10.7 *	10.3 *	10.5 *	10.7 *	10.6 *
	10.1 ↗	10.1 ←	10.3 *	10.7 *	10.3 *
beste Teiler	58.5	(1.) 65.1 (4.)	71.6 (9.)		
Trefferlage	0.19	mm rechts, 0.46 mm hoch			
Streuwert	0.99,	horizontal: 1.00, vertikal: 0.98			

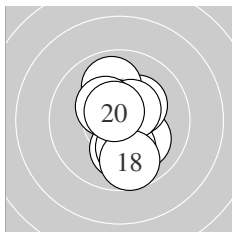

Serie 2:	10.1 ↘	10.6 *	10.1 ↓	10.1 ↓	10.3 *
	9.9 ↑	10.5 *	9.7 ↓	10.4 *	10.6 *
beste Teiler	76.3	(20.) 100.6 (12.)	115.3 (17.)		
Trefferlage	0.35	mm rechts, 0.16 mm tief			
Streuwert	1.41,	horizontal: 0.85, vertikal: 1.81			

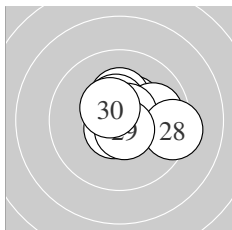

Serie 3:	10.8 *	10.4 *	10.3 *	10.5 *	10.7 *
	9.9 →	10.7 *	9.3 →	10.6 *	10.5 *
beste Teiler	31.5	(21.) 73.5 (27.)	75.7 (25.)		
Trefferlage	0.69	mm rechts, 0.41 mm hoch			
Streuwert	1.19,	horizontal: 1.46, vertikal: 0.85			

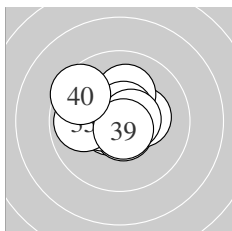

Serie 4:	10.6 *	10.6 *	10.4 *	10.3 *	9.9 ←
	10.1 ↑	10.6 *	10.6 *	10.7 *	9.5 ↘
beste Teiler	65.3	(39.) 76.5 (31.)	77.2 (32.)		
Trefferlage	0.38	mm links, 0.35 mm hoch			
Streuwert	1.26,	horizontal: 1.49, vertikal: 0.96			

Unterschrift des Schützen

Meyton Elektronik

Ergebnis: **396** (415.8)
 Serien: 98 99 100 99
 Zähler: 36 4 0 0 0 0 0 0 0 0
 Innenzehner: 30
 weiteste: 297 (10), 287 (17), 265 (31)
 beste Teiler 7.2 (27.) 12.2 (33.) 35.5 (32.)
 Trefferlage 0.18 mm links, 0.16 mm hoch
 Streuwert 1.12, horizontal: 1.09, vertikal: 1.14

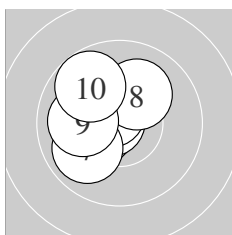
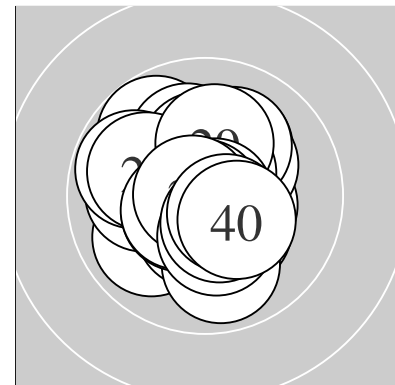

Serie 1:
 10.7 * 10.5 * 10.4 * 10.4 * 10.7 *
 10.6 * 9.9 ↙ 10.1 ↗ 10.0 ← 9.8 ↘
 beste Teiler 64.1 (5.) 68.8 (1.) 92.9 (6.)
 Trefferlage 1.04 mm links, 0.43 mm hoch
 Streuwert 1.04, horizontal: 0.97, vertikal: 1.10

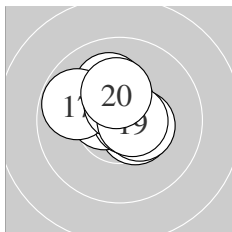

Serie 2:
 10.3 * 10.5 * 10.1 ↑ 10.5 * 10.4 *
 10.7 * 9.8 ↖ 10.6 * 10.6 * 10.3 *
 beste Teiler 54.3 (16.) 82.2 (19.) 97.0 (18.)
 Trefferlage 0.16 mm links, 0.65 mm hoch
 Streuwert 1.05, horizontal: 1.18, vertikal: 0.90

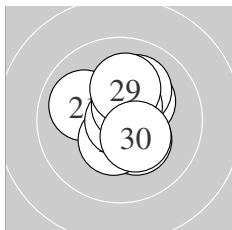

Serie 3:
 10.0 ↖ 10.7 * 10.3 * 10.4 * 10.3 *
 10.1 ↗ 10.9 * 10.6 * 10.1 ↑ 10.4 *
 beste Teiler 7.2 (27.) 70.1 (22.) 99.2 (28.)
 Trefferlage 0.32 mm rechts, 0.36 mm hoch
 Streuwert 1.14, horizontal: 1.04, vertikal: 1.23

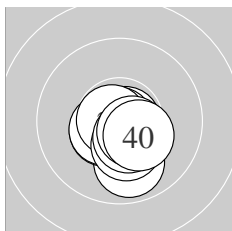

Serie 4:
 9.9 ↓ 10.8 * 10.9 * 10.5 * 10.5 *
 10.8 * 10.3 * 10.5 * 10.5 * 10.4 *
 beste Teiler 12.2 (33.) 35.5 (32.) 49.2 (36.)
 Trefferlage 0.14 mm rechts, 0.80 mm tief
 Streuwert 0.77, horizontal: 0.74, vertikal: 0.80

Unterschrift des Schützen

Ergebnis: **392** (408.9)
 Serien: 97 100 97 98
 Zähler: 32 8 0 0 0 0 0 0 0 0
 Innenzehner: 25
 weiteste: 375 (28), 324 (5), 315 (10)
 beste Teiler 44.0 (9.) 70.6 (2.) 74.3 (15.)
 Trefferlage 0.08 mm rechts, 0.20 mm tief
 Streuwert 1.42, horizontal: 1.46, vertikal: 1.37

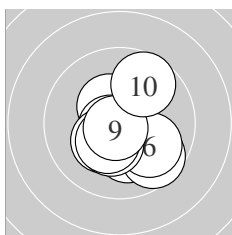
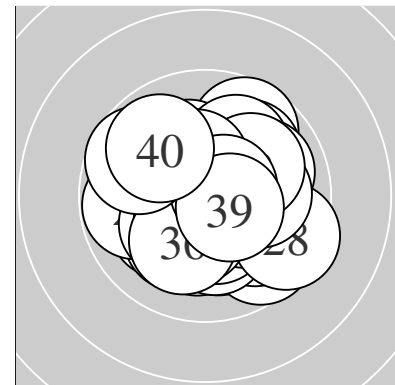

Serie 1:
 10.4 * 10.7 * 10.2 * 10.3 * 9.7 ↘
 9.9 ↘ 10.3 * 10.4 * 10.8 * 9.7 ↗
 beste Teiler 44.0 (9.) 70.6 (2.) 137.3 (1.)
 Trefferlage 0.24 mm rechts, 0.63 mm tief
 Streuwert 1.42, horizontal: 1.31, vertikal: 1.52

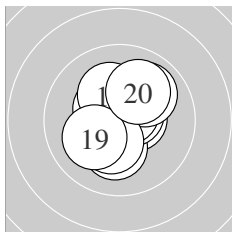

Serie 2:
 10.5 * 10.2 * 10.6 * 10.4 * 10.7 *
 10.0 ↗ 10.2 * 10.3 * 10.1 ↙ 10.0 ↗
 beste Teiler 74.3 (15.) 94.3 (13.) 105.3 (11.)
 Trefferlage 0.11 mm rechts, 0.27 mm hoch
 Streuwert 1.28, horizontal: 1.14, vertikal: 1.40

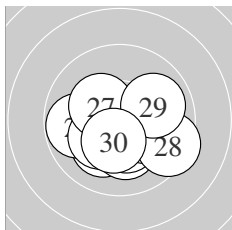

Serie 3:
 10.1 ↙ 9.8 ← 10.2 * 10.2 * 10.4 *
 10.2 * 10.3 * 9.5 ↘ 9.9 → 10.4 *
 beste Teiler 149.0 (30.) 149.2 (25.) 162.6 (27.)
 Trefferlage 0.11 mm rechts, 0.84 mm tief
 Streuwert 1.55, horizontal: 1.92, vertikal: 1.07

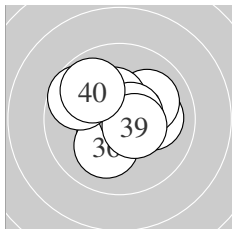

Serie 4:
 10.1 → 10.1 ↗ 10.6 * 10.4 * 10.5 *
 10.1 ↙ 10.6 * 9.7 ↘ 10.5 * 9.9 ↘
 beste Teiler 82.6 (37.) 88.0 (33.) 113.6 (39.)
 Trefferlage 0.13 mm links, 0.37 mm hoch
 Streuwert 1.42, horizontal: 1.59, vertikal: 1.21

Unterschrift des Schützen

Meyton Elektronik

Ergebnis: **390** (409.2)
 Serien: 96 99 95 100
 Zähler: 30 10 0 0 0 0 0 0 0 0
 Innenzehner: 25
 weiteste: 463 (22), 410 (3), 395 (9)
 beste Teiler 17.2 (33.) 17.4 (14.) 24.1 (8.)
 Trefferlage 0.28 mm rechts, 0.36 mm hoch
 Streuwert 1.49, horizontal: 1.68, vertikal: 1.26

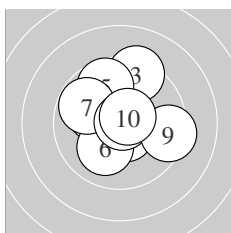
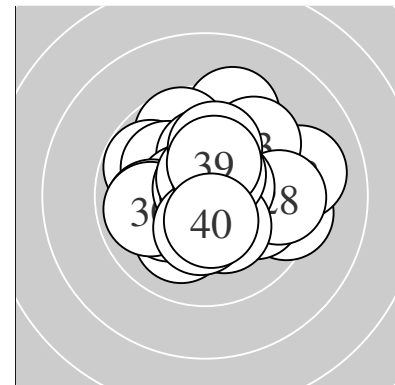

Serie 1:
 10.1 ↖ 10.5 * 9.3 ↑ 10.6 * 9.7 ↗
 10.1 ↙ 9.8 ↖ 10.9 * 9.4 → 10.6 *
 beste Teiler 24.1 (8.) 81.8 (10.) 95.0 (4.)
 Trefferlage 0.14 mm links, 0.65 mm hoch
 Streuwert 1.81, horizontal: 1.87, vertikal: 1.74

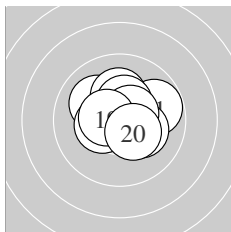

Serie 2:
 9.8 → 10.2 * 10.1 ↖ 10.9 * 10.2 *
 10.4 * 10.4 * 10.6 * 10.5 * 10.4 *
 beste Teiler 17.4 (14.) 100.4 (18.) 103.9 (19.)
 Trefferlage 0.24 mm rechts, 0.43 mm hoch
 Streuwert 1.20, horizontal: 1.40, vertikal: 0.95

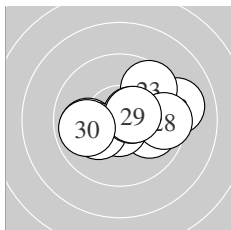

Serie 3:
 10.0 → 9.1 → 9.6 ↗ 9.9 ← 10.7 *
 10.2 * 10.5 * 9.5 → 10.5 * 9.9 ←
 beste Teiler 64.1 (25.) 101.6 (27.) 114.3 (29.)
 Trefferlage 0.78 mm rechts, 0.09 mm hoch
 Streuwert 1.91, horizontal: 2.48, vertikal: 1.06

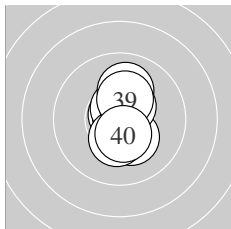

Serie 4:
 10.6 * 10.8 * 10.9 * 10.3 * 10.6 *
 10.0 ↑ 10.3 * 10.5 * 10.3 * 10.5 *
 beste Teiler 17.2 (33.) 43.8 (32.) 82.2 (31.)
 Trefferlage 0.25 mm rechts, 0.28 mm hoch
 Streuwert 0.95, horizontal: 0.38, vertikal: 1.29

Unterschrift des Schützen

Ergebnis: **388** (406.1)
 Serien: 100 94 96 98
 Zähler: 28 12 0 0 0 0 0 0 0 0
 Innenzehner: 21
 weiteste: 467 (16), 402 (28), 382 (11)
 beste Teiler 39.2 (20.) 40.6 (2.) 49.4 (5.)
 Trefferlage 0.04 mm links, 0.27 mm hoch
 Streuwert 1.60, horizontal: 1.84, vertikal: 1.33

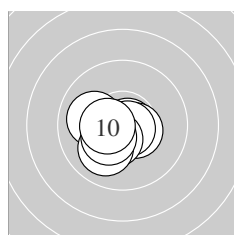
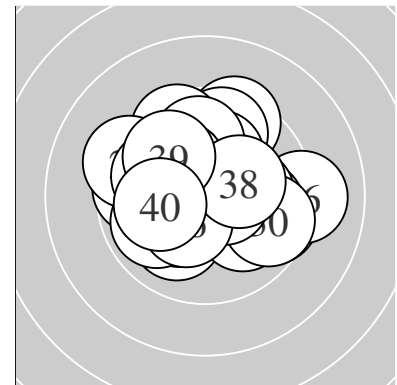

Serie 1:
 10.6 * 10.8 * 10.5 * 10.5 * 10.8 *
 10.4 * 10.0 ← 10.0 ↙ 10.4 * 10.5 *
 beste Teiler 40.6 (2.) 49.4 (5.) 79.4 (1.)
 Trefferlage 0.64 mm links, 0.51 mm tief
 Streuwert 0.85, horizontal: 1.00, vertikal: 0.67

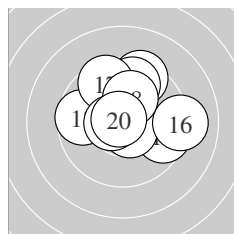

Serie 2:
 9.4 ↗ 9.6 → 9.7 ← 9.7 ↑ 10.6 *
 9.1 → 9.6 ↘ 10.1 ↑ 10.6 * 10.8 *
 beste Teiler 39.2 (20.) 87.0 (15.) 89.2 (19.)
 Trefferlage 0.55 mm rechts, 1.04 mm hoch
 Streuwert 2.00, horizontal: 2.26, vertikal: 1.71

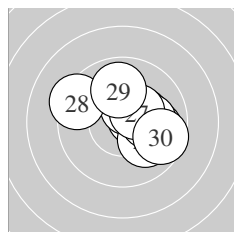

Serie 3:
 10.5 * 9.9 → 10.3 * 10.5 * 10.0 ↘
 10.1 → 10.4 * 9.3 ↖ 9.9 ↑ 9.6 →
 beste Teiler 106.5 (21.) 125.9 (24.) 142.0 (27.)
 Trefferlage 0.97 mm rechts, 0.40 mm hoch
 Streuwert 1.61, horizontal: 1.92, vertikal: 1.24

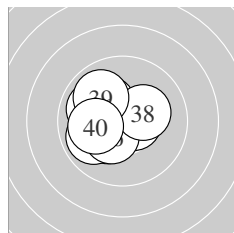

Serie 4:
 10.3 * 10.3 * 10.0 ↖ 9.9 ↙ 10.6 *
 10.4 * 10.2 * 10.2 * 9.9 ↘ 10.1 ←
 beste Teiler 90.9 (35.) 150.8 (36.) 154.5 (32.)
 Trefferlage 1.06 mm links, 0.16 mm hoch
 Streuwert 1.26, horizontal: 1.35, vertikal: 1.16

Unterschrift des Schützen

Meyton Elektronik

Ergebnis: **388** (405.8)
 Serien: 97 96 98 97
 Zähler: 28 12 0 0 0 0 0 0 0 0
 Innenzehner: 22
 weiteste: 455 (13), 429 (35), 379 (14)
 beste Teiler 39.6 (1.) 43.0 (3.) 62.4 (18.)
 Trefferlage 0.42 mm links, 0.28 mm tief
 Streuwert 1.59, horizontal: 1.53, vertikal: 1.64

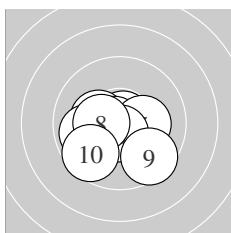
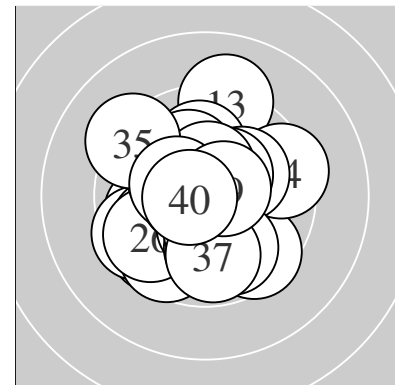

Serie 1:
 10.8 * 10.3 * 10.8 * 10.1 ↙ 10.2 *
 10.6 * 9.9 ↙ 10.4 * 9.5 ↘ 9.6 ↙
 beste Teiler 39.6 (1.) 43.0 (3.) 81.0 (6.)
 Trefferlage 0.58 mm links, 0.67 mm tief
 Streuwert 1.41, horizontal: 1.70, vertikal: 1.05

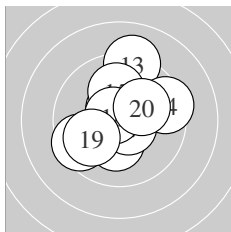

Serie 2:
 10.2 * 10.5 * 9.1 ↑ 9.4 → 10.0 ↑
 9.5 ↙ 10.6 * 10.7 * 9.9 ↙ 10.1 →
 beste Teiler 62.4 (18.) 85.2 (17.) 102.0 (12.)
 Trefferlage 0.02 mm rechts, 0.48 mm hoch
 Streuwert 1.93, horizontal: 1.91, vertikal: 1.96

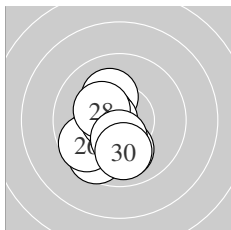

Serie 3:
 10.2 * 10.0 ↓ 10.0 ↙ 10.5 * 9.6 ↙
 9.7 ↙ 10.6 * 10.3 * 10.4 * 10.0 ↓
 beste Teiler 82.0 (27.) 114.4 (24.) 145.0 (29.)
 Trefferlage 0.97 mm links, 0.91 mm tief
 Streuwert 1.31, horizontal: 1.00, vertikal: 1.56

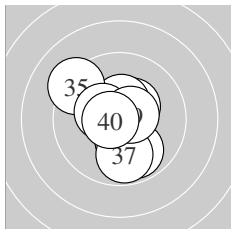

Serie 4:
 10.3 * 10.6 * 10.4 * 10.4 * 9.2 ↘
 9.9 ↓ 9.8 ↓ 10.4 * 10.6 * 10.7 *
 beste Teiler 73.3 (40.) 93.4 (39.) 94.3 (32.)
 Trefferlage 0.14 mm links, 0.02 mm tief
 Streuwert 1.57, horizontal: 1.38, vertikal: 1.74

Unterschrift des Schützen