

AR 40

StandNr: 132

Holzkecht,, Wolfgang #538**Senioren_1m**

Wertung

StartNr: 89

11.01.2025 15:21

SG_Hötting-Ibk

Ergebnis: **406.9** (390)
 Serien: 101.3 101.9 102.8 100.9
 Zähler: 30 10 0 0 0 0 0 0 0 0
 Innenzehner: 22
 Weitester: 426 (17.), 422 (9.), 363 (40.)
 beste Teiler: 50.4 (4.), 70.3 (13.), 72.0 (11.)
 Trefferlage: 0.19 mm links, 0.74 mm hoch
 Streuwert: 1.46, horizontal: 1.35, vertikal: 1.56

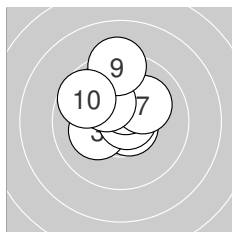
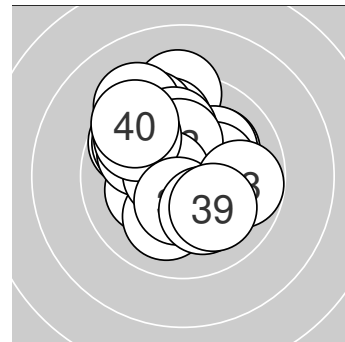
**Serie 1: 101.3 (97)**

10.1 ↑	10.6* ↘	10.2* ←	10.8* →	9.9 ↘
10.4* ↑	10.1 ↗	10.2* ↘	9.3 ↑	9.7 ↘

beste Teiler: 50.4 (4.), 77.3 (2.), 128.3 (6.)
 Trefferlage: 0.46 mm links, 1.27 mm hoch
 Streuwert: 1.37, horizontal: 1.32, vertikal: 1.42

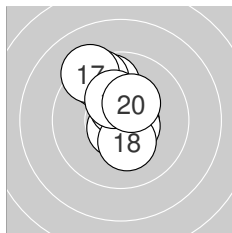
**Serie 2: 101.9 (97)**

10.7* →	10.6* ↘	10.7* ↘	9.8 ↑	9.5 ↘
10.5* ↑	9.2 ↘	10.3* ↓	10.3* ↑	10.3* ↗

beste Teiler: 70.3 (13.), 72.0 (11.), 90.4 (12.)
 Trefferlage: 0.28 mm links, 1.07 mm hoch
 Streuwert: 1.45, horizontal: 1.07, vertikal: 1.75

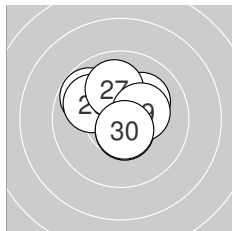
**Serie 3: 102.8 (99)**

10.6* ↗	10.2* ↗	10.1 ↗	10.6* ↘	9.8 ↘
10.0 ↘	10.0 ↑	10.6* ↓	10.3* →	10.6* ↓

beste Teiler: 78.5 (21.), 87.3 (30.), 95.1 (28.)
 Trefferlage: 0.01 mm rechts, 0.80 mm hoch
 Streuwert: 1.24, horizontal: 1.43, vertikal: 1.02

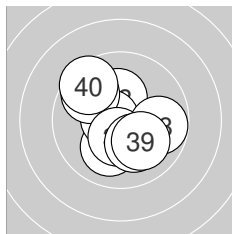
**Serie 4: 100.9 (97)**

10.3* ↓	10.1 ↓	10.3* ↑	10.6* ←	9.7 ↘
10.4* ↓	10.1 ↓	9.8 →	10.1 ↓	9.5 ↘

beste Teiler: 84.5 (34.), 130.6 (36.), 155.7 (31.)
 Trefferlage: 0.06 mm links, 0.19 mm tief
 Streuwert: 1.71, horizontal: 1.68, vertikal: 1.74



AR 40

StandNr: 133

Brüstle,, Robert #536**Senioren_1m**

Wertung

StartNr: 90

11.01.2025 15:09

SG_Wattens-Rettenberg

Ergebnis: **394.4** (378)
 Serien: 97.5 98.1 99.4 99.4
 Zähler: 20 18 2 0 0 0 0 0 0 0
 Innenzehner: 13
 Weitestе: 535 (35.), 532 (22.), 468 (36.)
 beste Teiler: 6.4 (34.), 59.1 (27.), 111.0 (39.)
 Trefferlage: 0.89 mm links, 0.11 mm tief
 Streuwert: 2.06, horizontal: 2.18, vertikal: 1.93

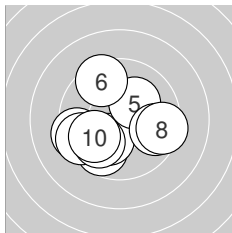
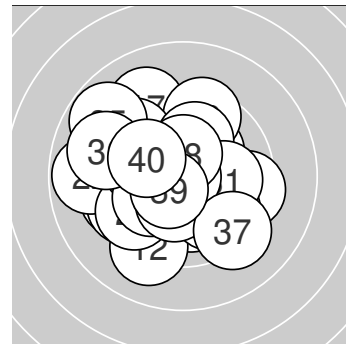
**Serie 1: 97.5 (92)**

9.7 ↙	9.4 ←	10.2* ↓	9.5 ↙	10.2* ↗
9.5 ↘	9.7 →	9.5 →	9.9 ↘	9.9 ↘

beste Teiler: 191.7 (5.), 198.7 (3.), 264.0 (10.)
 Trefferlage: 0.69 mm links, 0.77 mm tief
 Streuwert: 2.20, horizontal: 2.54, vertikal: 1.80

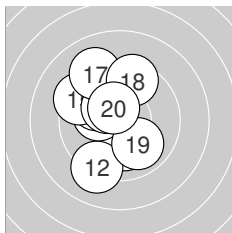
**Serie 2: 98.1 (95)**

10.1 ↓	9.1 ↙	10.2* ←	10.0 ↘	9.4 ↘
10.3* ↘	9.1 ↘	9.5 ↑	9.9 ↘	10.5* ↘

beste Teiler: 118.0 (20.), 154.8 (16.), 187.7 (13.)
 Trefferlage: 0.98 mm links, 0.50 mm hoch
 Streuwert: 2.13, horizontal: 1.61, vertikal: 2.55

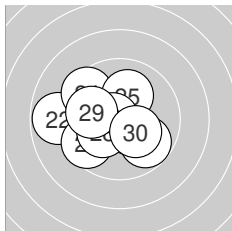
**Serie 3: 99.4 (95)**

9.8 ↘	8.8 ←	10.5* ↘	9.5 ↘	10.1 ↑
9.6 ↙	10.7* ←	10.2* ↙	10.0 ←	10.2* ↘

beste Teiler: 59.1 (27.), 119.5 (23.), 176.0 (30.)
 Trefferlage: 1.02 mm links, 0.19 mm tief
 Streuwert: 1.97, horizontal: 2.36, vertikal: 1.50

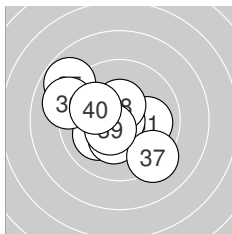
**Serie 4: 99.4 (96)**

10.0 →	10.1 ↙	10.3* ↓	10.9* ↙	8.8 ↘
9.1 ←	9.3 ↘	10.4* ↑	10.5* ↙	10.0 ↘

beste Teiler: 6.4 (34.), 111.0 (39.), 129.0 (38.)
 Trefferlage: 0.88 mm links, 0.00 mm
 Streuwert: 2.14, horizontal: 2.43, vertikal: 1.81



Ergebnis: **388.5** (370)
 Serien: 97.7 96.6 97.5 96.7
 Zähler: 14 22 4 0 0 0 0 0 0 0
 Innenzehner: 10
 Weitester: 680 (21.), 607 (13.), 577 (34.)
 beste Teiler: 89.8 (8.), 91.7 (37.), 95.4 (25.)
 Trefferlage: 0.01 mm links, 0.22 mm tief
 Streuwert: 2.42, horizontal: 2.48, vertikal: 2.36

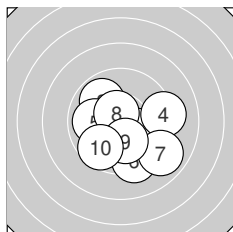
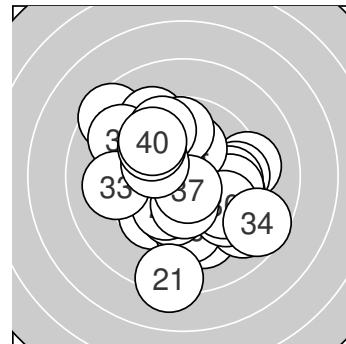

Serie 1: 97.7 (92)

9.8 ↘	9.9 ↖	10.3* ↘	9.2 →	9.9 ←
9.3 ↓	8.9 ↘	10.6* ↖	10.2* ↓	9.6 ↙

beste Teiler: 89.8 (8.), 162.8 (3.), 200.8 (9.)
 Trefferlage: 0.71 mm rechts, 0.99 mm tief
 Streuwert: 2.18, horizontal: 2.43, vertikal: 1.89

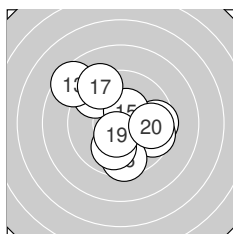

Serie 2: 96.6 (92)

9.6 →	9.5 ↖	8.5 ↘	9.6 →	10.4* ↗
9.5 ↓	9.3 ↖	10.0 ↓	10.5* ↙	9.7 →

beste Teiler: 118.3 (19.), 132.0 (15.), 245.6 (18.)
 Trefferlage: 0.03 mm rechts, 0.31 mm hoch
 Streuwert: 2.60, horizontal: 2.68, vertikal: 2.51

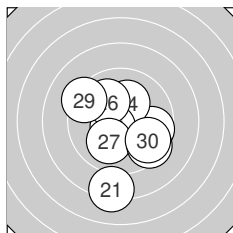

Serie 3: 97.5 (94)

8.2 ↓	10.4* ↘	9.7 →	10.2* ↗	10.6* ↙
10.0 ↖	10.0 ↙	9.5 ↘	9.3 ↖	9.6 ↘

beste Teiler: 95.4 (25.), 144.4 (22.), 193.5 (24.)
 Trefferlage: 0.26 mm rechts, 0.94 mm tief
 Streuwert: 2.43, horizontal: 2.20, vertikal: 2.65

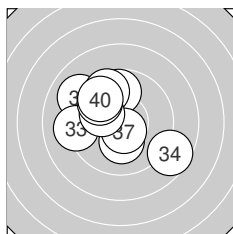

Serie 4: 96.7 (92)

9.8 ↑	9.1 ↖	9.2 ←	8.6 ↘	9.6 ↖
10.2* ↓	10.6* ↓	10.1 ↖	9.8 ↖	9.7 ↖

beste Teiler: 91.7 (37.), 188.2 (36.), 201.9 (38.)
 Trefferlage: 1.06 mm links, 0.71 mm hoch
 Streuwert: 2.42, horizontal: 2.63, vertikal: 2.18



AR 40

StandNr: 122

Mair,, Franz #70606011**Senioren_2m**

Wertung

StartNr: 155

11.01.2025 15:28

SG_Innervillgraten

Ergebnis: **400.0** (383)
 Serien: 97.6 98.2 100.1 104.1
 Zähler: 25 13 2 0 0 0 0 0 0 0
 Innenzehner: 17
 Weitestе: 543 (14.), 505 (24.), 496 (5.)
 beste Teiler: 29.2 (23.), 52.9 (35.), 71.8 (31.)
 Trefferlage: 0.42 mm rechts, 0.05 mm tief
 Streuwert: 1.91, horizontal: 1.98, vertikal: 1.83

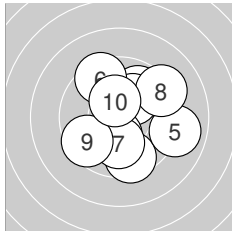
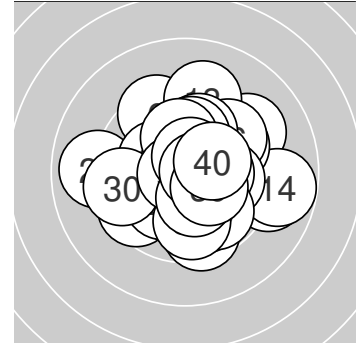
**Serie 1: 97.6 (94)**

9.5 ↓ 9.9 ↗ 10.2* ↗ 10.3* ↓ 9.0 →
 9.4 ↘ 10.1 ↓ 9.2 ↗ 9.6 ↖ 10.4* ↑

beste Teiler: 147.8 (10.), 157.5 (4.), 192.4 (3.)
 Trefferlage: 0.68 mm rechts, 0.04 mm hoch
 Streuwert: 2.34, horizontal: 2.29, vertikal: 2.39

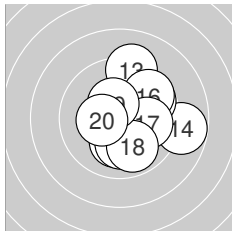
**Serie 2: 98.2 (94)**

10.1 ↓ 10.1 ↓ 9.2 ↑ 8.8 → 9.7 ↗
 9.7 ↗ 10.0 → 9.9 ↓ 10.4* ↘ 10.3* ←

beste Teiler: 137.8 (19.), 154.9 (20.), 206.7 (11.)
 Trefferlage: 1.26 mm rechts, 0.08 mm hoch
 Streuwert: 2.08, horizontal: 2.02, vertikal: 2.14

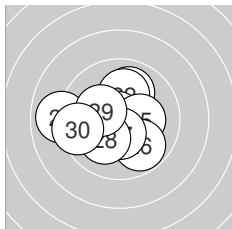
**Serie 3: 100.1 (96)**

10.0 ↑ 10.1 ↑ 10.8* ↘ 8.9 ← 10.2* →
 9.8 ↘ 10.5* ↓ 10.1 ↖ 10.2* ↖ 9.5 ←

beste Teiler: 29.2 (23.), 125.1 (27.), 176.1 (25.)
 Trefferlage: 0.71 mm links, 0.05 mm tief
 Streuwert: 1.91, horizontal: 2.24, vertikal: 1.51

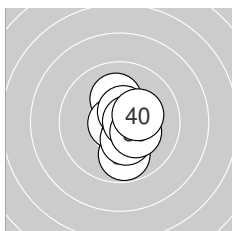
**Serie 4: 104.1 (99)**

10.7* ↓ 10.7* ↓ 9.8 ↓ 10.1 ↑ 10.7* ←
 10.3* ↓ 10.6* ↑ 10.6* → 10.3* ↘ 10.3* →

beste Teiler: 52.9 (35.), 71.8 (31.), 73.9 (32.)
 Trefferlage: 0.47 mm rechts, 0.29 mm tief
 Streuwert: 1.06, horizontal: 0.66, vertikal: 1.34



Ergebnis: **393.2** (375)
 Serien: 98.0 102.0 96.8 96.4
 Zähler: 17 21 2 0 0 0 0 0 0 0
 Innenzehner: 15
 Weitester: 602 (7.), 581 (24.), 486 (39.)
 beste Teiler: 21.2 (15.), 47.4 (13.), 67.4 (2.)
 Trefferlage: 0.05 mm links, 0.11 mm tief
 Streuwert: 2.29, horizontal: 2.78, vertikal: 1.65

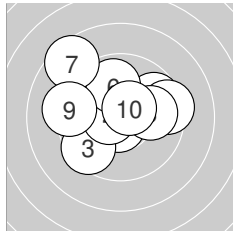
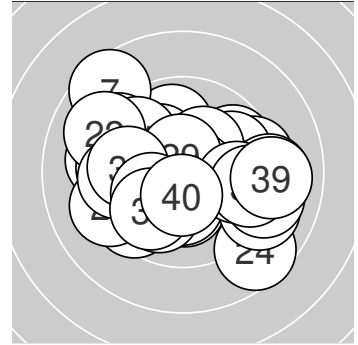

Serie 1: 98.0 (93)

9.7 ↗	10.7* ↓	9.5 ↙	10.6* ←	9.4 →
9.9 ↑	8.5 ↘	10.0 →	9.2 ←	10.5* ↗

beste Teiler: 67.4 (2.), 95.0 (4.), 103.2 (10.)
 Trefferlage: 0.28 mm links, 0.80 mm hoch
 Streuwert: 2.37, horizontal: 2.80, vertikal: 1.85

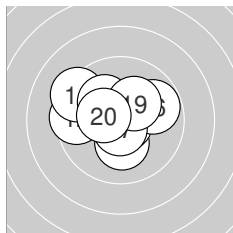

Serie 2: 102.0 (97)

10.2* ↓	9.5 ←	10.8* ↘	9.3 ↘	10.9* ←
9.8 ↗	10.7* ↓	10.2* ↘	10.2* ↗	10.4* ←

beste Teiler: 21.2 (15.), 47.4 (13.), 69.1 (17.)
 Trefferlage: 0.58 mm links, 0.38 mm hoch
 Streuwert: 1.62, horizontal: 1.96, vertikal: 1.18

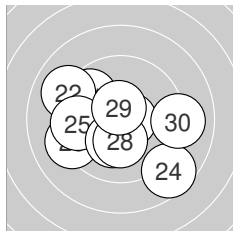

Serie 3: 96.8 (93)

9.7 ↘	9.0 ↘	9.2 ↙	8.6 ↘	9.5 ←
10.7* →	10.2* ↓	10.2* ↓	10.6* ↑	9.1 →

beste Teiler: 73.1 (26.), 95.0 (29.), 177.0 (28.)
 Trefferlage: 0.57 mm links, 0.51 mm tief
 Streuwert: 2.62, horizontal: 3.15, vertikal: 1.96

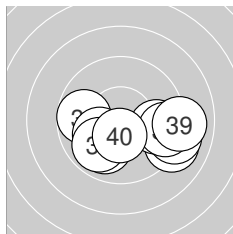

Serie 4: 96.4 (92)

9.9 ↙	9.1 ↘	9.8 →	9.7 ←	10.1 ↙
9.1 →	9.4 →	9.9 ↙	9.0 →	10.4* ↓

beste Teiler: 127.2 (40.), 209.4 (35.), 253.3 (31.)
 Trefferlage: 1.22 mm rechts, 1.14 mm tief
 Streuwert: 2.25, horizontal: 3.08, vertikal: 0.81



Ergebnis: **603.9** (578)
 Serien: 99.6 96.7 100.7 102.0 102.6 102.3
 Zähler: 38 22 0 0 0 0 0 0 0 0
 Innenzehner: 35
 Weitester: 478 (11.), 467 (1.), 458 (12.)
 beste Teiler: 44.9 (6.), 55.1 (22.), 73.2 (49.)
 Trefferlage: 0.09 mm rechts, 0.41 mm hoch
 Streuwert: 1.76, horizontal: 2.09, vertikal: 1.36

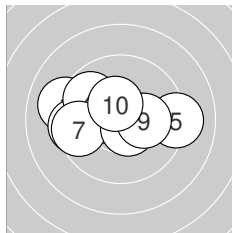
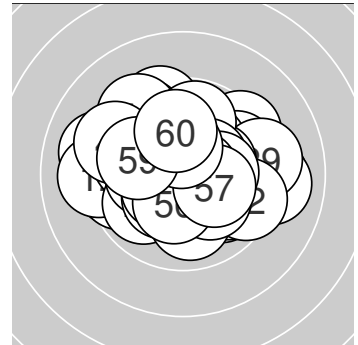

Serie 1: 99.6 (95)

9.1 ←	9.5 ←	10.5* →	9.8 ↘	9.1 →
10.8* ←	9.6 ←	10.6* ↘	10.2* →	10.4* ↑

beste Teiler: 44.9 (6.), 97.4 (8.), 114.0 (3.)
 Trefferlage: 0.67 mm links, 0.18 mm hoch
 Streuwert: 2.11, horizontal: 2.85, vertikal: 0.87

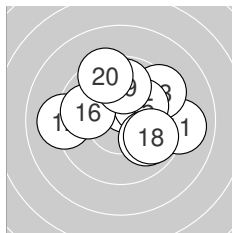

Serie 2: 96.7 (92)

9.0 →	9.1 ←	9.4 ↗	10.4* ↑	10.1 ↗
9.8 ←	9.9 ↘	9.8 ↘	9.8 ↑	9.4 ↑

beste Teiler: 131.5 (14.), 203.9 (15.), 254.4 (17.)
 Trefferlage: 0.63 mm rechts, 0.84 mm hoch
 Streuwert: 2.34, horizontal: 2.82, vertikal: 1.72

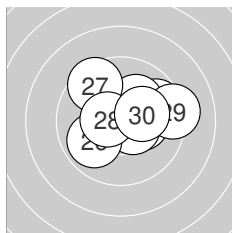

Serie 3: 100.7 (96)

9.7 ↗	10.7* ↗	10.3* →	10.5* ↘	10.2* ↗
9.9 ↗	9.5 ↘	10.5* ←	9.2 →	10.2* ↗

beste Teiler: 55.1 (22.), 107.9 (28.), 111.8 (24.)
 Trefferlage: 0.79 mm rechts, 0.54 mm hoch
 Streuwert: 1.70, horizontal: 2.08, vertikal: 1.22

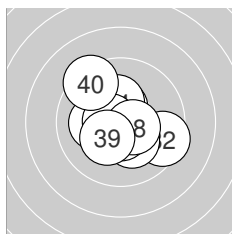

Serie 4: 102.0 (98)

10.2* ←	9.5 ↘	10.5* ↑	10.3* ↑	10.2* ↘
10.6* ↓	10.6* ←	10.5* ↘	10.3* ↗	9.3 ↘

beste Teiler: 88.3 (37.), 91.1 (36.), 108.4 (38.)
 Trefferlage: 0.13 mm links, 0.05 mm hoch
 Streuwert: 1.61, horizontal: 1.68, vertikal: 1.53

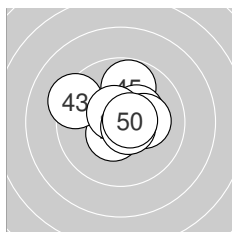

Serie 5: 102.6 (98)

10.4* ↑	10.5* ↗	9.3 ↘	10.2* ↑	9.8 ↑
10.3* ↗	10.2* →	10.6* ↘	10.7* ↘	10.6* →

beste Teiler: 73.2 (49.), 78.2 (50.), 91.0 (48.)
 Trefferlage: 0.15 mm rechts, 0.80 mm hoch
 Streuwert: 1.35, horizontal: 1.54, vertikal: 1.13

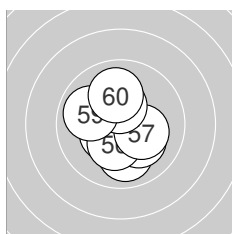

Serie 6: 102.3 (99)

10.3* ↑	10.6* ↘	10.0 ↓	10.4* ↗	10.2* ↘
10.3* ↓	10.2* ↘	10.4* ↑	9.9 ←	10.0 ↑

beste Teiler: 89.8 (52.), 137.0 (54.), 147.2 (58.)
 Trefferlage: 0.17 mm links, 0.03 mm hoch
 Streuwert: 1.41, horizontal: 1.20, vertikal: 1.59



LG 60 ZR

StandNr: 117

Patka-Rangger,, Patricia #70108009**Frauen**

Wertung

StartNr: 74

11.01.2025 15:52

SG_Mieming

Ergebnis: **612.9** (587)
 Serien: 102.8 103.4 101.0 102.5 99.7 103.5
 Zähler: 48 11 1 0 0 0 0 0 0 0
 Innenzehner: 40
 Weitestе: 655 (48.), 485 (27.), 446 (45.)
 beste Teiler: 34.5 (6.), 39.3 (52.), 42.0 (12.)
 Trefferlage: 0.15 mm rechts, 0.65 mm hoch
 Streuwert: 1.49, horizontal: 1.52, vertikal: 1.45

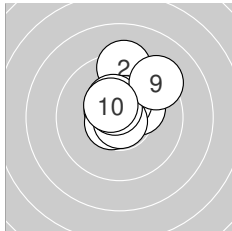
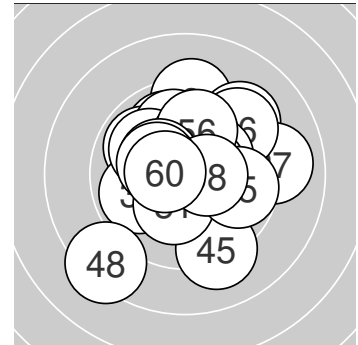
**Serie 1: 102.8 (98)**

10.6* ↘	9.3 ↑	10.6* ↙	10.3* ↗	10.4* ↑
10.8* ↓	10.4* ↗	10.6* ↘	9.3 ↗	10.5* ↘

beste Teiler: 34.5 (6.), 79.3 (3.), 84.5 (8.)
 Trefferlage: 0.24 mm rechts, 1.17 mm hoch
 Streuwert: 1.30, horizontal: 1.21, vertikal: 1.38

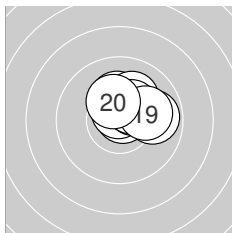
**Serie 2: 103.4 (99)**

9.9 →	10.8* ↗	10.5* ↑	10.7* ↑	10.2* ↑
10.4* ↗	10.1 ↑	10.4* ↗	10.1 →	10.3* ↗

beste Teiler: 42.0 (12.), 72.6 (14.), 109.1 (13.)
 Trefferlage: 0.78 mm rechts, 1.01 mm hoch
 Streuwert: 0.83, horizontal: 1.04, vertikal: 0.56

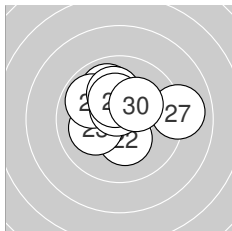
**Serie 3: 101.0 (97)**

10.6* ↑	10.3* ↓	10.1 ↙	9.9 ↘	9.9 ↘
10.1 ↑	9.0 →	10.6* ↑	10.3* ↑	10.2* ↗

beste Teiler: 88.3 (28.), 95.2 (21.), 160.3 (29.)
 Trefferlage: 0.05 mm rechts, 0.87 mm hoch
 Streuwert: 1.65, horizontal: 2.00, vertikal: 1.22

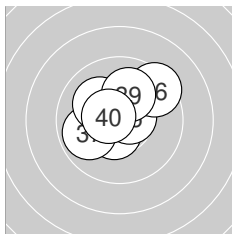
**Serie 4: 102.5 (98)**

10.5* ↘	10.6* ↑	10.4* ↗	10.3* ↘	10.6* ↗
9.4 ↗	9.9 ↙	10.1 ↘	10.1 ↑	10.6* ↙

beste Teiler: 86.0 (35.), 92.6 (32.), 96.4 (40.)
 Trefferlage: 0.17 mm links, 0.74 mm hoch
 Streuwert: 1.37, horizontal: 1.54, vertikal: 1.17

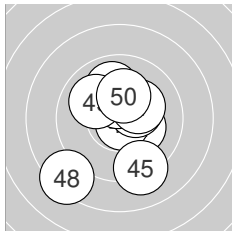
**Serie 5: 99.7 (96)**

10.3* ↘	10.8* ↓	9.9 ↑	10.4* ↗	9.2 ↓
10.4* ↑	10.2* ↗	8.3 ↙	10.0 ↘	10.2* ↑

beste Teiler: 47.0 (42.), 138.8 (46.), 146.6 (44.)
 Trefferlage: 0.03 mm links, 0.15 mm tief
 Streuwert: 2.22, horizontal: 1.92, vertikal: 2.49

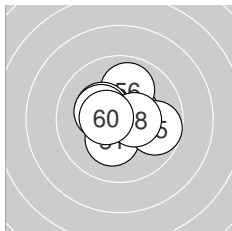
**Serie 6: 103.5 (99)**

10.3* ↘	10.8* ↑	10.6* ↘	10.5* ↗	9.7 →
10.0 ↑	10.3* ↘	10.5* →	10.3* ↙	10.5* ↙

beste Teiler: 39.3 (52.), 89.0 (53.), 110.7 (60.)
 Trefferlage: 0.07 mm rechts, 0.28 mm hoch
 Streuwert: 1.25, horizontal: 1.42, vertikal: 1.05

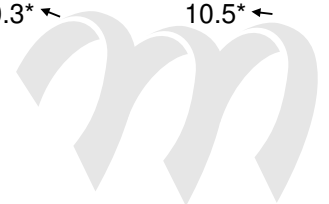

Ergebnis: 407.3 (386)
Serien: 100.9 102.4 104.0 100.0
Zähler: 26 14 0 0 0 0 0 0 0 0
Innenzehner: 21
Weiteste: 396 (35.), 390 (36.), 352 (7.)
beste Teiler: 27.0 (31.), 30.4 (15.), 40.3 (12.)
Trefferlage: 0.31 mm rechts, 0.56 mm tief
Streuwert: 1.49, horizontal: 1.67, vertikal: 1.29

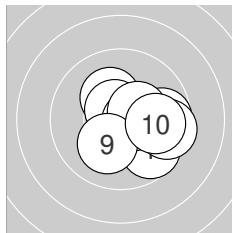
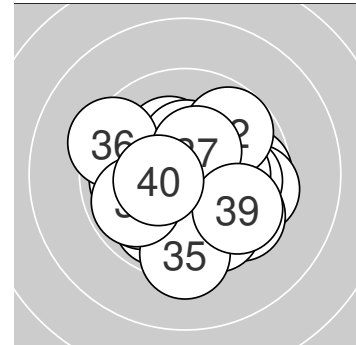

Serie 1: 100.9 (96)

9.7 ↘	10.2* ↖	10.2* →	9.7 →	10.6* ↖
10.6* →	9.5 →	10.4* →	10.1 ↙	9.9 →

beste Teiler: 83.5 (5.), 85.0 (6.), 138.2 (8.)
Trefferlage: 1.32 mm rechts, 0.22 mm tief
Streuwert: 1.40, horizontal: 1.62, vertikal: 1.14

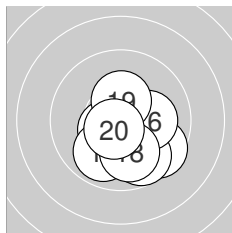

Serie 2: 102.4 (97)

9.6 ↘	10.8* ↓	9.7 ↘	10.5* ↙	10.8* ↘
10.1 →	9.9 ↙	10.0 ↓	10.4* ↑	10.6* ↙

beste Teiler: 30.4 (15.), 40.3 (12.), 82.2 (20.)
Trefferlage: 0.45 mm rechts, 0.99 mm tief
Streuwert: 1.31, horizontal: 1.30, vertikal: 1.31

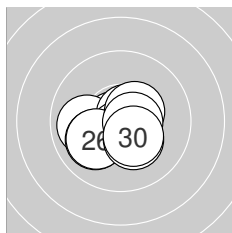

Serie 3: 104.0 (99)

10.8* ←	9.9 ←	10.0 ↙	10.7* ↗	10.7* ↓
10.1 ↙	10.5* ↗	10.3* ↘	10.6* →	10.4* ↘

beste Teiler: 50.0 (21.), 65.9 (24.), 73.4 (25.)
Trefferlage: 0.25 mm links, 0.51 mm tief
Streuwert: 1.11, horizontal: 1.36, vertikal: 0.78

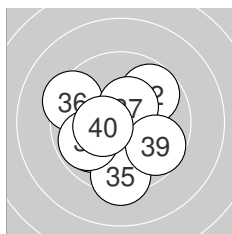

Serie 4: 100.0 (94)

10.8* →	9.8 ↗	10.4* ↘	9.9 ↙	9.4 ↓
9.4 ↖	10.4* ↗	9.8 ↙	9.7 ↘	10.4* ↖

beste Teiler: 27.0 (31.), 127.4 (37.), 135.5 (40.)
Trefferlage: 0.27 mm links, 0.51 mm tief
Streuwert: 1.92, horizontal: 2.02, vertikal: 1.81



Ergebnis: **412.2** (394)
 Serien: 103.4 103.0 103.1 102.7
 Zähler: 34 6 0 0 0 0 0 0 0 0
 Innenzehner: 27
 Weitester: 364 (1.), 289 (18.), 280 (30.)
 beste Teiler: 31.7 (9.), 37.6 (8.), 42.7 (19.)
 Trefferlage: 0.22 mm rechts, 0.05 mm tief
 Streuwert: 1.28, horizontal: 1.52, vertikal: 0.97

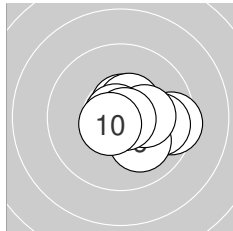
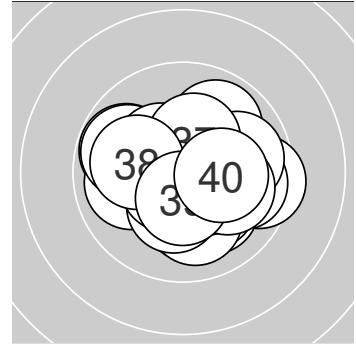

Serie 1: 103.4 (98)

9.5 →	9.8 →	10.4* ↘	10.6* ↑	10.5* ↗
10.1 ↘	10.3* →	10.8* ↖	10.8* →	10.6* ↖

beste Teiler: 31.7 (9.), 37.6 (8.), 84.5 (4.)
 Trefferlage: 1.05 mm rechts, 0.22 mm tief
 Streuwert: 1.12, horizontal: 1.37, vertikal: 0.78

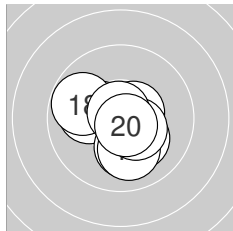

Serie 2: 103.0 (99)

10.4* ↖	10.0 ←	10.1 ↓	10.2* ↘	10.0 ↓
10.6* ↗	10.4* ↘	9.8 ↖	10.8* ↗	10.7* ↘

beste Teiler: 42.7 (19.), 63.4 (20.), 98.4 (16.)
 Trefferlage: 0.18 mm links, 0.43 mm tief
 Streuwert: 1.29, horizontal: 1.42, vertikal: 1.14

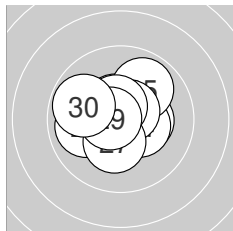

Serie 3: 103.1 (98)

10.0 ←	10.5* ↗	10.3* →	10.4* →	9.9 ↗
10.6* ↗	10.3* ↓	10.6* ↗	10.7* ←	9.8 ↖

beste Teiler: 74.1 (29.), 80.6 (26.), 97.7 (28.)
 Trefferlage: 0.19 mm links, 0.29 mm hoch
 Streuwert: 1.30, horizontal: 1.51, vertikal: 1.05

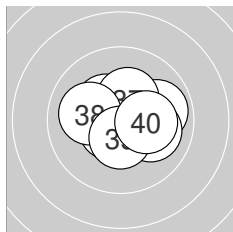

Serie 4: 102.7 (99)

10.6* ↖	10.2* ↖	10.4* ↘	9.9 →	10.5* →
10.0 →	10.3* ↑	10.1 ←	10.5* ↓	10.2* →

beste Teiler: 96.6 (31.), 101.0 (35.), 125.0 (39.)
 Trefferlage: 0.23 mm rechts, 0.14 mm hoch
 Streuwert: 1.32, horizontal: 1.66, vertikal: 0.86



AR 40

StandNr: 119

Entner,, Amita #70425183

Frauen

Wertung

StartNr: 76

11.01.2025 15:15

SG_Wörgl

Ergebnis: **419.9** (399)
 Serien: 105.4 105.1 104.4 105.0
 Zähler: 39 1 0 0 0 0 0 0 0 0
 Innenzehner: 37
 Weitestе: 255 (26.), 225 (39.), 206 (14.)
 beste Teiler: 15.2 (8.), 25.9 (19.), 33.1 (13.)
 Trefferlage: 0.12 mm rechts, 0.05 mm tief
 Streuwert: 0.90, horizontal: 1.02, vertikal: 0.76

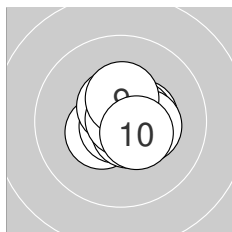
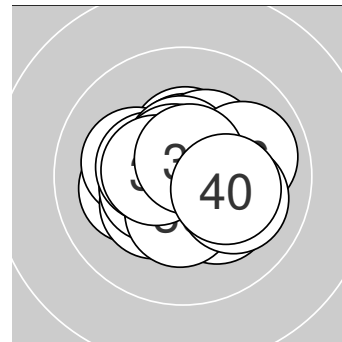

Serie 1: 105.4 (100)

10.4* ↙	10.4* →	10.8* ↘	10.6* ↓	10.5* →
10.6* ↘	10.3* →	10.9* ↗	10.4* ↑	10.5* ↘

beste Teiler: 15.2 (8.), 42.4 (3.), 77.0 (4.)
 Trefferlage: 0.34 mm rechts, 0.03 mm hoch
 Streuwert: 0.77, horizontal: 0.84, vertikal: 0.70

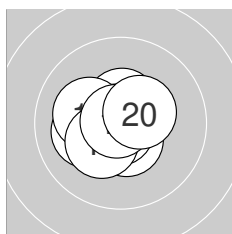

Serie 2: 105.1 (100)

10.6* ↗	10.5* ↑	10.8* ↖	10.1 ←	10.5* ↓
10.8* ↓	10.2* ↖	10.3* ↘	10.9* ↖	10.4* ↗

beste Teiler: 25.9 (19.), 33.1 (13.), 40.2 (16.)
 Trefferlage: 0.34 mm links, 0.01 mm hoch
 Streuwert: 0.91, horizontal: 1.05, vertikal: 0.74

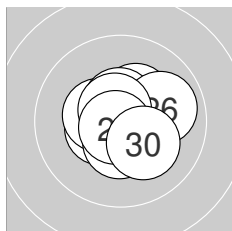

Serie 3: 104.4 (99)

10.5* ↙	10.8* ↖	10.4* ↖	10.3* ↗	10.5* ↑
9.9 →	10.4* ↓	10.6* ↘	10.8* ↘	10.2* ↘

beste Teiler: 47.4 (22.), 49.6 (29.), 77.8 (28.)
 Trefferlage: 0.09 mm rechts, 0.09 mm hoch
 Streuwert: 1.05, horizontal: 1.16, vertikal: 0.92

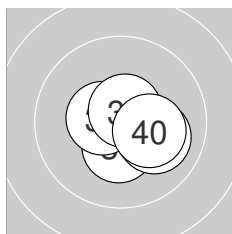

Serie 4: 105.0 (100)

10.6* ↓	10.7* ↖	10.8* ↗	10.4* →	10.6* ↓
10.4* ↓	10.5* ↖	10.7* ↗	10.1 →	10.2* →

beste Teiler: 50.4 (33.), 56.4 (32.), 74.0 (38.)
 Trefferlage: 0.38 mm rechts, 0.36 mm tief
 Streuwert: 0.87, horizontal: 1.00, vertikal: 0.71



Ergebnis: **412.6** (393)
 Serien: 101.6 104.5 103.1 103.4
 Zähler: 33 7 0 0 0 0 0 0 0 0
 Innenzehner: 30
 Weitester: 456 (16.), 362 (34.), 319 (24.)
 beste Teiler: 28.4 (12.), 37.8 (39.), 43.0 (13.)
 Trefferlage: 0.03 mm links, 0.08 mm hoch
 Streuwert: 1.32, horizontal: 1.53, vertikal: 1.07

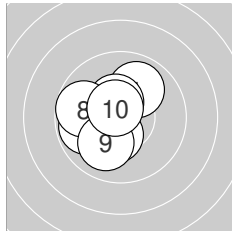
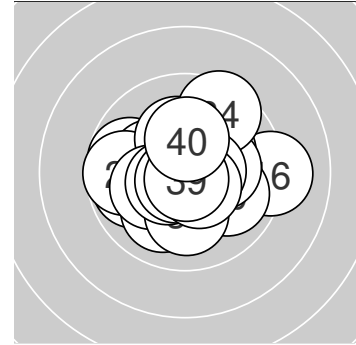

Serie 1: 101.6 (97)

9.9 ↗	10.4* ↖	10.5* ←	10.4* ↓	10.2* ←
10.1 ←	9.8 ←	9.7 ←	10.0 ↓	10.6* ↖

beste Teiler: 85.2 (10.), 122.7 (3.), 126.4 (2.)
 Trefferlage: 1.15 mm links, 0.06 mm tief
 Streuwert: 1.27, horizontal: 1.23, vertikal: 1.30

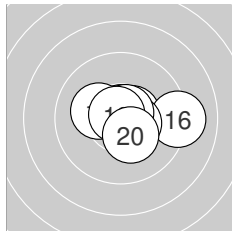

Serie 2: 104.5 (99)

10.7* →	10.8* →	10.8* ↑	10.6* →	10.2* ←
9.1 →	10.5* ↘	10.7* ↗	10.8* ↖	10.3* ↓

beste Teiler: 28.4 (12.), 43.0 (13.), 43.1 (19.)
 Trefferlage: 0.65 mm rechts, 0.04 mm hoch
 Streuwert: 1.19, horizontal: 1.59, vertikal: 0.57

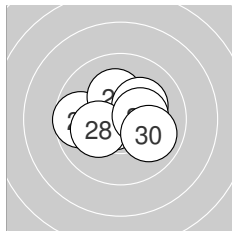

Serie 3: 103.1 (98)

10.4* ←	10.7* ←	10.8* ↘	9.7 ←	10.7* ↗
10.2* ↖	10.2* ↗	10.2* ←	10.3* →	9.9 ↘

beste Teiler: 44.9 (23.), 53.4 (25.), 62.9 (22.)
 Trefferlage: 0.21 mm links, 0.16 mm hoch
 Streuwert: 1.33, horizontal: 1.69, vertikal: 0.84

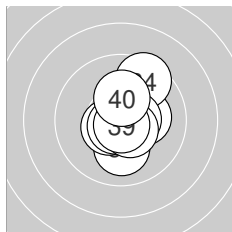

Serie 4: 103.4 (99)

10.1 ↓	10.3* ↗	10.2* →	9.5 ↗	10.5* ←
10.5* →	10.7* ↗	10.5* ↘	10.8* ↓	10.3* ↑

beste Teiler: 37.8 (39.), 62.2 (37.), 101.1 (36.)
 Trefferlage: 0.56 mm rechts, 0.19 mm hoch
 Streuwert: 1.24, horizontal: 0.93, vertikal: 1.48



Ergebnis: **193.1** (184)
 Serien: 97.4 95.7
 Zähler: 6 12 2 0 0 0 0 0 0 0
 Innenzehner: 4
 Weitester: 749 (1.), 635 (19.), 462 (4.)
 beste Teiler: 12.3 (2.), 87.8 (3.), 113.2 (9.)
 Trefferlage: 1.12 mm rechts, 0.74 mm hoch
 Streuwert: 2.48, horizontal: 2.24, vertikal: 2.71

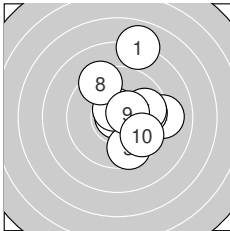
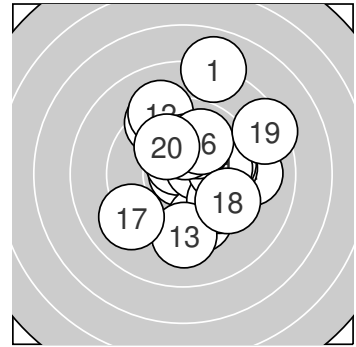

Serie 1: 97.4 (92)

8.0 ↑ 10.9* ← 10.6* ↖
 9.8 → 9.8 → 9.4 ↘

9.1 → 9.6 ↓
 10.5* ↗ 9.7 ↘

beste Teiler: 12.3 (2.), 87.8 (3.), 113.2 (9.)
 Trefferlage: 1.48 mm rechts, 0.83 mm hoch
 Streuwert: 2.40, horizontal: 1.88, vertikal: 2.83

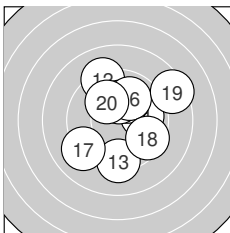

Serie 2: 95.7 (92)

9.9 → 9.2 ↖ 9.3 ↓
 9.9 ↗ 9.1 ↙ 9.5 ↘

10.1 ↗ 10.2* ↑
 8.4 ↗ 10.1 ↖

beste Teiler: 187.6 (15.), 218.3 (20.), 220.1 (14.)
 Trefferlage: 0.75 mm rechts, 0.65 mm hoch
 Streuwert: 2.67, horizontal: 2.59, vertikal: 2.74



Ergebnis: **189.6** (180)
 Serien: 92.0 97.6
 Zähler: 6 9 4 1 0 0 0 0 0 0 0
 Innenzehner: 4
 Weitesten: 839 (9.), 669 (7.), 613 (14.)
 beste Teiler: 52.0 (12.), 75.2 (15.), 95.6 (10.)
 Trefferlage: 0.06 mm links, 0.28 mm tief
 Streuwert: 3.04, horizontal: 3.93, vertikal: 1.74

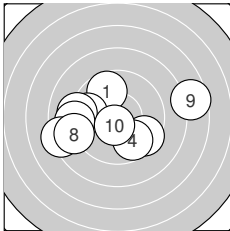
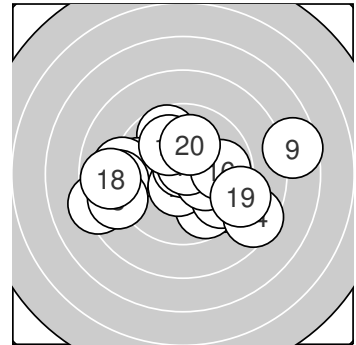

Serie 1: 92.0 (87)

9.7 ↗	9.6 ←	9.5 ↘	9.7 ↘	9.1 ←
9.0 ←	8.3 ←	8.9 ←	7.6 →	10.6* ↓

beste Teiler: 95.6 (10.), 305.3 (4.), 313.4 (1.)
 Trefferlage: 1.25 mm links, 0.42 mm tief
 Streuwert: 3.44, horizontal: 4.50, vertikal: 1.85

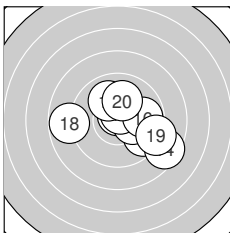

Serie 2: 97.6 (93)

9.6 ↘	10.7* ↑	10.3* →	8.5 ↘	10.7* ↑
9.8 →	10.0 ↗	8.8 ←	9.1 →	10.1 ↑

beste Teiler: 52.0 (12.), 75.2 (15.), 174.1 (13.)
 Trefferlage: 1.12 mm rechts, 0.15 mm tief
 Streuwert: 2.46, horizontal: 3.03, vertikal: 1.72



Ergebnis: **195.3** (186)
 Serien: 97.0 98.3
 Zähler: 9 8 3 0 0 0 0 0 0 0 0
 Innenzehner: 8
 Weitesten: 559 (16.), 504 (6.), 503 (10.)
 beste Teiler: 111.3 (14.), 142.0 (13.), 148.0 (17.)
 Trefferlage: 0.07 mm links, 0.79 mm hoch
 Streuwert: 2.30, horizontal: 2.70, vertikal: 1.81

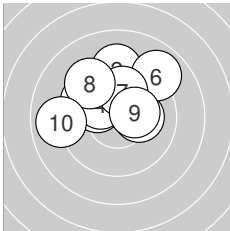
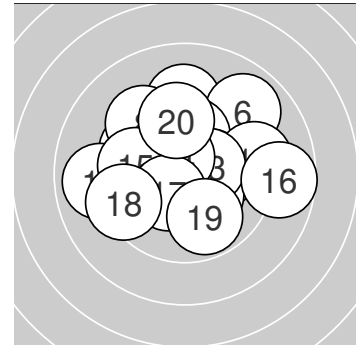

Serie 1: 97.0 (93)

9.7 ↖	9.2 ↑	10.2* ↖	10.2* ↖	10.2* →
8.9 ↗	10.0 ↑	9.4 ↘	10.3* →	8.9 ←

beste Teiler: 157.6 (9.), 190.0 (5.), 191.4 (4.)
 Trefferlage: 0.64 mm links, 1.67 mm hoch
 Streuwert: 2.12, horizontal: 2.55, vertikal: 1.58

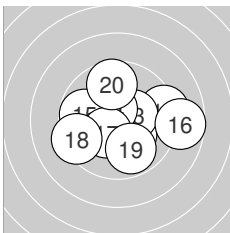

Serie 2: 98.3 (93)

9.3 →	10.3* ↘	10.4* →	10.5* ↖	9.8 ←
8.7 →	10.4* ↗	9.4 ←	9.8 ↘	9.7 ↑

beste Teiler: 111.3 (14.), 142.0 (13.), 148.0 (17.)
 Trefferlage: 0.48 mm rechts, 0.08 mm tief
 Streuwert: 2.33, horizontal: 2.86, vertikal: 1.64



Ergebnis: **198.7** (190)
 Serien: 99.3 99.4
 Zähler: 11 8 1 0 0 0 0 0 0 0
 Innenzehner: 6
 Weitesten: 697 (17.), 468 (5.), 354 (15.)
 beste Teiler: 15.8 (14.), 98.8 (3.), 115.2 (13.)
 Trefferlage: 0.54 mm links, 0.48 mm tief
 Streuwert: 2.05, horizontal: 2.71, vertikal: 1.04

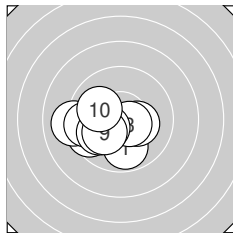
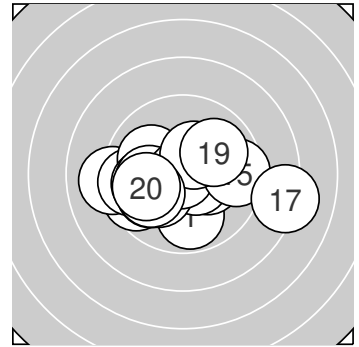

Serie 1: 99.3 (95)

9.8 ↓ 10.3* → 10.6* ↘
 10.3* ↙ 9.6 ← 9.9 ↙
 beste Teiler: 98.8 (3.), 156.4 (6.), 169.7 (2.)
 Trefferlage: 1.53 mm links, 0.84 mm tief
 Streuwert: 1.58, horizontal: 2.01, vertikal: 0.97

9.6 ↙ 9.1 ←
 10.1 ↙ 10.0 ↘

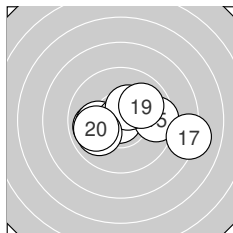

Serie 2: 99.4 (95)

9.9 ← 10.1 ← 10.5* ↗
 10.4* ↗ 8.2 → 10.0 ↙
 beste Teiler: 15.8 (14.), 115.2 (13.), 145.1 (16.)
 Trefferlage: 0.44 mm rechts, 0.11 mm tief
 Streuwert: 2.28, horizontal: 3.05, vertikal: 1.04

10.9* ↙ 9.5 →
 10.0 ↗ 9.9 ↙



Ergebnis: **195.8** (188)
 Serien: 98.9 96.9
 Zähler: 8 12 0 0 0 0 0 0 0 0
 Innenzehner: 5
 Weitester: 490 (15.), 484 (13.), 470 (19.)
 beste Teiler: 126.7 (14.), 132.2 (9.), 161.0 (12.)
 Trefferlage: 0.06 mm rechts, 0.65 mm hoch
 Streuwert: 2.22, horizontal: 2.52, vertikal: 1.87

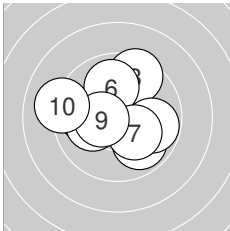
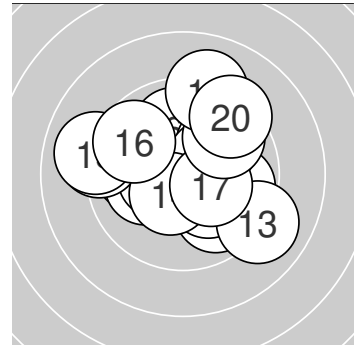

Serie 1: 98.9 (94)

9.9 ← 9.9 ↘ 9.5 ↗
 9.9 ↑ 10.2* ↘ 10.1 ←
 beste Teiler: 132.2 (9.), 185.5 (7.), 206.4 (4.)
 Trefferlage: 0.56 mm links, 0.24 mm hoch
 Streuwert: 2.02, horizontal: 2.34, vertikal: 1.64

10.1 ← 9.8 →
 10.4* ← 9.1 ←

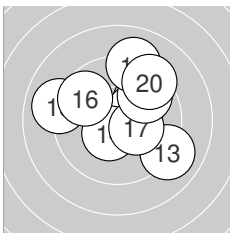

Serie 2: 96.9 (94)

10.0 ↗ 10.3* ↗ 9.0 ↘
 9.7 ↘ 10.3* ↘ 9.8 ↗
 beste Teiler: 126.7 (14.), 161.0 (12.), 164.3 (17.)
 Trefferlage: 0.68 mm rechts, 1.06 mm hoch
 Streuwert: 2.38, horizontal: 2.65, vertikal: 2.08

10.4* ↗ 9.0 ←
 9.1 ↑ 9.3 ↗



Ergebnis: **295** (311.1)
Serien: 69 73 75 78
Zähler: 3 7 12 4 11 1 1 1 0 0 0
Innenzehner: 1
Weiteste: 6208 (23.), 5563 (8.), 4182 (16.)
beste Teiler: 457.2 (4.), 589.2 (37.), 754.9 (13.)
Trefferlage: 7.04 mm rechts, 8.34 mm hoch
Streuwert: 18.81, horizontal: 18.55, vertikal: 19.07

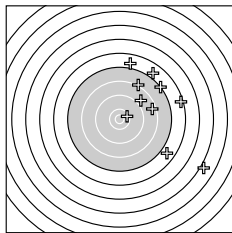
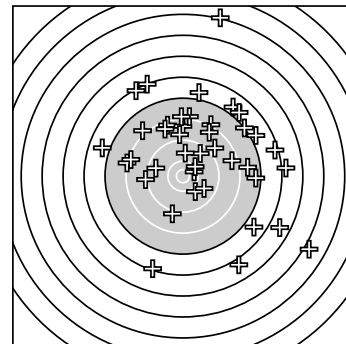

Serie 1: 69 (74.2)

6.9 ↑	8.5 →	6.8 ↘	10.4* →	6.9 ↗
8.9 ↗	8.2 ↗	4.0 ↘	7.2 ↗	6.4 →

beste Teiler: 457.2 (4.), 1620.4 (6.), 1960.5 (2.)
Trefferlage: 20.48 mm rechts, 7.71 mm hoch
Streuwert: 16.53, horizontal: 13.63, vertikal: 19.00

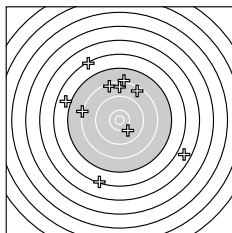

Serie 2: 73 (77.0)

8.2 ←	6.3 ↓	10.0 ↘	8.4 ↑	8.6 ↑
5.7 ↘	8.5 ↗	6.9 ←	6.3 ↘	8.1 ↑

beste Teiler: 754.9 (13.), 1906.0 (15.), 1951.4 (17.)
Trefferlage: 3.34 mm links, 6.55 mm hoch
Streuwert: 20.08, horizontal: 19.08, vertikal: 21.03

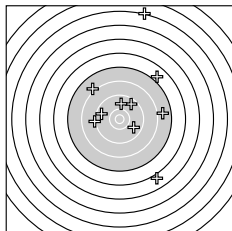

Serie 3: 75 (80.0)

7.8 →	6.0 ↘	3.2 ↑	9.6 ↗	8.1 ↘
9.8 ↑	6.9 ↗	9.8 ↘	9.6 ←	9.2 ←

beste Teiler: 884.2 (26.), 932.1 (28.), 1079.0 (29.)
Trefferlage: 5.71 mm rechts, 8.61 mm hoch
Streuwert: 20.00, horizontal: 15.12, vertikal: 23.91

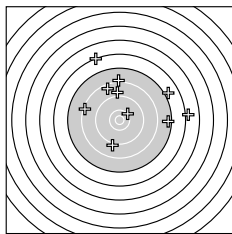

Serie 4: 78 (79.9)

6.0 →	7.0 ↗	8.5 ↑	9.1 ↓	9.0 ↑
7.5 →	10.2 ↗	8.3 ←	6.2 ↘	8.1 ↑

beste Teiler: 589.2 (37.), 1492.9 (34.), 1589.1 (35.)
Trefferlage: 5.32 mm rechts, 10.50 mm hoch
Streuwert: 17.01, horizontal: 19.66, vertikal: 13.86



Ergebnis: 386.3 (369)
Serien: 99.1 94.5 94.2 98.5
Zähler: 16 20 1 3 0 0 0 0 0 0
Innenzehner: 13
Weiteste: 832 (25.), 823 (23.), 783 (11.)
beste Teiler: 57.3 (30.), 80.2 (24.), 81.0 (8.)
Trefferlage: 0.28 mm rechts, 0.27 mm hoch
Streuwert: 2.68, horizontal: 2.93, vertikal: 2.40

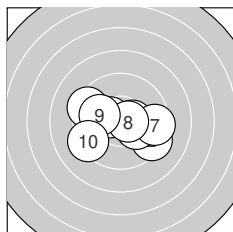
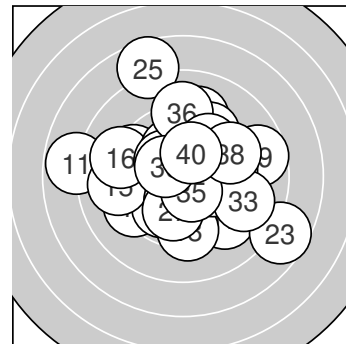

Serie 1: 99.1 (95)
 10.5* ← 9.4 ↘ 10.4* → 9.9 ← 10.2* ↘
 9.4 ← 9.4 → 10.6* → 10.0 ← 9.3 ↗
beste Teiler: 81.0 (8.), 122.7 (1.), 129.1 (3.)
Trefferlage: 0.22 mm links, 0.20 mm tief
Streuwert: 2.14, horizontal: 2.78, vertikal: 1.20

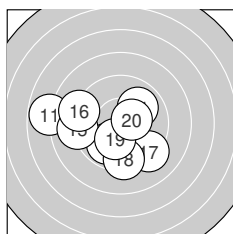

Serie 2: 94.5 (90)
 7.8 ← 9.9 ↗ 9.5 ↓ 9.9 ↗ 9.1 ←
 9.1 ← 9.2 ↘ 9.4 ↓ 10.2* ↓ 10.4* →
beste Teiler: 128.0 (20.), 184.0 (19.), 252.7 (14.)
Trefferlage: 1.21 mm links, 1.07 mm tief
Streuwert: 2.85, horizontal: 3.43, vertikal: 2.11

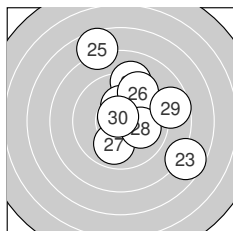

Serie 3: 94.2 (89)
 9.2 ↑ 10.3* ↑ 7.7 ↘ 10.6* ↗ 7.6 ↑
 9.5 ↗ 9.9 ↓ 10.0 → 8.7 → 10.7* ↗
beste Teiler: 57.3 (30.), 80.2 (24.), 167.1 (22.)
Trefferlage: 1.49 mm rechts, 1.21 mm hoch
Streuwert: 3.17, horizontal: 2.89, vertikal: 3.43

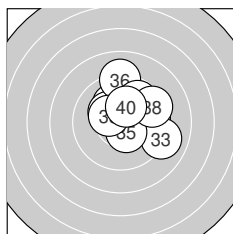

Serie 4: 98.5 (95)
 10.1 ↘ 9.7 → 9.0 → 10.3* ↘ 10.5* ↘
 9.1 ↑ 9.8 ↗ 9.4 → 10.4* ↘ 10.2* ↑
beste Teiler: 125.3 (35.), 145.8 (39.), 173.8 (34.)
Trefferlage: 1.06 mm rechts, 1.17 mm hoch
Streuwert: 1.94, horizontal: 2.08, vertikal: 1.80



Ergebnis: 405.5 (389)
Serien: 102.4 102.0 100.9 100.2
Zähler: 30 9 1 0 0 0 0 0 0 0
Innenzehner: 22
Weiteste: 591 (38.), 453 (33.), 427 (17.)
beste Teiler: 48.8 (3.), 59.6 (16.), 63.1 (14.)
Trefferlage: 0.03 mm links, 0.37 mm hoch
Streuwert: 1.67, horizontal: 1.85, vertikal: 1.46

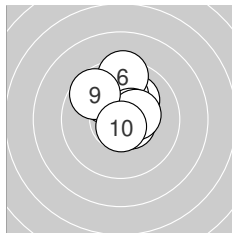
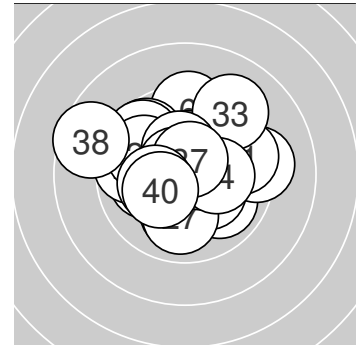

Serie 1: 102.4 (98)

10.1 ↗	10.6* ↘	10.8* ↗	10.1 ↖	10.1 ↑
9.4 ↑	10.5* ↗	10.4* →	9.7 ↖	10.7* ↓

beste Teiler: 48.8 (3.), 64.1 (10.), 93.9 (2.)
Trefferlage: 0.17 mm rechts, 1.17 mm hoch
Streuwert: 1.27, horizontal: 1.14, vertikal: 1.39

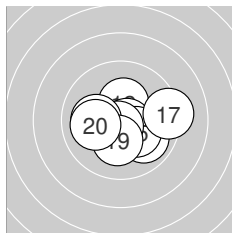

Serie 2: 102.0 (98)

10.6* ↓	10.3* ↑	9.9 ↘	10.7* ↘	10.3* ↘
10.7* ↓	9.2 →	10.1 ←	10.2* ↓	10.0 ←

beste Teiler: 59.6 (16.), 63.1 (14.), 100.0 (11.)
Trefferlage: 0.38 mm rechts, 0.44 mm tief
Streuwert: 1.52, horizontal: 1.91, vertikal: 0.99

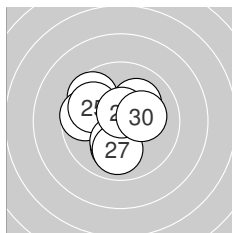

Serie 3: 100.9 (97)

10.0 ↓	10.6* ↙	9.6 ↖	9.7 ←	9.9 ↖
10.2* ↓	10.0 ↓	10.1 ↗	10.6* ↑	10.2* →

beste Teiler: 76.7 (29.), 89.8 (22.), 184.3 (26.)
Trefferlage: 0.63 mm links, 0.06 mm tief
Streuwert: 1.64, horizontal: 1.63, vertikal: 1.64

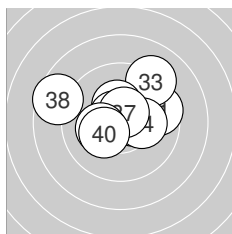

Serie 4: 100.2 (96)

9.6 →	10.6* →	9.1 ↗	10.2* →	10.3* ↑
10.7* ↖	10.6* ↑	8.6 ↖	10.2* ←	10.3* ↙

beste Teiler: 74.9 (36.), 90.7 (37.), 97.0 (32.)
Trefferlage: 0.05 mm links, 0.81 mm hoch
Streuwert: 2.05, horizontal: 2.56, vertikal: 1.34



Ergebnis: 406.1 (389)
Serien: 102.4 101.3 100.7 101.7
Zähler: 30 9 1 0 0 0 0 0 0 0
Innenzehner: 25
Weiteste: 648 (33.), 354 (16.), 353 (37.)
beste Teiler: 39.8 (36.), 46.0 (34.), 67.0 (17.)
Trefferlage: 0.34 mm links, 0.14 mm tief
Streuwert: 1.64, horizontal: 1.89, vertikal: 1.34

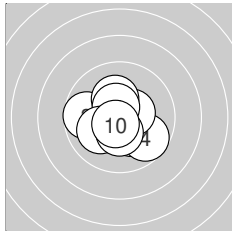
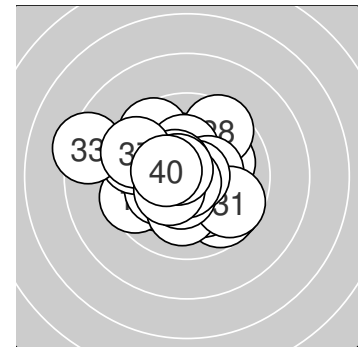

Serie 1: 102.4 (98)

10.4* ←	10.2* ↘	9.7 ←	9.7 ↘	10.5* →
10.2* ↑	10.5* ↑	10.1 ↙	10.4* ↓	10.7* ↘

beste Teiler: 74.9 (10.), 103.1 (7.), 120.5 (5.)
Trefferlage: 0.27 mm links, 0.37 mm tief
Streuwert: 1.40, horizontal: 1.59, vertikal: 1.18

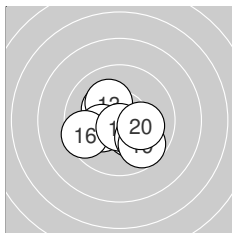

Serie 2: 101.3 (98)

10.3* ↘	10.3* ↖	10.2* ↖	10.2* ←	10.3* ↘
9.5 ←	10.7* ↓	10.0 ↘	9.7 ↘	10.1 →

beste Teiler: 67.0 (17.), 160.5 (11.), 173.4 (12.)
Trefferlage: 0.09 mm rechts, 0.68 mm tief
Streuwert: 1.56, horizontal: 1.85, vertikal: 1.19

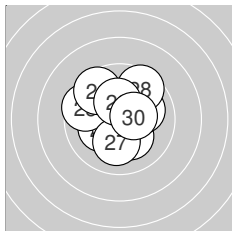

Serie 3: 100.7 (97)

10.2* ←	10.6* ↓	10.2* ↘	10.1 →	9.6 ←
9.6 ↖	10.1 ↓	9.6 ↗	10.3* ↑	10.4* →

beste Teiler: 88.9 (22.), 136.3 (30.), 165.2 (29.)
Trefferlage: 0.15 mm links, 0.40 mm hoch
Streuwert: 1.76, horizontal: 1.79, vertikal: 1.74

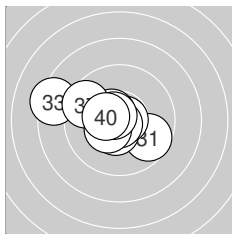

Serie 4: 101.7 (96)

9.7 ↘	10.5* ↓	8.4 ←	10.8* →	10.5* ↖
10.8* ↓	9.5 ↖	10.4* ↙	10.7* ↖	10.4* ←

beste Teiler: 39.8 (36.), 46.0 (34.), 73.2 (39.)
Trefferlage: 1.05 mm links, 0.07 mm hoch
Streuwert: 1.83, horizontal: 2.35, vertikal: 1.10



Ergebnis: 402.0 (383)
Serien: 101.1 102.8 97.6 100.5
Zähler: 26 11 3 0 0 0 0 0 0 0
Innenzehner: 22
Weiteste: 593 (30.), 522 (24.), 505 (29.)
beste Teiler: 32.2 (37.), 40.8 (21.), 52.2 (19.)
Trefferlage: 0.31 mm links, 0.07 mm tief
Streuwert: 1.88, horizontal: 2.32, vertikal: 1.30

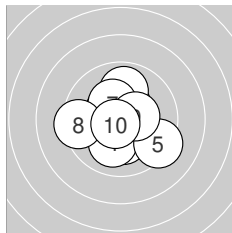
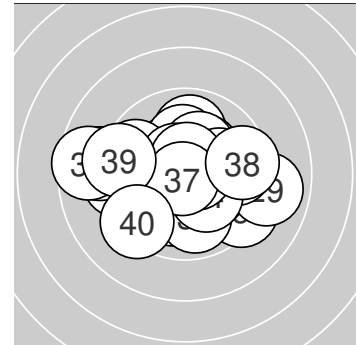

Serie 1: 101.1 (97)

10.4* ↗	9.9 ↑	10.2* ↓	10.1 ↓	9.3 ↘
10.4* ↘	10.3* ↘	9.4 ←	10.4* →	10.7* ↗

beste Teiler: 64.4 (10.), 128.8 (6.), 135.5 (1.)
Trefferlage: 0.08 mm links, 0.07 mm tief
Streuwert: 1.76, horizontal: 1.87, vertikal: 1.65

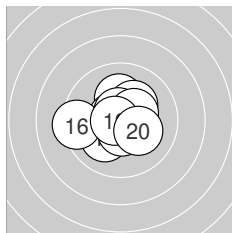

Serie 2: 102.8 (99)

10.2* ↑	10.6* ↘	10.2* ↗	10.1 ↗	10.5* ↓
9.3 ←	10.6* ↑	10.4* ↗	10.7* ←	10.2* ↘

beste Teiler: 52.2 (19.), 76.2 (17.), 76.3 (12.)
Trefferlage: 0.29 mm links, 0.10 mm hoch
Streuwert: 1.40, horizontal: 1.62, vertikal: 1.13

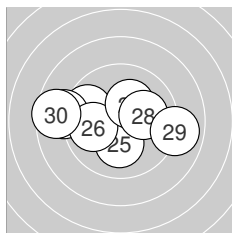

Serie 3: 97.6 (92)

10.8* ↓	10.4* ↗	9.7 ↘	8.9 ←	10.1 ↓
9.9 ←	10.2* ↗	10.1 →	8.9 →	8.6 ←

beste Teiler: 40.8 (21.), 149.3 (22.), 178.9 (27.)
Trefferlage: 1.03 mm links, 0.00 mm
Streuwert: 2.46, horizontal: 3.30, vertikal: 1.09

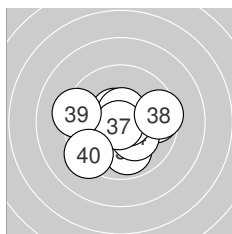

Serie 4: 100.5 (95)

9.7 →	10.5* ↘	9.9 ↓	10.2* ↘	10.7* →
10.6* ↑	10.8* ↗	9.5 →	9.3 ←	9.3 ↗

beste Teiler: 32.2 (37.), 65.1 (35.), 91.7 (36.)
Trefferlage: 0.16 mm rechts, 0.33 mm tief
Streuwert: 1.94, horizontal: 2.34, vertikal: 1.44



Ergebnis: 396.2 (377)
Serien: 96.5 100.0 100.3 99.4
Zähler: 22 13 5 0 0 0 0 0 0 0
Innenzehner: 17
Weiteste: 614 (9.), 579 (8.), 568 (38.)
beste Teiler: 32.2 (27.), 58.2 (13.), 63.1 (31.)
Trefferlage: 0.68 mm links, 0.27 mm hoch
Streuwert: 2.14, horizontal: 2.56, vertikal: 1.62

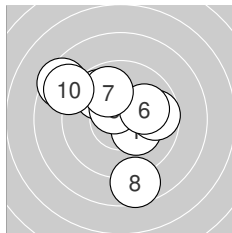
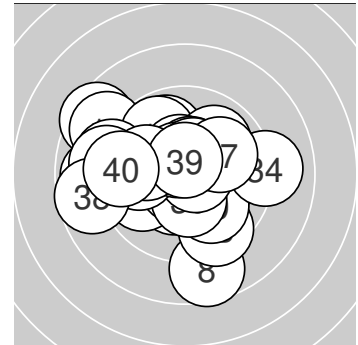

Serie 1: 96.5 (91)

10.3* ↘	10.4* ↖	9.8 ↘	9.7 →	10.5* ↖
10.0 →	9.9 ↖	8.6 ↓	8.5 ↘	8.8 ↘

beste Teiler: 109.9 (5.), 132.1 (2.), 169.4 (1.)
Trefferlage: 0.59 mm links, 0.74 mm hoch
Streuwert: 2.66, horizontal: 2.76, vertikal: 2.56

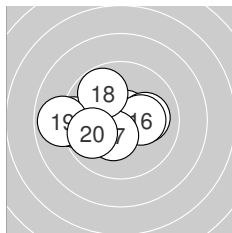

Serie 2: 100.0 (95)

10.3* ↖	10.6* →	10.7* ↗	10.1 →	9.3 ←
10.2* →	10.3* ↙	9.8 ↘	8.9 ←	9.8 ↙

beste Teiler: 58.2 (13.), 83.8 (12.), 151.2 (17.)
Trefferlage: 1.06 mm links, 0.10 mm hoch
Streuwert: 1.88, horizontal: 2.45, vertikal: 1.03

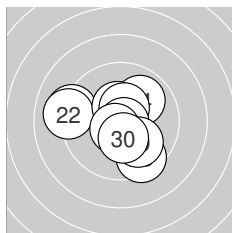

Serie 3: 100.3 (96)

9.2 ←	9.1 ←	9.5 ↘	9.9 ↗	10.4* ↖
10.5* ↖	10.8* ↘	10.6* ↙	10.0 ↘	10.3* ↓

beste Teiler: 32.2 (27.), 82.8 (28.), 122.2 (26.)
Trefferlage: 0.38 mm links, 0.14 mm tief
Streuwert: 2.02, horizontal: 2.33, vertikal: 1.65

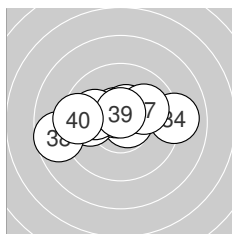

Serie 4: 99.4 (95)

10.7* →	9.9 ←	10.6* ↖	9.0 →	10.0 ←
10.5* ↖	10.0 →	8.7 ←	10.6* ↖	9.4 ←

beste Teiler: 63.1 (31.), 83.0 (39.), 95.2 (33.)
Trefferlage: 0.68 mm links, 0.40 mm hoch
Streuwert: 2.18, horizontal: 3.00, vertikal: 0.73



Ergebnis: 409.0 (393)
Serien: 102.9 101.2 101.1 103.8
Zähler: 33 7 0 0 0 0 0 0 0 0 0
Innenzehner: 28
Weiteste: 432 (38.), 410 (18.), 374 (22.)
beste Teiler: 30.2 (8.), 39.5 (39.), 48.2 (40.)
Trefferlage: 0.05 mm rechts, 0.02 mm hoch
Streuwert: 1.47, horizontal: 1.69, vertikal: 1.22

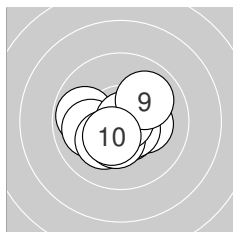
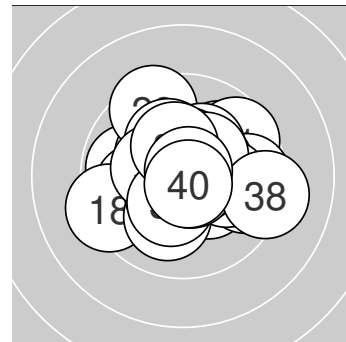

Serie 1: 102.9 (99)

10.2* →	9.8 ←	10.0 ←	10.6* ↘	10.2* ↙
10.5* ↘	10.4* ↓	10.8* →	10.0 ↗	10.4* ↙

beste Teiler: 30.2 (8.), 98.2 (4.), 101.4 (6.)
Trefferlage: 0.20 mm links, 0.41 mm tief
Streuwert: 1.29, horizontal: 1.57, vertikal: 0.93

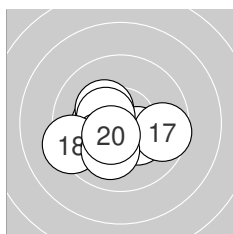

Serie 2: 101.2 (98)

10.3* ↘	10.3* ←	10.2* ↙	10.3* ↘	10.5* ↖
10.1 ↗	9.6 →	9.3 ←	10.1 ↓	10.5* ↙

beste Teiler: 117.2 (20.), 124.8 (15.), 153.0 (12.)
Trefferlage: 0.76 mm links, 0.75 mm tief
Streuwert: 1.49, horizontal: 1.86, vertikal: 1.00

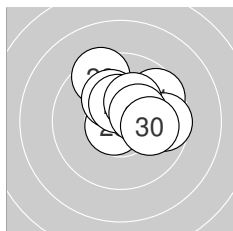

Serie 3: 101.1 (97)

9.7 ↗	9.5 ↖	10.3* ↖	9.6 →	10.7* ↙
10.2* ↖	10.4* ↑	10.3* ↗	10.4* ↗	10.0 →

beste Teiler: 61.6 (25.), 136.6 (27.), 148.1 (29.)
Trefferlage: 0.68 mm rechts, 1.11 mm hoch
Streuwert: 1.44, horizontal: 1.65, vertikal: 1.18

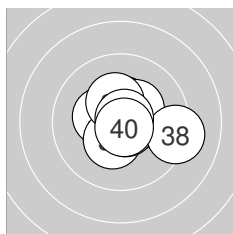

Serie 4: 103.8 (99)

10.3* ←	10.6* →	10.4* ↓	10.4* ↑	10.7* ↘
10.3* ↗	10.3* ↑	9.2 →	10.8* ↗	10.8* ↘

beste Teiler: 39.5 (39.), 48.2 (40.), 58.6 (35.)
Trefferlage: 0.48 mm rechts, 0.13 mm hoch
Streuwert: 1.26, horizontal: 1.51, vertikal: 0.96



Ergebnis: **326** (344.7)
 Serien: 83 80 80 83
 Zähler: 3 12 15 8 2 0 0 0 0 0
 Innenzehner: 2
 Weitester: 3490 (10.), 3207 (29.), 3159 (23.)
 beste Teiler: 405.1 (33.), 428.0 (31.), 561.1 (5.)
 Trefferlage: 3.28 mm links, 3.49 mm hoch
 Streuwert: 13.99, horizontal: 13.47, vertikal: 14.48

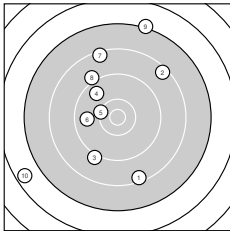
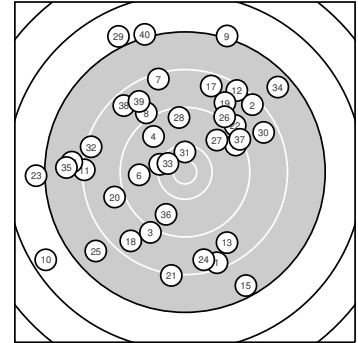

Serie 1: 83 (86.8)

8.4 ↓	8.4 ↗	9.1 ↘	9.7 ↖	10.2 ←
9.7 ←	8.4 ↑	9.1 ↙	7.2 ↑	6.6 ↘

beste Teiler: 561.1 (5.), 972.6 (6.), 1008.9 (4.)
 Trefferlage: 4.24 mm links, 3.35 mm hoch
 Streuwert: 14.45, horizontal: 12.22, vertikal: 16.38

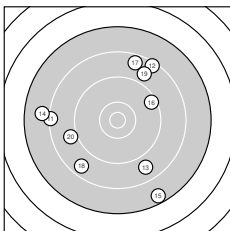

Serie 2: 80 (85.3)

8.3 ←	8.4 ↗	8.8 ↓	7.9 ←	7.5 ↓
9.4 ↗	8.6 ↑	8.6 ↘	8.8 ↗	9.0 ←

beste Teiler: 1220.4 (16.), 1583.6 (20.), 1701.3 (19.)
 Trefferlage: 1.41 mm links, 0.01 mm tief
 Streuwert: 14.69, horizontal: 14.74, vertikal: 14.65

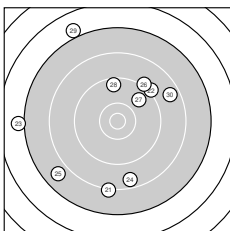

Serie 3: 80 (84.6)

8.2 ↓	9.1 ↗	7.0 ←	8.6 ↓	7.8 ↘
9.1 ↗	9.8 ↗	9.5 ↑	6.9 ↖	8.6 ↘

beste Teiler: 959.5 (27.), 1165.8 (28.), 1446.3 (26.)
 Trefferlage: 2.22 mm links, 1.93 mm hoch
 Streuwert: 15.68, horizontal: 15.06, vertikal: 16.28

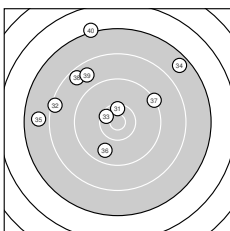

Serie 4: 83 (88.0)

10.4* ↑	8.4 ←	10.4* ↖	7.6 ↗	7.8 ←
9.7 ↓	9.3 ↗	8.6 ↙	8.7 ↖	7.1 ↑

beste Teiler: 405.1 (33.), 428.0 (31.), 981.6 (36.)
 Trefferlage: 5.26 mm links, 8.68 mm hoch
 Streuwert: 12.18, horizontal: 13.51, vertikal: 10.70



Ergebnis: **609.0** (585)
 Serien: 101.6 100.8 102.6 100.5 101.5 102.0
 Zähler: 45 15 0 0 0 0 0 0 0 0
 Innenzehner: 34
 Weitest: 492 (12.), 406 (47.), 383 (17.)
 beste Teiler: 51.4 (29.), 51.9 (51.), 64.8 (15.)
 Trefferlage: 0.53 mm links, 0.28 mm hoch
 Streuwert: 1.52, horizontal: 1.69, vertikal: 1.34

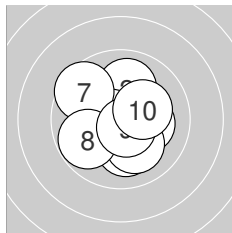
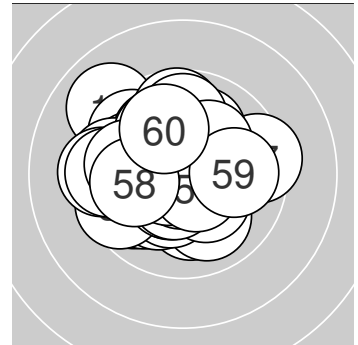

Serie 1: 101.6 (98)

10.3* ↘	10.0 ↑	10.2* →	10.1 ↓	10.1 ↘
10.6* ←	9.6 ↘	9.8 ↙	10.7* ↘	10.2* ↘

beste Teiler: 74.6 (9.), 77.0 (6.), 172.7 (1.)
 Trefferlage: 0.09 mm rechts, 0.25 mm tief
 Streuwert: 1.59, horizontal: 1.61, vertikal: 1.56

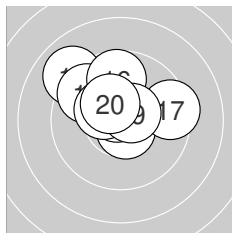

Serie 2: 100.8 (96)

10.6* ↘	9.0 ↘	10.3* ↘	9.7 ↘	10.7* ↘
9.7 ↑	9.4 →	10.4* ↘	10.6* ↗	10.4* ↘

beste Teiler: 64.8 (15.), 78.3 (11.), 96.5 (19.)
 Trefferlage: 0.48 mm links, 1.29 mm hoch
 Streuwert: 1.65, horizontal: 1.98, vertikal: 1.22

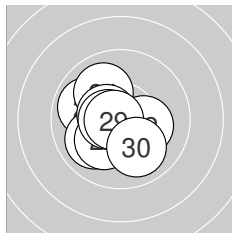

Serie 3: 102.6 (99)

9.9 ↘	10.2* →	10.5* ↘	10.0 ↘	10.0 ↙
10.5* ↘	10.2* ↙	10.6* ←	10.7* ←	10.0 ↘

beste Teiler: 51.4 (29.), 96.0 (28.), 105.8 (23.)
 Trefferlage: 0.75 mm links, 0.20 mm tief
 Streuwert: 1.28, horizontal: 1.31, vertikal: 1.25

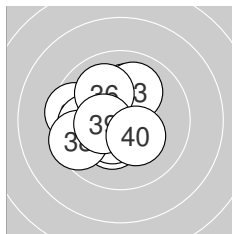

Serie 4: 100.5 (97)

10.3* ↙	10.1 ↑	10.0 ↑	9.5 ←	9.9 ←
10.0 ↘	10.5* ↙	9.5 ←	10.4* ←	10.3* ↘

beste Teiler: 121.4 (37.), 132.0 (39.), 159.0 (31.)
 Trefferlage: 1.04 mm links, 0.09 mm hoch
 Streuwert: 1.56, horizontal: 1.63, vertikal: 1.49

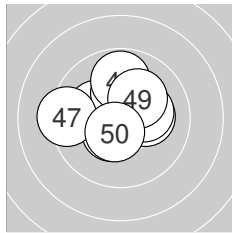

Serie 5: 101.5 (98)

10.4* ↗	10.2* →	10.2* →	10.5* ↙	10.2* ↘
10.2* ↑	9.3 ←	9.8 ↑	10.2* ↗	10.5* ↙

beste Teiler: 113.8 (50.), 123.7 (44.), 136.9 (41.)
 Trefferlage: 0.08 mm links, 0.60 mm hoch
 Streuwert: 1.55, horizontal: 1.83, vertikal: 1.21

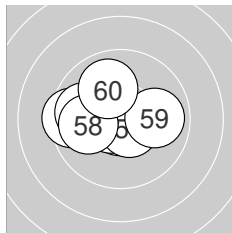

Serie 6: 102.0 (97)

10.7* ↓	10.5* ↘	10.4* ←	9.5 ←	10.6* ↙
9.8 ←	10.6* ↘	10.0 ←	9.9 →	10.0 ↑

beste Teiler: 51.9 (51.), 78.2 (55.), 92.6 (57.)
 Trefferlage: 0.95 mm links, 0.20 mm hoch
 Streuwert: 1.41, horizontal: 1.79, vertikal: 0.86



Ergebnis: **596.6** (570)
 Serien: 100.2 99.5 100.5 100.4 98.1 97.9
 Zähler: 32 26 2 0 0 0 0 0 0 0
 Innenzehner: 25
 Weitester: 586 (22.), 560 (41.), 491 (15.)
 beste Teiler: 22.8 (17.), 49.1 (11.), 53.0 (35.)
 Trefferlage: 0.61 mm rechts, 0.00 mm
 Streuwert: 1.98, horizontal: 2.29, vertikal: 1.60

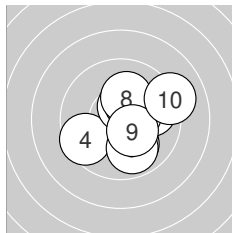
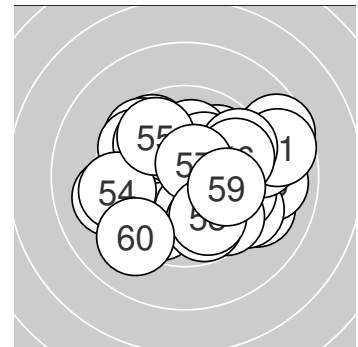

Serie 1: 100.2 (96)

10.0 ↘	9.9 →	10.4* →	9.5 ↖	9.9 ↘
10.5* ↑	10.3* ↗	10.2* ↑	10.4* ↘	9.1 →

beste Teiler: 114.1 (6.), 140.4 (3.), 142.8 (9.)
 Trefferlage: 0.98 mm rechts, 0.00 mm
 Streuwert: 1.77, horizontal: 1.85, vertikal: 1.68

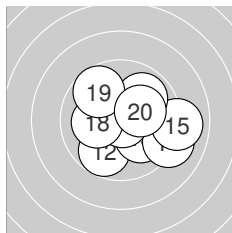

Serie 2: 99.5 (95)

10.8* ↑	9.8 ↙	10.0 ↘	9.1 →	9.0 →
9.9 ↗	10.9* ↘	10.1 ←	9.7 ↖	10.2* ↗

beste Teiler: 22.8 (17.), 49.1 (11.), 188.7 (20.)
 Trefferlage: 0.92 mm rechts, 0.09 mm tief
 Streuwert: 2.04, horizontal: 2.40, vertikal: 1.60

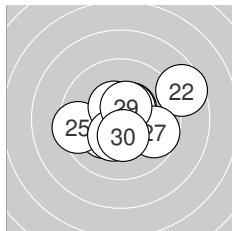

Serie 3: 100.5 (96)

10.4* ↗	8.6 →	10.2* ↖	10.5* ↗	9.4 ←
10.5* ↘	9.7 →	10.3* ↙	10.5* ↑	10.4* ↘

beste Teiler: 115.0 (29.), 120.8 (26.), 121.3 (24.)
 Trefferlage: 0.42 mm rechts, 0.06 mm hoch
 Streuwert: 1.97, horizontal: 2.42, vertikal: 1.39

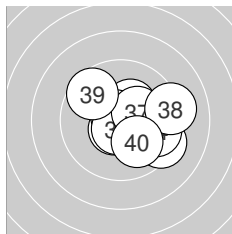

Serie 4: 100.4 (96)

10.6* ↙	9.4 ↘	10.3* ↗	9.7 →	10.7* ↖
10.6* ↙	10.3* ↗	9.2 →	9.6 ↖	10.0 ↘

beste Teiler: 53.0 (35.), 80.4 (36.), 96.6 (31.)
 Trefferlage: 1.09 mm rechts, 0.06 mm tief
 Streuwert: 1.79, horizontal: 2.11, vertikal: 1.41

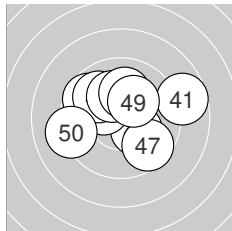

Serie 5: 98.1 (94)

8.7 →	9.7 ↖	10.3* ↘	10.3* ↖	9.9 ↖
10.1 ↖	9.6 ↘	10.1 ↑	10.2* ↗	9.2 ←

beste Teiler: 166.4 (44.), 171.4 (43.), 183.4 (49.)
 Trefferlage: 0.06 mm links, 0.68 mm hoch
 Streuwert: 2.28, horizontal: 2.79, vertikal: 1.61

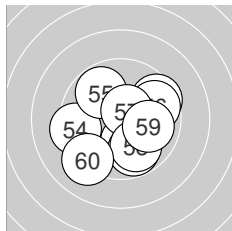

Serie 6: 97.9 (93)

9.5 ↗	10.2* ↘	9.8 ↘	9.3 ←	9.8 ↖
9.7 →	10.6* ↗	9.9 ↘	10.0 →	9.1 ↙

beste Teiler: 91.0 (57.), 198.4 (52.), 249.0 (59.)
 Trefferlage: 0.34 mm rechts, 0.61 mm tief
 Streuwert: 2.22, horizontal: 2.43, vertikal: 2.00



Ergebnis: **625.7** (596)
 Serien: 104.8 105.3 103.8 104.0 103.9 103.9
 Zähler: 56 4 0 0 0 0 0 0 0 0
 Innenzehner: 50
 Weitester: 332 (60.), 313 (21.), 268 (35.)
 beste Teiler: 6.7 (59.), 28.2 (19.), 33.5 (12.)
 Trefferlage: 0.02 mm rechts, 0.08 mm tief
 Streuwert: 1.06, horizontal: 1.11, vertikal: 1.01

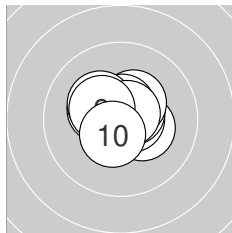
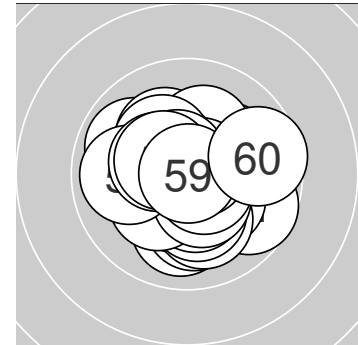

Serie 1: 104.8 (100)

10.3* ↖	10.3* ↘	10.7* →	10.6* ↗	10.4* ↗
10.6* ↑	10.3* ↖	10.7* ↗	10.4* ↖	10.5* ↘

beste Teiler: 59.5 (8.), 75.0 (3.), 82.8 (6.)
 Trefferlage: 0.01 mm links, 0.36 mm hoch
 Streuwert: 0.90, horizontal: 1.06, vertikal: 0.70

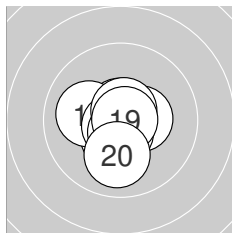

Serie 2: 105.3 (100)

10.7* ↑	10.8* ↑	10.4* →	10.5* ↘	10.1 ↖
10.7* ↗	10.6* ↓	10.7* ↑	10.8* →	10.0 ↓

beste Teiler: 28.2 (19.), 33.5 (12.), 56.5 (16.)
 Trefferlage: 0.14 mm links, 0.24 mm tief
 Streuwert: 0.91, horizontal: 0.87, vertikal: 0.94

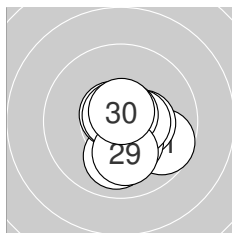

Serie 3: 103.8 (99)

9.7 ↘	10.4* →	10.0 ↓	10.3* ↘	10.7* ↖
10.7* ↖	10.5* →	10.7* ↗	10.1 ↓	10.7* ↑

beste Teiler: 53.8 (28.), 54.4 (26.), 66.2 (30.)
 Trefferlage: 0.55 mm rechts, 0.55 mm tief
 Streuwert: 1.10, horizontal: 1.03, vertikal: 1.16

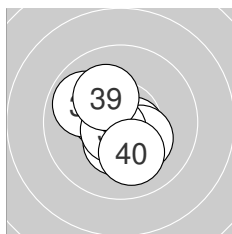

Serie 4: 104.0 (99)

10.5* ↘	10.8* ↖	10.6* ↘	10.5* ↖	9.9 ↖
10.3* ↘	10.4* ↓	10.7* ↗	10.2* ↖	10.1 ↓

beste Teiler: 41.4 (32.), 72.1 (38.), 92.9 (33.)
 Trefferlage: 0.23 mm links, 0.33 mm tief
 Streuwert: 1.15, horizontal: 1.12, vertikal: 1.17

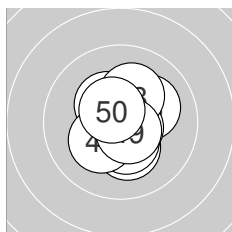

Serie 5: 103.9 (100)

10.4* ↖	10.2* ↓	10.7* ↖	10.4* ↓	10.1 ↗
10.2* ↗	10.6* ↘	10.2* ↑	10.6* ↘	10.5* ↖

beste Teiler: 60.1 (43.), 77.0 (47.), 79.9 (49.)
 Trefferlage: 0.14 mm rechts, 0.00 mm
 Streuwert: 1.08, horizontal: 0.94, vertikal: 1.20

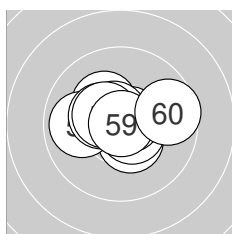

Serie 6: 103.9 (98)

10.3* ↖	10.4* ↘	9.9 ←	10.6* ↘	10.4* ↖
10.7* ↗	10.6* ↖	10.5* ↖	10.9* ↗	9.6 →

beste Teiler: 6.7 (59.), 64.4 (56.), 80.7 (57.)
 Trefferlage: 0.12 mm links, 0.27 mm hoch
 Streuwert: 1.23, horizontal: 1.59, vertikal: 0.70

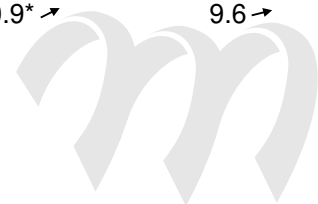

Ergebnis: **554** (577.7)^{OF}
 Serien: 91 93 93 90 91 96
 Zähler: 23 28 9 0 0 0 0 0 0 0
 Innenzehner: 8
 Weitester: 2272 (12.), 2158 (53.), 2060 (25.)
 beste Teiler: 167.5 (52.), 241.2 (56.), 262.0 (57.)
 Trefferlage: 2.06 mm rechts, 0.31 mm hoch
 Streuwert: 8.28, horizontal: 8.72, vertikal: 7.83

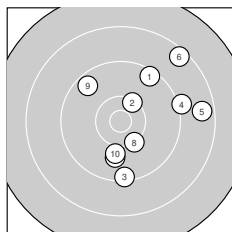
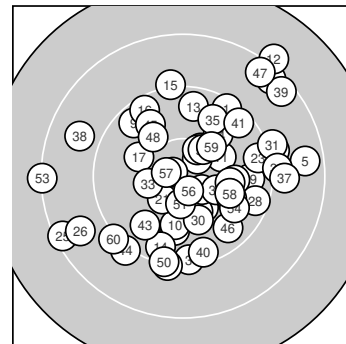

Serie 1: 91 (94.8)

9.4 ↗ 10.3 ↗ 9.3 ↓
 8.4 ↗ 9.9 ↓ 10.2 ↘
 beste Teiler: 508.5 (2.), 575.8 (8.), 753.9 (10.)
 Trefferlage: 4.96 mm rechts, 1.05 mm hoch
 Streuwert: 8.63, horizontal: 8.21, vertikal: 9.04

9.1 → 8.6 →
 9.6 ↘ 10.0 ↓

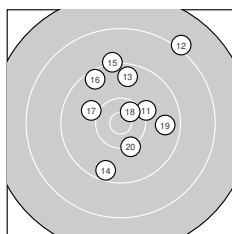

Serie 2: 93 (96.4)

10.1 ↗ 8.1 ↗ 9.6 ↑
 9.5 ↘ 10.0 ↖ 10.5* ↗
 beste Teiler: 341.3 (18.), 588.7 (20.), 656.9 (11.)
 Trefferlage: 1.81 mm rechts, 4.46 mm hoch
 Streuwert: 7.87, horizontal: 6.74, vertikal: 8.87

9.5 ↓ 9.2 ↑
 9.7 → 10.2 ↘

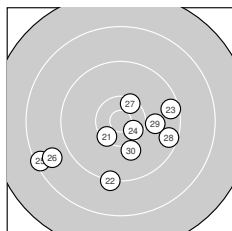

Serie 3: 93 (96.7)

10.4* ↗ 9.2 ↓ 9.5 →
 8.7 ↖ 10.4* ↗ 9.5 →
 beste Teiler: 356.5 (24.), 459.1 (27.), 472.2 (21.)
 Trefferlage: 0.16 mm links, 4.10 mm tief
 Streuwert: 8.22, horizontal: 10.23, vertikal: 5.52

10.5* ↘ 8.4 ↖
 10.0 → 10.1 ↘

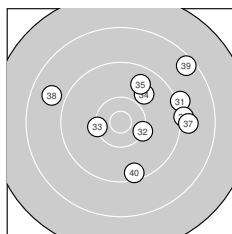

Serie 4: 90 (94.1)

9.1 → 10.3 ↘ 10.3 ←
 9.1 → 9.0 → 8.8 ↖
 beste Teiler: 545.2 (33.), 551.5 (32.), 838.1 (34.)
 Trefferlage: 5.59 mm rechts, 2.51 mm hoch
 Streuwert: 8.65, horizontal: 10.12, vertikal: 6.88

9.9 ↗ 9.7 ↑
 8.5 ↗ 9.4 ↓

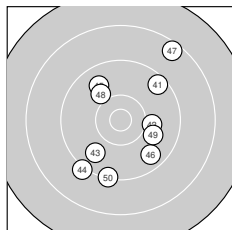

Serie 5: 91 (95.6)

9.5 ↗ 10.0 → 9.8 ↗
 9.6 ↘ 8.5 ↗ 10.0 ↘
 beste Teiler: 728.6 (42.), 754.2 (48.), 821.9 (49.)
 Trefferlage: 1.49 mm rechts, 0.63 mm tief
 Streuwert: 8.70, horizontal: 7.55, vertikal: 9.71

9.2 ↗ 9.8 ↘
 9.9 → 9.3 ↓

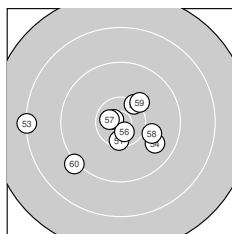

Serie 6: 96 (100.1)

10.4* ↓ 10.7* ↖ 8.3 ←
 10.6* ↓ 10.6* ↖ 10.0 →
 beste Teiler: 167.5 (52.), 241.2 (56.), 262.0 (57.)
 Trefferlage: 1.33 mm links, 1.41 mm tief
 Streuwert: 6.98, horizontal: 8.90, vertikal: 4.27

9.8 ↘ 10.3 ↑
 10.2 ↗ 9.2 ↗



LP 60

StandNr: 101

Gebhart,, Erich #70236285

Männer

Wertung

StartNr: 58

11.01.2025 15:51

SG_Fliess

QF

- Schütze hat sich fürs Finale qualifiziert



Ergebnis: **532** (559.8)
 Serien: 88 87 94 89^{OF} 88 86
 Zähler: 16 25 15 3 1 0 0 0 0 0
 Innenzehner: 8
 Weitester: 3358 (56.), 3158 (21.), 2724 (31.)
 beste Teiler: 113.8 (28.), 189.4 (10.), 258.5 (27.)
 Trefferlage: 2.54 mm rechts, 0.60 mm tief
 Streuwert: 10.42, horizontal: 9.72, vertikal: 11.08

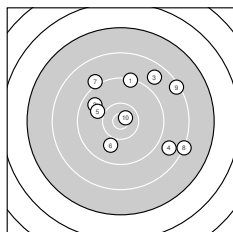
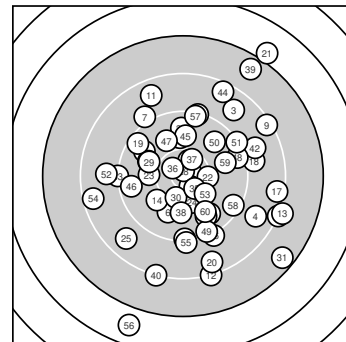

Serie 1: 88 (92.7)

9.3 ↑ 9.7 ↖ 8.7 ↗ 8.8 → 10.0 ↖
 9.9 ↓ 9.1 ↖ 8.2 → 8.3 ↗ 10.7* ↗

beste Teiler: 189.4 (10.), 797.6 (5.), 826.6 (6.)
 Trefferlage: 4.20 mm rechts, 3.54 mm hoch
 Streuwert: 10.18, horizontal: 11.10, vertikal: 9.18

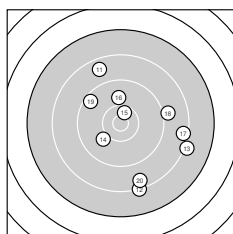

Serie 2: 87 (90.9)

8.7 ↖ 8.2 ↓ 8.1 → 10.0 ↖ 10.5* ↑
 9.9 ↑ 8.4 → 9.0 → 9.5 ↖ 8.6 ↓

beste Teiler: 355.5 (15.), 749.5 (14.), 817.2 (16.)
 Trefferlage: 4.70 mm rechts, 1.66 mm tief
 Streuwert: 11.46, horizontal: 11.01, vertikal: 11.88

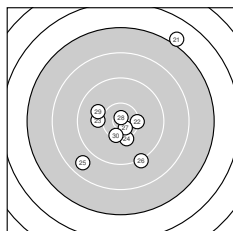

Serie 3: 94 (97.3)

7.0 ↗ 10.3 → 10.1 ← 10.2 ↓ 8.7 ↖
 9.2 ↓ 10.6* ↖ 10.8* ↑ 10.0 ↖ 10.4* ↓

beste Teiler: 113.8 (28.), 258.5 (27.), 475.6 (30.)
 Trefferlage: 0.53 mm rechts, 0.76 mm tief
 Streuwert: 9.76, horizontal: 8.45, vertikal: 10.92

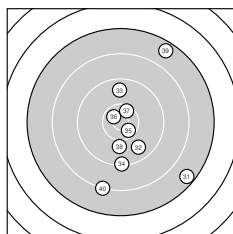

Serie 4: 89 (93.5)

7.5 ↖ 9.7 ↖ 9.7 ↑ 9.3 ↓ 10.5* ↖
 10.6* ↖ 10.4* ↑ 10.0 ↓ 7.6 ↗ 8.2 ↓

beste Teiler: 278.6 (36.), 359.3 (35.), 404.4 (37.)
 Trefferlage: 3.71 mm rechts, 3.17 mm tief
 Streuwert: 10.99, horizontal: 8.11, vertikal: 13.25

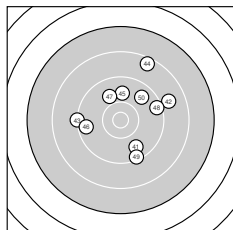

Serie 5: 88 (94.2)

9.7 ↓ 8.9 ↗ 9.2 ← 8.5 ↑ 9.9 ↑
 9.6 ← 9.9 ↖ 9.4 → 9.4 ↓ 9.7 ↗

beste Teiler: 828.5 (47.), 858.7 (45.), 981.4 (41.)
 Trefferlage: 2.42 mm rechts, 2.88 mm hoch
 Streuwert: 9.08, horizontal: 9.41, vertikal: 8.73

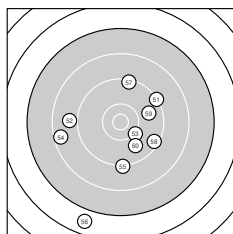

Serie 6: 86 (91.2)

9.3 ↗ 8.9 ← 10.2 ↖ 8.5 ← 9.2 ↓
 6.8 ↓ 9.3 ↑ 9.4 ↖ 9.8 → 9.8 ↖

beste Teiler: 599.8 (53.), 887.5 (60.), 942.4 (59.)
 Trefferlage: 0.29 mm links, 4.45 mm tief
 Streuwert: 11.74, horizontal: 11.22, vertikal: 12.25



LP 60

StandNr: 102

Schatz,, Hubert #70236274

Männer

Wertung

StartNr: 59

11.01.2025 15:28

SG_Fliess

QF

- Schütze hat sich fürs Finale qualifiziert



Ergebnis: **550** (578.0)
Serien: 91 93 93 87^{OF} 94 92
Zähler: 21 31 7 0 0 1 0 0 0 0 0
Innenzehner: 9
Weiteste: 4537 (40.), 2225 (38.), 1947 (3.)
beste Teiler: 69.6 (47.), 99.0 (22.), 140.4 (52.)
Trefferlage: 2.09 mm rechts, 1.12 mm tief
Streuwert: 8.69, horizontal: 7.91, vertikal: 9.42

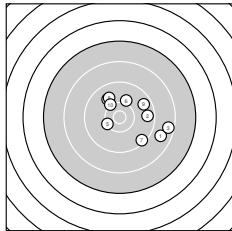
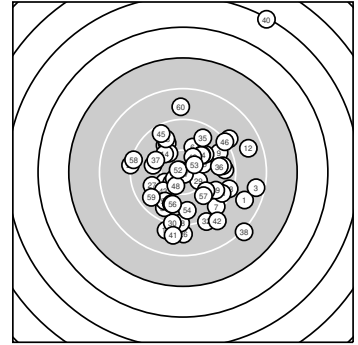

Serie 1: 91 (96.2)

8.7 ↘ 9.6 → 8.5 → 9.9 ↖ 10.3 ↙
 10.1 ↑ 9.4 ↘ 9.9 ↖ 9.6 → 10.2 ↖
beste Teiler: 543.7 (5.), 613.0 (10.), 702.6 (6.)
Trefferlage: 4.94 mm rechts, 0.87 mm hoch
Streuwert: 7.77, horizontal: 9.07, vertikal: 6.21

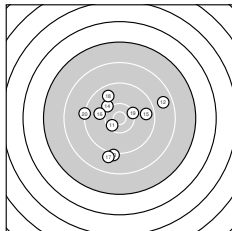

Serie 2: 93 (96.1)

10.4* ↙ 8.7 → 9.1 ↓ 10.1 ↖ 9.6 →
 10.0 ← 9.0 ↓ 9.7 ↖ 10.3 → 9.2 ←
beste Teiler: 403.2 (11.), 557.6 (19.), 670.3 (14.)
Trefferlage: 0.77 mm links, 0.53 mm tief
Streuwert: 8.60, horizontal: 9.08, vertikal: 8.10

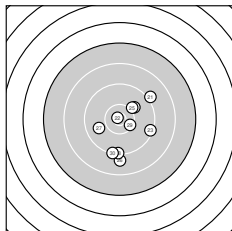

Serie 3: 93 (97.2)

9.1 ↗ 10.8* ↘ 9.4 → 10.0 ↗ 10.1 ↗
 8.9 ↓ 9.9 ↙ 9.3 ↓ 10.4* → 9.3 ↓
beste Teiler: 99.0 (22.), 464.5 (29.), 665.2 (25.)
Trefferlage: 2.67 mm rechts, 3.42 mm tief
Streuwert: 7.50, horizontal: 6.38, vertikal: 8.48

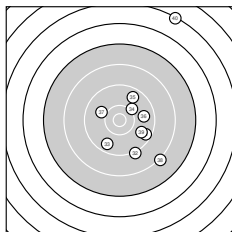

Serie 4: 87 (91.1)

9.5 ↘ 9.2 ↘ 9.6 ↙ 10.1 ↗ 9.7 ↗
 9.8 → 10.0 ← 8.2 ↘ 9.7 → 5.3 ↑
beste Teiler: 650.5 (34.), 773.6 (37.), 959.6 (36.)
Trefferlage: 7.00 mm rechts, 0.98 mm hoch
Streuwert: 12.69, horizontal: 8.59, vertikal: 15.75

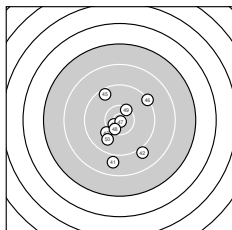

Serie 5: 94 (99.0)

8.9 ↓ 9.0 ↘ 10.1 ↙ 10.6* ↙ 9.5 ↖
 9.3 ↗ 10.9* ↘ 10.5* ↙ 10.4* ↗ 9.8 ↙
beste Teiler: 69.6 (47.), 282.8 (44.), 396.7 (48.)
Trefferlage: 0.06 mm rechts, 2.53 mm tief
Streuwert: 7.25, horizontal: 5.80, vertikal: 8.45

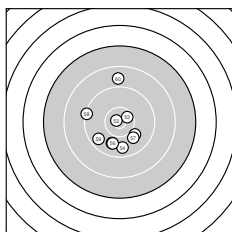

Serie 6: 92 (98.4)

9.9 ↙ 10.8* ↘ 10.5* ↗ 9.7 ↓ 10.0 ↘
 9.9 ↓ 9.9 ↘ 9.3 ← 9.6 ↙ 8.8 ↑
beste Teiler: 140.4 (52.), 353.6 (53.), 770.7 (55.)
Trefferlage: 1.32 mm links, 2.13 mm tief
Streuwert: 7.10, horizontal: 5.86, vertikal: 8.16



LP 60

StandNr: 105

Kecht,, Nicolas #499

Männer

Wertung

StartNr: 62

11.01.2025 15:57

SG_Wörgl

QF

- Schütze hat sich fürs Finale qualifiziert



Ergebnis: **552** (580.3)
 Serien: 92 90 90 93^{OF} 93 94
 Zähler: 20 33 6 1 0 0 0 0 0 0
 Innenzehner: 8
 Weitester: 2496 (23.), 2351 (11.), 2116 (22.)
 beste Teiler: 188.2 (53.), 252.1 (42.), 265.9 (27.)
 Trefferlage: 1.30 mm rechts, 0.82 mm tief
 Streuwert: 7.98, horizontal: 7.94, vertikal: 8.02

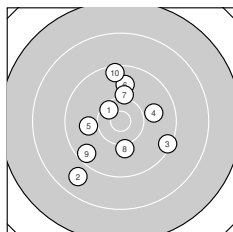
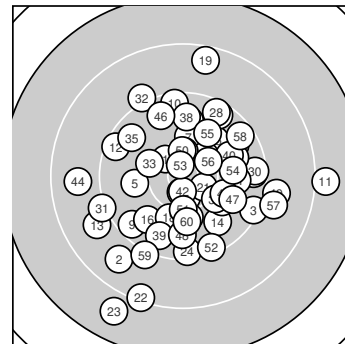

Serie 1: 92 (97.2)

10.4* ↘ 8.8 ↙ 9.3 ↘ 9.9 → 9.9 ←
 9.8 ↑ 10.1 ↑ 10.1 ↓ 9.5 ↙ 9.4 ↑

beste Teiler: 402.3 (1.), 658.1 (7.), 685.0 (8.)
 Trefferlage: 0.82 mm links, 0.26 mm tief
 Streuwert: 7.68, horizontal: 7.09, vertikal: 8.22

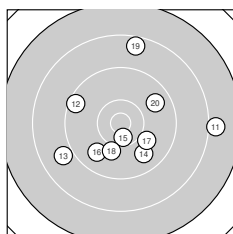

Serie 2: 90 (94.7)

8.0 → 9.4 ↘ 8.9 ↙ 9.8 ↘ 10.5* ↓
 9.8 ↙ 10.0 ↘ 10.1 ↓ 8.5 ↑ 9.7 ↗

beste Teiler: 354.2 (15.), 720.3 (18.), 771.0 (17.)
 Trefferlage: 1.52 mm rechts, 0.91 mm tief
 Streuwert: 9.73, horizontal: 10.82, vertikal: 8.52

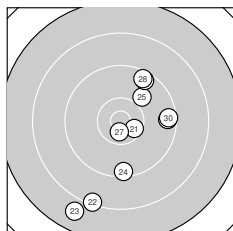

Serie 3: 90 (94.6)

10.5* ↘ 8.3 ↓ 7.8 ↓ 9.4 ↓ 10.0 ↗
 9.5 ↗ 10.6* ↓ 9.5 ↗ 9.5 → 9.5 →

beste Teiler: 265.9 (27.), 382.0 (21.), 795.4 (25.)
 Trefferlage: 2.56 mm rechts, 3.13 mm tief
 Streuwert: 9.72, horizontal: 7.39, vertikal: 11.58

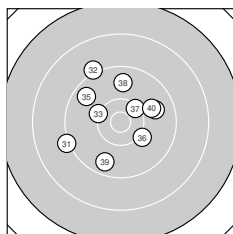

Serie 4: 93 (97.5)

9.2 ← 9.1 ↘ 10.2 ↘ 9.8 → 9.6 ↘
 10.1 ↘ 10.3 ↗ 9.7 ↑ 9.6 ↓ 9.9 ↗

beste Teiler: 495.3 (37.), 589.0 (33.), 652.5 (36.)
 Trefferlage: 1.21 mm links, 2.20 mm hoch
 Streuwert: 7.17, horizontal: 7.44, vertikal: 6.88

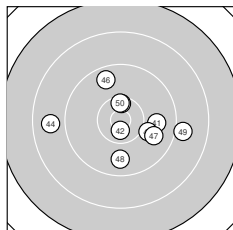

Serie 5: 93 (98.1)

9.8 → 10.6* ↓ 10.4* ↑ 8.8 ← 10.0 ↘
 9.6 ↘ 9.8 ↘ 9.7 ↓ 9.0 → 10.4* ↑

beste Teiler: 252.1 (42.), 408.5 (43.), 421.2 (50.)
 Trefferlage: 1.82 mm rechts, 0.49 mm tief
 Streuwert: 7.34, horizontal: 8.87, vertikal: 5.40

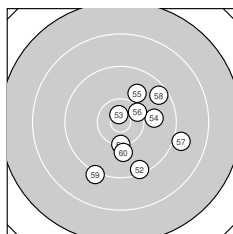

Serie 6: 94 (98.2)

10.3 ↓ 9.4 ↓ 10.7* ↑ 9.9 → 9.9 ↗
 10.3 ↗ 9.0 ↘ 9.5 ↗ 9.2 ↓ 10.0 ↓

beste Teiler: 188.2 (53.), 482.2 (56.), 551.0 (51.)
 Trefferlage: 3.95 mm rechts, 2.34 mm tief
 Streuwert: 6.60, horizontal: 5.96, vertikal: 7.18



LP 60

StandNr: 101

Fuchs,, Andreas #344

Männer

Wertung

StartNr: 112

11.01.2025 17:58

SG_Bruckhäusl

QF

- Schütze hat sich fürs Finale qualifiziert



Ergebnis: **543** (569.2)
 Serien: 92 93 89 92^{OF} 89 88
 Zähler: 21 26 9 3 1 0 0 0 0 0
 Innenzehner: 8
 Weitester: 3408 (29.), 3183 (46.), 3055 (9.)
 beste Teiler: 123.4 (4.), 231.4 (2.), 251.9 (52.)
 Trefferlage: 1.78 mm links, 0.04 mm hoch
 Streuwert: 9.72, horizontal: 8.72, vertikal: 10.62

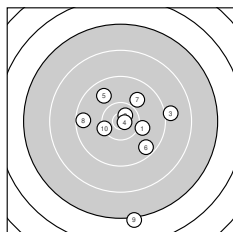
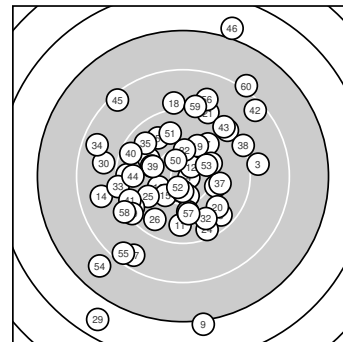

Serie 1: 92 (96.8)

10.1 → 10.7* ↗ 9.0 → 10.8* → 9.8 ↘
 9.6 ↘ 9.9 ↗ 9.5 ← 7.1 ↓ 10.3 ↙

beste Teiler: 123.4 (4.), 231.4 (2.), 544.0 (10.)
 Trefferlage: 2.01 mm rechts, 2.37 mm tief
 Streuwert: 9.35, horizontal: 7.67, vertikal: 10.78

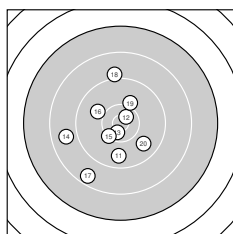

Serie 2: 93 (97.6)

9.7 ↓ 10.6* ↗ 10.6* ↓ 8.8 ← 10.3 ↗
 10.0 ↖ 8.6 ↘ 9.1 ↑ 10.1 ↗ 9.8 ↘

beste Teiler: 256.6 (12.), 297.6 (13.), 535.0 (15.)
 Trefferlage: 2.91 mm links, 1.65 mm tief
 Streuwert: 7.87, horizontal: 6.85, vertikal: 8.77

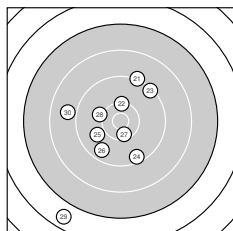

Serie 3: 89 (93.9)

9.2 ↑ 10.3 ↑ 9.3 ↗ 9.5 ↓ 9.9 ↙
 9.6 ↘ 10.4* ↓ 10.1 ↖ 6.7 ↘ 8.9 ↖

beste Teiler: 414.7 (27.), 534.8 (22.), 672.9 (28.)
 Trefferlage: 3.24 mm links, 2.46 mm tief
 Streuwert: 10.66, horizontal: 8.95, vertikal: 12.13

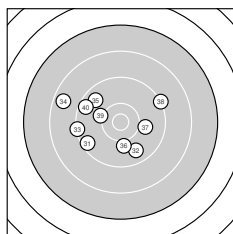

Serie 4: 92 (95.6)

9.5 ↙ 9.7 ↓ 9.3 ← 8.6 ↖ 9.7 ↘
 10.0 ↓ 10.0 → 9.2 ↗ 10.1 ↖ 9.5 ↖

beste Teiler: 646.0 (39.), 733.5 (36.), 772.3 (37.)
 Trefferlage: 3.98 mm links, 0.00 mm
 Streuwert: 8.16, horizontal: 9.83, vertikal: 6.03

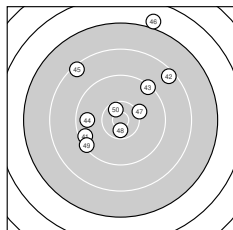

Serie 5: 89 (93.0)

9.5 ↙ 8.5 ↗ 9.3 ↗ 9.7 ← 8.4 ↘
 7.0 ↑ 10.2 ↗ 10.6* ↓ 9.3 ↙ 10.5* ↘

beste Teiler: 312.0 (48.), 354.3 (50.), 633.2 (47.)
 Trefferlage: 0.74 mm links, 5.94 mm hoch
 Streuwert: 10.86, horizontal: 10.16, vertikal: 11.52

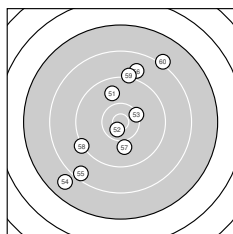

Serie 6: 88 (92.3)

9.8 ↑ 10.6* ↓ 10.3 → 7.8 ↙ 8.5 ↘
 8.9 ↑ 10.0 ↓ 9.2 ↙ 9.1 ↑ 8.1 ↗

beste Teiler: 251.9 (52.), 532.8 (53.), 775.8 (57.)
 Trefferlage: 1.84 mm links, 0.81 mm hoch
 Streuwert: 11.42, horizontal: 9.30, vertikal: 13.20



LP 60

StandNr: 102

Prem,, Florian #347

Männer

Wertung

StartNr: 113

11.01.2025 18:05

SG_Bruckhäusl

QF

– Schütze hat sich fürs Finale qualifiziert



Ergebnis: **542** (569.6)
 Serien: 86 95 94 90^{OF} 87 90
 Zähler: 23 19 16 1 1 0 0 0 0 0
 Innenzehner: 11
 Weitester: 3422 (6.), 2697 (60.), 2169 (12.)
 beste Teiler: 74.3 (17.), 190.0 (34.), 211.6 (14.)
 Trefferlage: 2.92 mm rechts, 4.06 mm tief
 Streuwert: 8.96, horizontal: 10.78, vertikal: 6.66

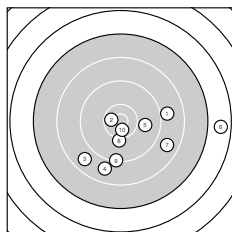
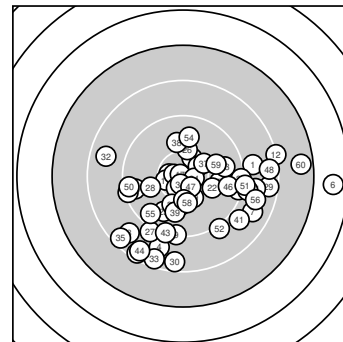

Serie 1: 86 (92.2)

8.9 → 10.5* ← 8.7 ↙ 8.8 ↓ 9.9 →
 6.7 → 8.7 ↘ 10.1 ↓ 9.3 ↓ 10.6* ↓

beste Teiler: 296.5 (10.), 322.2 (2.), 656.9 (8.)
 Trefferlage: 5.19 mm rechts, 6.00 mm tief
 Streuwert: 10.64, horizontal: 13.59, vertikal: 6.45

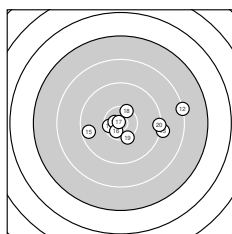

Serie 2: 95 (99.4)

10.4* ← 8.2 → 9.1 → 10.7* ← 9.5 ←
 10.6* ↙ 10.9* ↘ 10.4* ↗ 10.3 ↘ 9.3 →

beste Teiler: 74.3 (17.), 211.6 (14.), 307.9 (16.)
 Trefferlage: 3.42 mm rechts, 0.46 mm tief
 Streuwert: 7.26, horizontal: 9.79, vertikal: 3.10

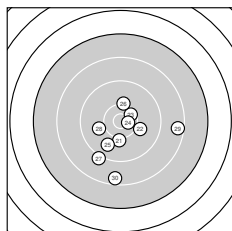

Serie 3: 94 (97.3)

10.1 ↓ 10.1 ↘ 10.4* ↗ 10.6* → 9.8 ↙
 10.2 ↑ 9.1 ↙ 10.0 ← 8.5 → 8.5 ↓

beste Teiler: 259.2 (24.), 414.1 (23.), 608.9 (26.)
 Trefferlage: 1.16 mm rechts, 4.64 mm tief
 Streuwert: 7.66, horizontal: 7.92, vertikal: 7.38

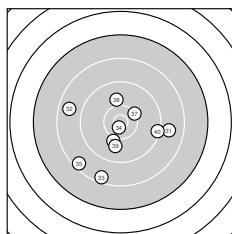

Serie 4: 90 (94.9)

8.9 → 8.7 ← 8.5 ↓ 10.7* ↓ 8.5 ↙
 10.1 ↙ 10.3 ↗ 10.0 ↑ 9.9 ↓ 9.3 →

beste Teiler: 190.0 (34.), 556.7 (37.), 684.8 (36.)
 Trefferlage: 1.06 mm links, 4.00 mm tief
 Streuwert: 9.46, horizontal: 10.56, vertikal: 8.21

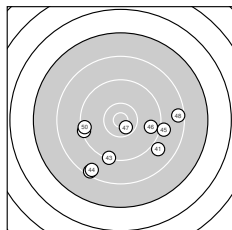

Serie 5: 87 (91.6)

8.9 ↘ 8.4 ↙ 9.3 ↓ 8.5 ↙ 9.1 →
 9.6 → 10.6* ↘ 8.5 → 9.3 ← 9.4 ←

beste Teiler: 302.0 (47.), 1057.1 (46.), 1249.4 (50.)
 Trefferlage: 1.03 mm rechts, 6.97 mm tief
 Streuwert: 10.02, horizontal: 12.44, vertikal: 6.79

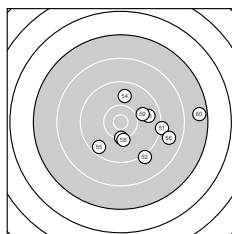

Serie 6: 90 (94.2)

9.2 → 9.1 ↘ 9.7 → 9.8 ↑ 9.5 ↙
 8.8 → 10.3 ↓ 10.2 ↓ 10.0 → 7.6 →

beste Teiler: 537.2 (57.), 613.7 (58.), 800.2 (59.)
 Trefferlage: 7.79 mm rechts, 2.28 mm tief
 Streuwert: 8.22, horizontal: 9.76, vertikal: 6.31

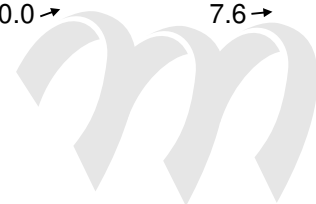

LP 60

StandNr: 103

Engensteiner,, René #70817633

Männer

Wertung

StartNr: 114

11.01.2025 18:02

SG_Tarrenz

QF

- Schütze hat sich fürs Finale qualifiziert



Ergebnis: **367** (384.2)
 Serien: 88 96 93 90
 Zähler: 15 19 5 0 1 0 0 0 0 0 0
 Innenzehner: 6
 Weitester: 3446 (1.), 1910 (8.), 1876 (35.)
 beste Teiler: 258.6 (37.), 353.4 (21.), 363.6 (31.)
 Trefferlage: 1.38 mm links, 2.20 mm tief
 Streuwert: 8.63, horizontal: 9.40, vertikal: 7.79

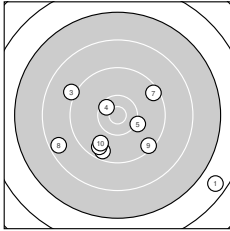
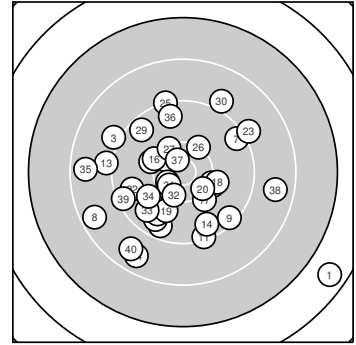

Serie 1: 88 (92.7)

6.6 ↘	9.5 ↓	9.1 ↖	10.5* ↖	10.2 ↘
9.6 ↓	9.4 ↗	8.6 ↙	9.4 ↘	9.8 ↓

beste Teiler: 394.8 (4.), 634.6 (5.), 943.4 (10.)
 Trefferlage: 0.52 mm rechts, 5.17 mm tief
 Streuwert: 11.04, horizontal: 13.19, vertikal: 8.35

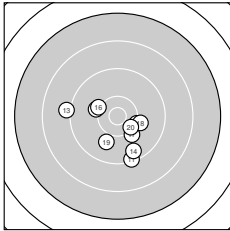

Serie 2: 96 (98.9)

9.3 ↓	10.2 ↘	9.1 ←	9.6 ↓	10.1 ↖
10.2 ↖	10.1 ↘	10.1 →	9.9 ↓	10.3 ↘

beste Teiler: 494.8 (20.), 587.3 (12.), 611.5 (16.)
 Trefferlage: 0.11 mm links, 3.60 mm tief
 Streuwert: 6.15, horizontal: 6.99, vertikal: 5.18

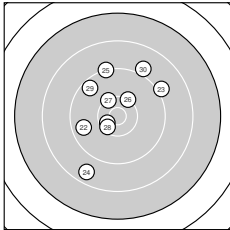

Serie 3: 93 (96.5)

10.5* ↙	9.7 ↙	9.1 ↗	8.6 ↓	9.2 ↑
10.2 ↗	10.3 ↘	10.4* ↙	9.5 ↘	9.0 ↗

beste Teiler: 353.4 (21.), 425.1 (28.), 528.4 (27.)
 Trefferlage: 1.56 mm links, 2.79 mm hoch
 Streuwert: 8.22, horizontal: 7.27, vertikal: 9.07

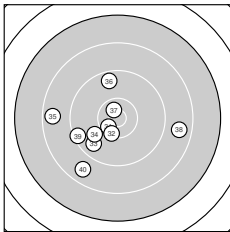

Serie 4: 90 (96.1)

10.5* ↙	10.4* ↓	9.7 ↙	9.9 ↙	8.6 ←
9.6 ↑	10.6* ↖	8.7 →	9.4 ↙	8.7 ↓

beste Teiler: 258.6 (37.), 363.6 (31.), 475.0 (32.)
 Trefferlage: 4.39 mm links, 2.84 mm tief
 Streuwert: 8.21, horizontal: 9.53, vertikal: 6.64



Ergebnis: **358** (373.9)
 Serien: 90 89 91 88
 Zähler: 11 18 9 2 0 0 0 0 0 0
 Innenzehner: 3
 Weitesten: 2960 (35.), 2770 (10.), 2255 (2.)
 beste Teiler: 338.8 (8.), 356.8 (20.), 404.8 (24.)
 Trefferlage: 2.86 mm rechts, 0.33 mm tief
 Streuwert: 10.00, horizontal: 10.09, vertikal: 9.91

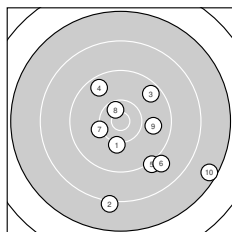
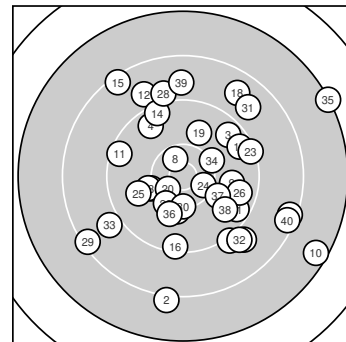

Serie 1: 90 (93.6)

10.1 ↓ 8.1 ↓ 9.6 ↗
 9.0 ↘ 10.2 ↖ 10.5* ↖
 beste Teiler: 338.8 (8.), 611.3 (7.), 645.2 (1.)
 Trefferlage: 4.35 mm rechts, 4.94 mm tief
 Streuwert: 9.75, horizontal: 9.44, vertikal: 10.04

9.6 ↖ 9.2 ↘
 9.8 → 7.5 ↘

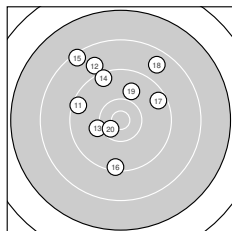

Serie 2: 89 (94.2)

9.4 ↖ 8.9 ↖ 10.1 ↖
 9.4 ↓ 9.5 ↗ 8.7 ↗
 beste Teiler: 356.8 (20.), 664.7 (13.), 833.4 (19.)
 Trefferlage: 2.23 mm links, 5.81 mm hoch
 Streuwert: 8.65, horizontal: 7.81, vertikal: 9.42

9.4 ↖ 8.4 ↖
 9.9 ↑ 10.5* ↗

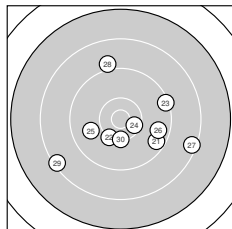

Serie 3: 91 (94.9)

9.5 ↘ 10.2 ↗ 9.3 →
 9.6 → 8.4 → 9.0 ↑
 beste Teiler: 404.8 (24.), 546.0 (30.), 579.6 (22.)
 Trefferlage: 2.33 mm rechts, 2.34 mm tief
 Streuwert: 9.27, horizontal: 10.86, vertikal: 7.35

10.4* → 9.9 ↖
 8.3 ↖ 10.3 ↓

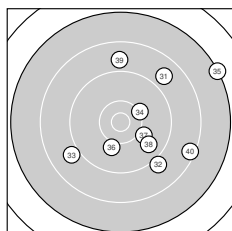

Serie 4: 88 (91.2)

8.8 ↗ 9.0 ↘ 9.0 ↖
 10.0 ↓ 10.0 ↘ 9.7 ↘
 beste Teiler: 594.7 (34.), 722.7 (37.), 723.0 (36.)
 Trefferlage: 7.01 mm rechts, 0.13 mm hoch
 Streuwert: 10.81, horizontal: 11.05, vertikal: 10.58

10.2 ↗ 7.3 ↗
 8.8 ↑ 8.4 ↘



Ergebnis: **328** (346.2)
 Serien: 81 88 81 78
 Zähler: 4 15 10 8 2 1 0 0 0 0 0
 Innenzehner: 2
 Weitester: 4616 (8.), 3796 (3.), 3445 (35.)
 beste Teiler: 253.7 (5.), 306.4 (19.), 664.4 (33.)
 Trefferlage: 1.12 mm rechts, 6.58 mm hoch
 Streuwert: 13.96, horizontal: 14.76, vertikal: 13.12

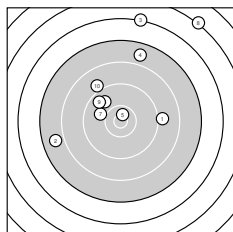
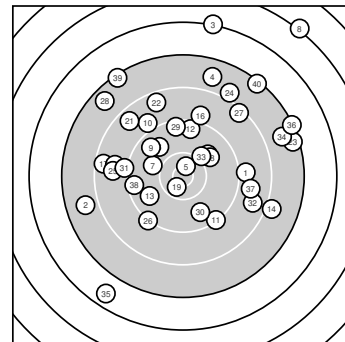

Serie 1: 81 (85.0)
 9.0 → 7.8 ← 6.2 ↑ 7.8 ↑ 10.6* ↑
 9.8 ↘ 10.0 ↖ 5.2 ↗ 9.6 ↘ 9.0 ↘
 beste Teiler: 253.7 (5.), 786.6 (7.), 921.5 (6.)
 Trefferlage: 0.57 mm rechts, 12.39 mm hoch
 Streuwert: 15.00, horizontal: 14.75, vertikal: 15.24

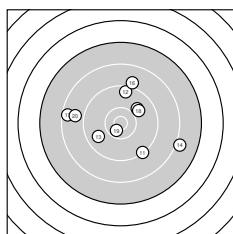

Serie 2: 88 (93.3)
 9.3 ↘ 9.5 ↑ 9.8 ← 8.0 → 9.9 ↗
 9.0 ↑ 8.5 ← 9.9 ↗ 10.6* ↘ 8.8 ←
 beste Teiler: 306.4 (19.), 809.4 (18.), 811.4 (15.)
 Trefferlage: 0.28 mm rechts, 1.58 mm hoch
 Streuwert: 10.48, horizontal: 12.34, vertikal: 8.22

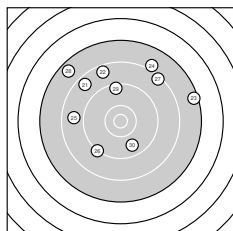

Serie 3: 81 (85.6)
 8.6 ↘ 8.5 ↖ 7.4 → 8.0 ↑ 8.8 ←
 9.2 ↗ 8.4 ↗ 7.6 ↘ 9.4 ↑ 9.7 ↘
 beste Teiler: 980.3 (30.), 1223.4 (29.), 1385.1 (26.)
 Trefferlage: 0.98 mm links, 8.81 mm hoch
 Streuwert: 13.25, horizontal: 14.95, vertikal: 11.30

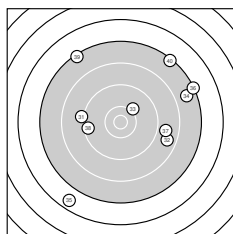

Serie 4: 78 (82.3)
 9.1 ← 8.7 → 10.1 ↗ 7.7 → 6.6 ↘
 7.3 ↗ 8.8 → 9.4 ← 7.3 ↘ 7.3 ↗
 beste Teiler: 664.4 (33.), 1214.9 (38.), 1451.1 (31.)
 Trefferlage: 4.61 mm rechts, 3.53 mm hoch
 Streuwert: 16.86, horizontal: 18.19, vertikal: 15.41



Ergebnis: **356** (375.2)
 Serien: 88 89 94 85
 Zähler: 14 14 8 2 2 0 0 0 0 0 0
 Innenzehner: 8
 Weitester: 3831 (40.), 3512 (5.), 2707 (33.)
 beste Teiler: 207.5 (37.), 237.7 (1.), 294.4 (28.)
 Trefferlage: 1.13 mm links, 0.62 mm tief
 Streuwert: 10.92, horizontal: 10.75, vertikal: 11.08

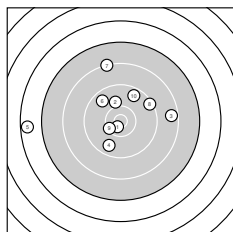
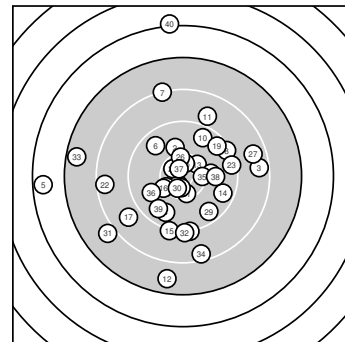

Serie 1: 88 (92.7)

10.7* ↙	10.0 ↑	8.5 →	9.7 ↙	6.6 ←
9.7 ↘	8.2 ↑	9.4 ↗	10.3 ↖	9.6 ↗

beste Teiler: 237.7 (1.), 500.2 (9.), 745.2 (2.)
 Trefferlage: 2.37 mm links, 3.81 mm hoch
 Streuwert: 11.66, horizontal: 14.14, vertikal: 8.47

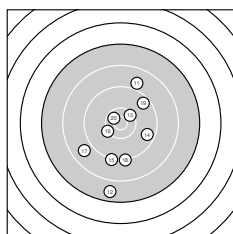

Serie 2: 89 (94.1)

8.9 ↑	7.7 ↓	10.4* ↗	9.6 ↘	9.2 ↓
10.2 ↖	8.8 ↖	9.2 ↓	9.5 ↗	10.6* ↘

beste Teiler: 315.4 (20.), 465.1 (13.), 575.2 (16.)
 Trefferlage: 0.15 mm rechts, 4.33 mm tief
 Streuwert: 9.86, horizontal: 7.24, vertikal: 11.93

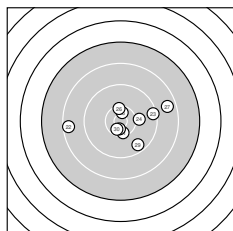

Serie 3: 94 (98.6)

10.4* ↓	8.5 ←	9.4 →	10.1 →	10.5* ↑
10.4 ↑	8.6 →	10.6* ↓	9.6 ↘	10.5* ↓

beste Teiler: 294.4 (28.), 327.3 (25.), 334.2 (30.)
 Trefferlage: 2.27 mm rechts, 0.41 mm tief
 Streuwert: 7.73, horizontal: 9.92, vertikal: 4.59

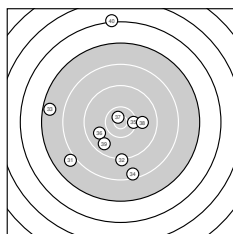

Serie 4: 85 (89.8)

8.0 ↖	9.2 ↓	7.6 ←	8.4 ↓	10.3 →
9.8 ↖	10.7* ↘	9.9 →	9.7 ↙	6.2 ↑

beste Teiler: 207.5 (37.), 485.0 (35.), 819.0 (38.)
 Trefferlage: 4.59 mm links, 1.56 mm tief
 Streuwert: 13.76, horizontal: 10.96, vertikal: 16.09



Ergebnis: **320** (339.8)
 Serien: 75 81 79 85
 Zähler: 5 9 9 15 2 0 0 0 0 0
 Innenezehner: 3
 Weitester: 3737 (6.), 3266 (1.), 3109 (28.)
 beste Teiler: 256.0 (13.), 417.9 (31.), 445.9 (35.)
 Trefferlage: 5.24 mm links, 9.13 mm tief
 Streuwert: 13.46, horizontal: 12.76, vertikal: 14.12

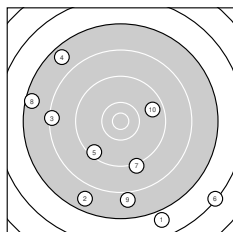
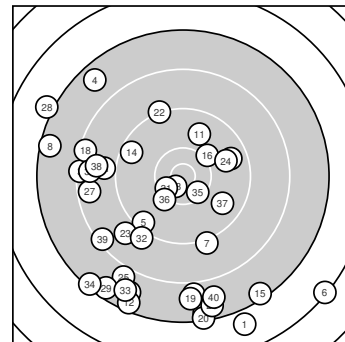

Serie 1: 75 (80.4)

6.9 ↘	7.7 ↘	8.3 ←	7.6 ↖	9.4 ↗
6.3 ↘	9.1 ↘	7.5 ←	7.9 ↓	9.7 ↗

beste Teiler: 1038.6 (10.), 1239.1 (5.), 1445.5 (7.)
 Trefferlage: 2.66 mm links, 9.41 mm tief
 Streuwert: 16.92, horizontal: 17.41, vertikal: 16.43

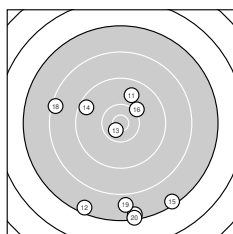

Serie 2: 81 (85.7)

9.8 ↗	7.4 ↘	10.6* ↗	9.5 ↖	7.4 ↘
10.1 ↗	7.4 ↓	8.4 ←	7.8 ↓	7.3 ↓

beste Teiler: 256.0 (13.), 651.1 (16.), 918.8 (11.)
 Trefferlage: 0.87 mm links, 11.05 mm tief
 Streuwert: 13.61, horizontal: 10.23, vertikal: 16.30

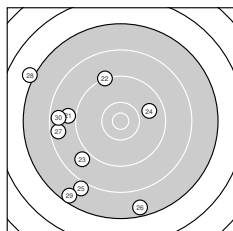

Serie 3: 79 (84.1)

8.9 ←	9.2 ↖	8.9 ↗	9.8 →	8.0 ↘
7.6 ↓	8.5 ←	7.1 ↖	7.5 ↗	8.6 ←

beste Teiler: 930.5 (24.), 1390.1 (22.), 1611.2 (21.)
 Trefferlage: 11.13 mm links, 5.14 mm tief
 Streuwert: 13.05, horizontal: 11.41, vertikal: 14.51

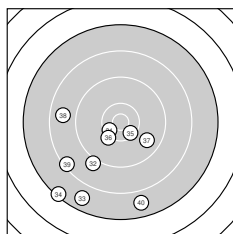

Serie 4: 85 (89.6)

10.4* ↗	9.1 ↘	7.7 ↘	7.3 ↗	10.4* ↘
10.2 ↗	9.7 ↘	8.7 ←	8.3 ↗	7.8 ↓

beste Teiler: 417.9 (31.), 445.9 (35.), 607.3 (36.)
 Trefferlage: 6.29 mm links, 10.90 mm tief
 Streuwert: 9.79, horizontal: 9.95, vertikal: 9.63



Ergebnis: **347** (368.7)
 Serien: 83 90 85 89
 Zähler: 5 21 10 4 0 0 0 0 0 0
 Innenzehner: 2
 Weitester: 2973 (4.), 2669 (8.), 2455 (16.)
 beste Teiler: 330.9 (17.), 448.0 (14.), 624.0 (19.)
 Trefferlage: 8.64 mm rechts, 2.26 mm tief
 Streuwert: 8.68, horizontal: 7.86, vertikal: 9.42

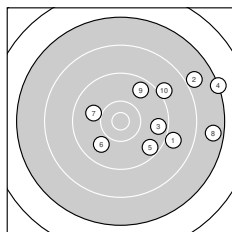
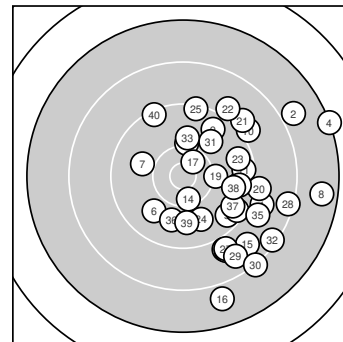

Serie 1: 83 (89.1)

8.9 →	7.9 ↗	9.6 →	7.2 →	9.5 ↘
9.9 ↙	9.9 ←	7.6 →	9.6 ↗	9.0 ↗

beste Teiler: 807.6 (7.), 861.9 (6.), 1061.0 (9.)
 Trefferlage: 11.47 mm rechts, 1.78 mm hoch
 Streuwert: 10.06, horizontal: 12.03, vertikal: 7.60

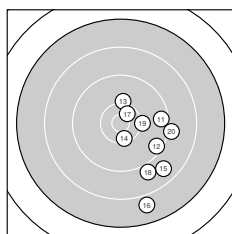

Serie 2: 90 (94.8)

9.5 →	9.4 ↘	10.2 ↑	10.4* ↓	8.7 ↘
7.9 ↓	10.5* ↗	8.9 ↘	10.2 →	9.1 →

beste Teiler: 330.9 (17.), 448.0 (14.), 624.0 (19.)
 Trefferlage: 7.39 mm rechts, 5.34 mm tief
 Streuwert: 7.30, horizontal: 4.92, vertikal: 9.07

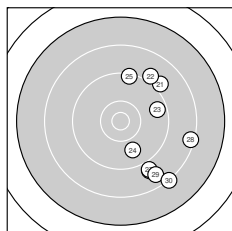

Serie 3: 85 (89.8)

9.0 ↗	9.0 ↗	9.6 →	9.8 ↓	9.3 ↑
8.9 ↘	8.9 ↘	8.4 →	8.7 ↓	8.2 ↘

beste Teiler: 893.6 (24.), 1102.8 (23.), 1307.5 (25.)
 Trefferlage: 9.67 mm rechts, 3.40 mm tief
 Streuwert: 9.34, horizontal: 5.00, vertikal: 12.23

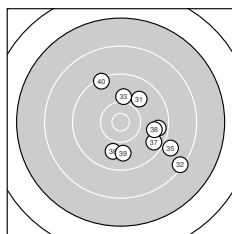

Serie 4: 89 (95.0)

9.9 ↗	8.3 ↘	10.0 ↑	9.6 →	8.9 ↘
9.9 ↓	9.6 ↘	9.7 →	9.8 ↓	9.3 ↗

beste Teiler: 733.9 (33.), 846.3 (31.), 862.7 (36.)
 Trefferlage: 6.04 mm rechts, 2.07 mm tief
 Streuwert: 7.73, horizontal: 7.39, vertikal: 8.04



Ergebnis: **367** (384.2)
 Serien: 88 96 93 90
 Zähler: 15 19 5 0 1 0 0 0 0 0 0
 Innenzehner: 6
 Weitester: 3446 (1.), 1910 (8.), 1876 (35.)
 beste Teiler: 258.6 (37.), 353.4 (21.), 363.6 (31.)
 Trefferlage: 1.38 mm links, 2.20 mm tief
 Streuwert: 8.63, horizontal: 9.40, vertikal: 7.79

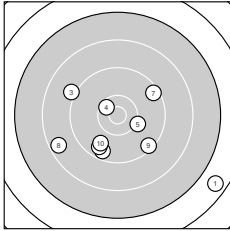
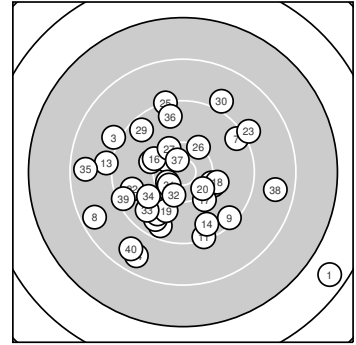

Serie 1: 88 (92.7)

6.6 ↘	9.5 ↓	9.1 ↖	10.5* ↖	10.2 ↘
9.6 ↓	9.4 ↗	8.6 ↙	9.4 ↘	9.8 ↓

beste Teiler: 394.8 (4.), 634.6 (5.), 943.4 (10.)
 Trefferlage: 0.52 mm rechts, 5.17 mm tief
 Streuwert: 11.04, horizontal: 13.19, vertikal: 8.35

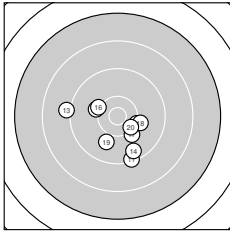

Serie 2: 96 (98.9)

9.3 ↓	10.2 ↘	9.1 ←	9.6 ↓	10.1 ↖
10.2 ↖	10.1 ↘	10.1 →	9.9 ↓	10.3 ↘

beste Teiler: 494.8 (20.), 587.3 (12.), 611.5 (16.)
 Trefferlage: 0.11 mm links, 3.60 mm tief
 Streuwert: 6.15, horizontal: 6.99, vertikal: 5.18

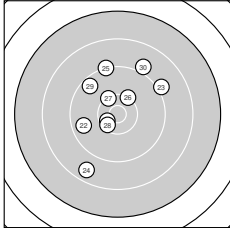

Serie 3: 93 (96.5)

10.5* ↙	9.7 ↙	9.1 ↗	8.6 ↓	9.2 ↑
10.2 ↗	10.3 ↘	10.4* ↙	9.5 ↖	9.0 ↗

beste Teiler: 353.4 (21.), 425.1 (28.), 528.4 (27.)
 Trefferlage: 1.56 mm links, 2.79 mm hoch
 Streuwert: 8.22, horizontal: 7.27, vertikal: 9.07

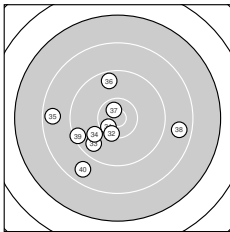

Serie 4: 90 (96.1)

10.5* ↙	10.4* ↓	9.7 ↙	9.9 ↙	8.6 ←
9.6 ↑	10.6* ↖	8.7 →	9.4 ↙	8.7 ↓

beste Teiler: 258.6 (37.), 363.6 (31.), 475.0 (32.)
 Trefferlage: 4.39 mm links, 2.84 mm tief
 Streuwert: 8.21, horizontal: 9.53, vertikal: 6.64



Ergebnis: **358** (373.9)
 Serien: 90 89 91 88
 Zähler: 11 18 9 2 0 0 0 0 0 0
 Innenzehner: 3
 Weitester: 2960 (35.), 2770 (10.), 2255 (2.)
 beste Teiler: 338.8 (8.), 356.8 (20.), 404.8 (24.)
 Trefferlage: 2.86 mm rechts, 0.33 mm tief
 Streuwert: 10.00, horizontal: 10.09, vertikal: 9.91

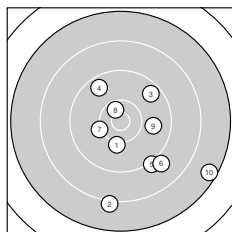
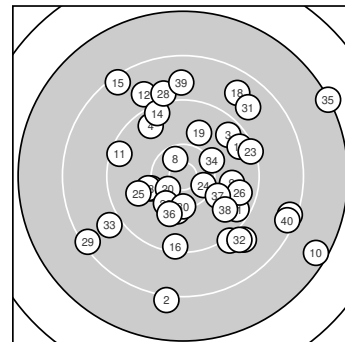

Serie 1: 90 (93.6)

10.1 ↓ 8.1 ↓ 9.6 ↗
 9.0 ↘ 10.2 ↖ 10.5* ↖
 beste Teiler: 338.8 (8.), 611.3 (7.), 645.2 (1.)
 Trefferlage: 4.35 mm rechts, 4.94 mm tief
 Streuwert: 9.75, horizontal: 9.44, vertikal: 10.04

9.6 ↖ 9.2 ↘
 9.8 → 7.5 ↘

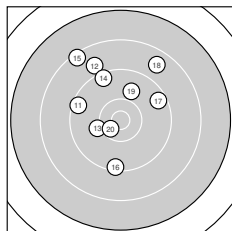

Serie 2: 89 (94.2)

9.4 ↖ 8.9 ↖ 10.1 ↖
 9.4 ↓ 9.5 ↗ 8.7 ↗
 beste Teiler: 356.8 (20.), 664.7 (13.), 833.4 (19.)
 Trefferlage: 2.23 mm links, 5.81 mm hoch
 Streuwert: 8.65, horizontal: 7.81, vertikal: 9.42

9.4 ↖ 8.4 ↖
 9.9 ↑ 10.5* ↗

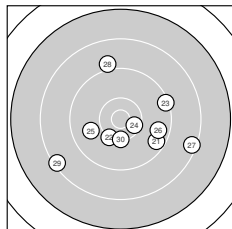

Serie 3: 91 (94.9)

9.5 ↘ 10.2 ↗ 9.3 →
 9.6 → 8.4 ↘ 9.0 ↑
 beste Teiler: 404.8 (24.), 546.0 (30.), 579.6 (22.)
 Trefferlage: 2.33 mm rechts, 2.34 mm tief
 Streuwert: 9.27, horizontal: 10.86, vertikal: 7.35

10.4* → 9.9 ↖
 8.3 ↖ 10.3 ↓

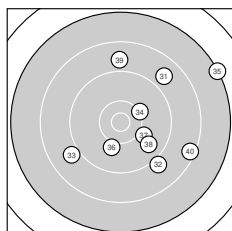

Serie 4: 88 (91.2)

8.8 ↗ 9.0 ↘ 9.0 ↖
 10.0 ↓ 10.0 ↘ 9.7 ↘
 beste Teiler: 594.7 (34.), 722.7 (37.), 723.0 (36.)
 Trefferlage: 7.01 mm rechts, 0.13 mm hoch
 Streuwert: 10.81, horizontal: 11.05, vertikal: 10.58

10.2 ↗ 7.3 ↗
 8.8 ↑ 8.4 ↘



Ergebnis: **328** (346.2)
 Serien: 81 88 81 78
 Zähler: 4 15 10 8 2 1 0 0 0 0 0
 Innenzehner: 2
 Weitesten: 4616 (8.), 3796 (3.), 3445 (35.)
 beste Teiler: 253.7 (5.), 306.4 (19.), 664.4 (33.)
 Trefferlage: 1.12 mm rechts, 6.58 mm hoch
 Streuwert: 13.96, horizontal: 14.76, vertikal: 13.12

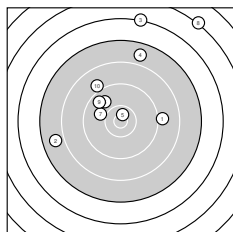
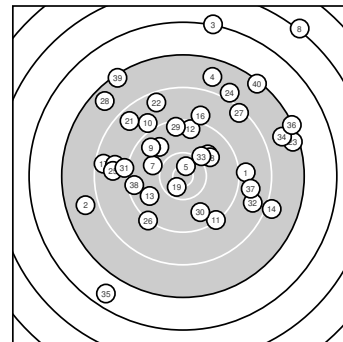

Serie 1: 81 (85.0)
 9.0 → 7.8 ← 6.2 ↑ 7.8 ↑ 10.6* ↑
 9.8 ↘ 10.0 ↖ 5.2 ↗ 9.6 ↘ 9.0 ↘
 beste Teiler: 253.7 (5.), 786.6 (7.), 921.5 (6.)
 Trefferlage: 0.57 mm rechts, 12.39 mm hoch
 Streuwert: 15.00, horizontal: 14.75, vertikal: 15.24

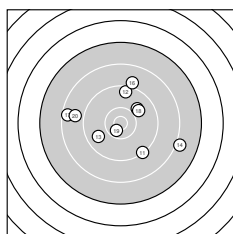

Serie 2: 88 (93.3)
 9.3 ↘ 9.5 ↑ 9.8 ← 8.0 → 9.9 ↗
 9.0 ↑ 8.5 ← 9.9 ↗ 10.6* ↘ 8.8 ←
 beste Teiler: 306.4 (19.), 809.4 (18.), 811.4 (15.)
 Trefferlage: 0.28 mm rechts, 1.58 mm hoch
 Streuwert: 10.48, horizontal: 12.34, vertikal: 8.22

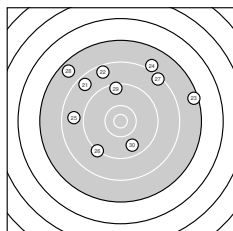

Serie 3: 81 (85.6)
 8.6 ↘ 8.5 ↖ 7.4 → 8.0 ↑ 8.8 ←
 9.2 ↗ 8.4 ↗ 7.6 ↘ 9.4 ↑ 9.7 ↘
 beste Teiler: 980.3 (30.), 1223.4 (29.), 1385.1 (26.)
 Trefferlage: 0.98 mm links, 8.81 mm hoch
 Streuwert: 13.25, horizontal: 14.95, vertikal: 11.30

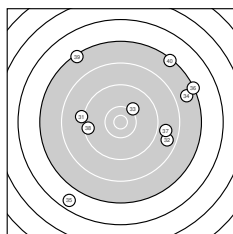

Serie 4: 78 (82.3)
 9.1 ← 8.7 → 10.1 ↗ 7.7 → 6.6 ↘
 7.3 ↗ 8.8 → 9.4 ← 7.3 ↘ 7.3 ↗
 beste Teiler: 664.4 (33.), 1214.9 (38.), 1451.1 (31.)
 Trefferlage: 4.61 mm rechts, 3.53 mm hoch
 Streuwert: 16.86, horizontal: 18.19, vertikal: 15.41



Ergebnis: **356** (375.2)
 Serien: 88 89 94 85
 Zähler: 14 14 8 2 2 0 0 0 0 0 0
 Innenzehner: 8
 Weitester: 3831 (40.), 3512 (5.), 2707 (33.)
 beste Teiler: 207.5 (37.), 237.7 (1.), 294.4 (28.)
 Trefferlage: 1.13 mm links, 0.62 mm tief
 Streuwert: 10.92, horizontal: 10.75, vertikal: 11.08

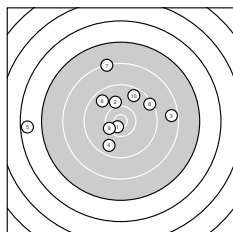
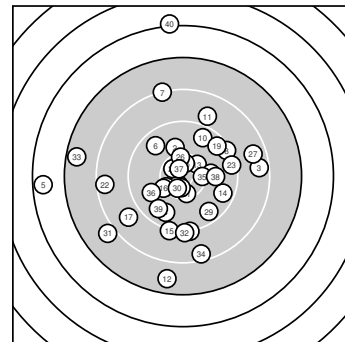

Serie 1: 88 (92.7)

10.7* ↙	10.0 ↑	8.5 →	9.7 ↙	6.6 ←
9.7 ↘	8.2 ↑	9.4 ↗	10.3 ↖	9.6 ↗

beste Teiler: 237.7 (1.), 500.2 (9.), 745.2 (2.)
 Trefferlage: 2.37 mm links, 3.81 mm hoch
 Streuwert: 11.66, horizontal: 14.14, vertikal: 8.47

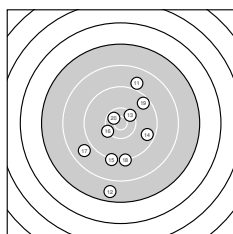

Serie 2: 89 (94.1)

8.9 ↑	7.7 ↓	10.4* ↗	9.6 ↘	9.2 ↓
10.2 ↖	8.8 ↖	9.2 ↓	9.5 ↗	10.6* ↘

beste Teiler: 315.4 (20.), 465.1 (13.), 575.2 (16.)
 Trefferlage: 0.15 mm rechts, 4.33 mm tief
 Streuwert: 9.86, horizontal: 7.24, vertikal: 11.93

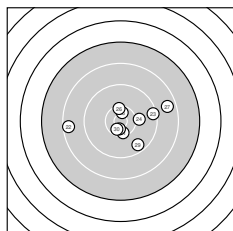

Serie 3: 94 (98.6)

10.4* ↓	8.5 ←	9.4 →	10.1 →	10.5* ↑
10.4 ↑	8.6 →	10.6* ↓	9.6 ↘	10.5* ↓

beste Teiler: 294.4 (28.), 327.3 (25.), 334.2 (30.)
 Trefferlage: 2.27 mm rechts, 0.41 mm tief
 Streuwert: 7.73, horizontal: 9.92, vertikal: 4.59

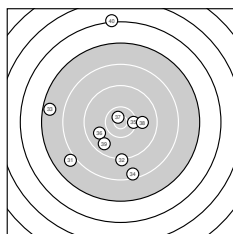

Serie 4: 85 (89.8)

8.0 ↖	9.2 ↓	7.6 ←	8.4 ↓	10.3 →
9.8 ↖	10.7* ↘	9.9 →	9.7 ↙	6.2 ↑

beste Teiler: 207.5 (37.), 485.0 (35.), 819.0 (38.)
 Trefferlage: 4.59 mm links, 1.56 mm tief
 Streuwert: 13.76, horizontal: 10.96, vertikal: 16.09



Ergebnis: **320** (339.8)
 Serien: 75 81 79 85
 Zähler: 5 9 9 15 2 0 0 0 0 0 0
 Innenzehner: 3
 Weitester: 3737 (6.), 3266 (1.), 3109 (28.)
 beste Teiler: 256.0 (13.), 417.9 (31.), 445.9 (35.)
 Trefferlage: 5.24 mm links, 9.13 mm tief
 Streuwert: 13.46, horizontal: 12.76, vertikal: 14.12

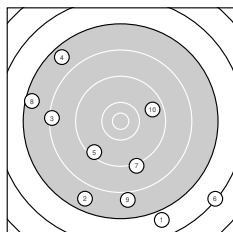
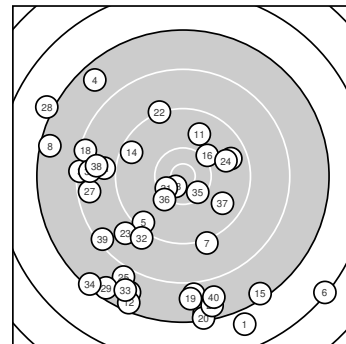

Serie 1: 75 (80.4)

6.9 ↘	7.7 ↘	8.3 ←	7.6 ↖	9.4 ↗
6.3 ↘	9.1 ↘	7.5 ←	7.9 ↓	9.7 ↗

beste Teiler: 1038.6 (10.), 1239.1 (5.), 1445.5 (7.)
 Trefferlage: 2.66 mm links, 9.41 mm tief
 Streuwert: 16.92, horizontal: 17.41, vertikal: 16.43

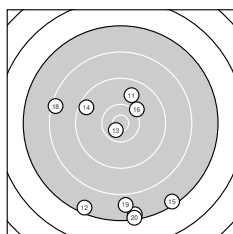

Serie 2: 81 (85.7)

9.8 ↗	7.4 ↘	10.6* ↗	9.5 ↖	7.4 ↘
10.1 ↗	7.4 ↓	8.4 ←	7.8 ↓	7.3 ↓

beste Teiler: 256.0 (13.), 651.1 (16.), 918.8 (11.)
 Trefferlage: 0.87 mm links, 11.05 mm tief
 Streuwert: 13.61, horizontal: 10.23, vertikal: 16.30

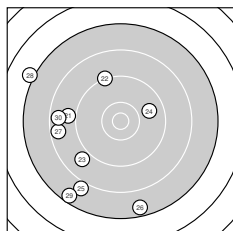

Serie 3: 79 (84.1)

8.9 ←	9.2 ↖	8.9 ↗	9.8 →	8.0 ↘
7.6 ↓	8.5 ←	7.1 ↖	7.5 ↗	8.6 ←

beste Teiler: 930.5 (24.), 1390.1 (22.), 1611.2 (21.)
 Trefferlage: 11.13 mm links, 5.14 mm tief
 Streuwert: 13.05, horizontal: 11.41, vertikal: 14.51

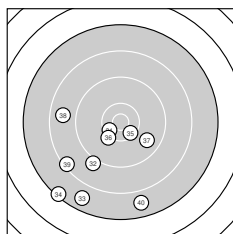

Serie 4: 85 (89.6)

10.4* ↗	9.1 ↘	7.7 ↘	7.3 ↗	10.4* ↘
10.2 ↗	9.7 ↘	8.7 ←	8.3 ↗	7.8 ↓

beste Teiler: 417.9 (31.), 445.9 (35.), 607.3 (36.)
 Trefferlage: 6.29 mm links, 10.90 mm tief
 Streuwert: 9.79, horizontal: 9.95, vertikal: 9.63



Ergebnis: **347** (368.7)
 Serien: 83 90 85 89
 Zähler: 5 21 10 4 0 0 0 0 0 0
 Innenzehner: 2
 Weitester: 2973 (4.), 2669 (8.), 2455 (16.)
 beste Teiler: 330.9 (17.), 448.0 (14.), 624.0 (19.)
 Trefferlage: 8.64 mm rechts, 2.26 mm tief
 Streuwert: 8.68, horizontal: 7.86, vertikal: 9.42

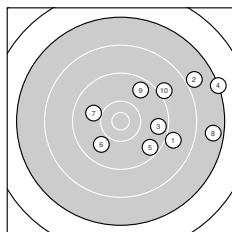
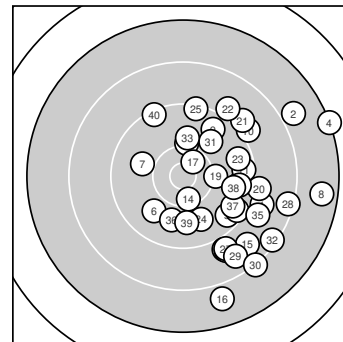

Serie 1: 83 (89.1)

8.9 →	7.9 ↗	9.6 →	7.2 →	9.5 ↘
9.9 ↙	9.9 ←	7.6 →	9.6 ↗	9.0 ↗

beste Teiler: 807.6 (7.), 861.9 (6.), 1061.0 (9.)
 Trefferlage: 11.47 mm rechts, 1.78 mm hoch
 Streuwert: 10.06, horizontal: 12.03, vertikal: 7.60

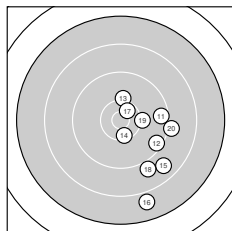

Serie 2: 90 (94.8)

9.5 →	9.4 ↘	10.2 ↑	10.4* ↓	8.7 ↘
7.9 ↓	10.5* ↗	8.9 ↘	10.2 →	9.1 →

beste Teiler: 330.9 (17.), 448.0 (14.), 624.0 (19.)
 Trefferlage: 7.39 mm rechts, 5.34 mm tief
 Streuwert: 7.30, horizontal: 4.92, vertikal: 9.07

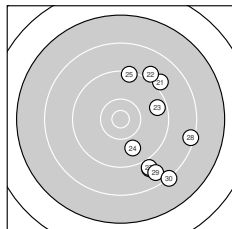

Serie 3: 85 (89.8)

9.0 ↗	9.0 ↗	9.6 →	9.8 ↓	9.3 ↑
8.9 ↘	8.9 ↘	8.4 →	8.7 ↓	8.2 ↘

beste Teiler: 893.6 (24.), 1102.8 (23.), 1307.5 (25.)
 Trefferlage: 9.67 mm rechts, 3.40 mm tief
 Streuwert: 9.34, horizontal: 5.00, vertikal: 12.23

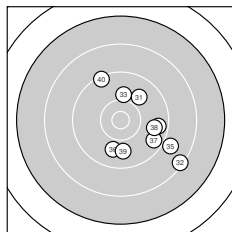

Serie 4: 89 (95.0)

9.9 ↗	8.3 ↘	10.0 ↑	9.6 →	8.9 ↘
9.9 ↓	9.6 ↘	9.7 →	9.8 ↓	9.3 ↗

beste Teiler: 733.9 (33.), 846.3 (31.), 862.7 (36.)
 Trefferlage: 6.04 mm rechts, 2.07 mm tief
 Streuwert: 7.73, horizontal: 7.39, vertikal: 8.04



LP 40

StandNr: 114

Ritter,, Josef #360**Senioren_2m**

Wertung

StartNr: 71

11.01.2025 15:29

SG_Sportschützen_St._Johann

Ergebnis: **352** (371.0)
 Serien: 84 92 87 89
 Zähler: 13 12 9 6 0 0 0 0 0 0
 Innenzehner: 6
 Weitesten: 3041 (23.), 2823 (21.), 2715 (9.)
 beste Teiler: 111.9 (24.), 122.9 (10.), 203.4 (18.)
 Trefferlage: 2.35 mm rechts, 1.54 mm hoch
 Streuwert: 11.25, horizontal: 11.38, vertikal: 11.10

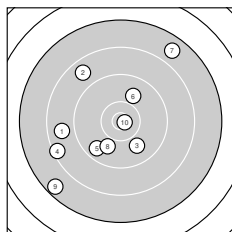
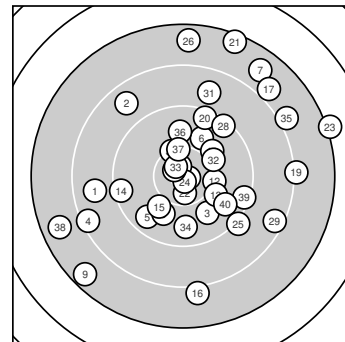
**Serie 1: 84 (91.3)**

8.8 ←	8.7 ↘	9.9 ↘	8.4 ←	9.6 ↗
9.9 ↗	7.7 ↗	9.9 ↘	7.6 ↗	10.8* →

beste Teiler: 122.9 (10.), 830.1 (8.), 831.8 (6.)
 Trefferlage: 5.20 mm links, 1.11 mm tief
 Streuwert: 11.77, horizontal: 11.52, vertikal: 12.02

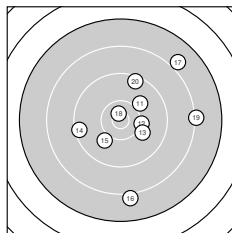
**Serie 2: 92 (94.0)**

10.0 ↗	10.2 →	10.0 ↘	9.4 ←	10.0 ↗
8.1 ↓	8.0 ↗	10.7* ↑	8.2 →	9.4 ↗

beste Teiler: 203.4 (18.), 623.9 (12.), 740.6 (13.)
 Trefferlage: 4.72 mm rechts, 0.02 mm tief
 Streuwert: 10.27, horizontal: 9.80, vertikal: 10.72

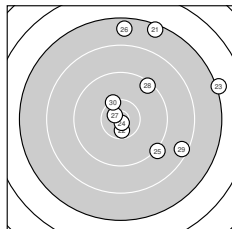
**Serie 3: 87 (91.4)**

7.4 ↗	10.5* ↓	7.1 →	10.8* ↓	9.2 ↘
7.6 ↑	10.7* ↘	9.4 ↗	8.4 →	10.3 ↑

beste Teiler: 111.9 (24.), 206.9 (27.), 333.1 (22.)
 Trefferlage: 7.36 mm rechts, 5.60 mm hoch
 Streuwert: 11.52, horizontal: 10.03, vertikal: 12.83

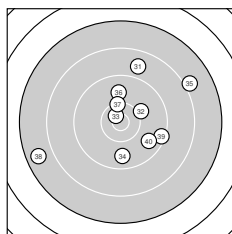
**Serie 4: 89 (94.3)**

8.8 ↗	10.1 ↗	10.7* ↘	9.7 ↓	8.0 ↗
9.9 ↑	10.3 ↑	7.7 ←	9.4 →	9.7 ↘

beste Teiler: 230.6 (33.), 533.6 (37.), 679.5 (32.)
 Trefferlage: 2.52 mm rechts, 1.71 mm hoch
 Streuwert: 10.39, horizontal: 11.60, vertikal: 9.02



Ergebnis: **376** (390.2)
 Serien: 91 96 98 91
 Zähler: 18 20 2 0 0 0 0 0 0 0 0
 Innenzehner: 5
 Weitester: 2074 (8.), 1788 (31.), 1595 (18.)
 beste Teiler: 235.7 (27.), 307.3 (30.), 319.7 (22.)
 Trefferlage: 0.73 mm links, 0.19 mm tief
 Streuwert: 7.46, horizontal: 6.80, vertikal: 8.06

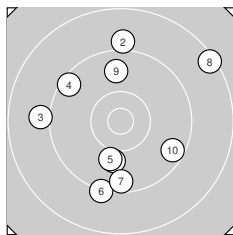
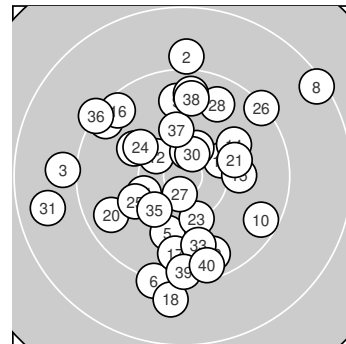

Serie 1: 91 (93.7)

10.0 ↓ 9.0 ↑ 9.0 ← 9.4 ↖ 10.0 ↓
 9.2 ↓ 9.5 ↓ 8.4 ↗ 9.7 ↑ 9.5 ↘
 beste Teiler: 757.3 (5.), 780.4 (1.), 971.8 (9.)
 Trefferlage: 0.55 mm links, 0.11 mm tief
 Streuwert: 9.80, horizontal: 9.15, vertikal: 10.41

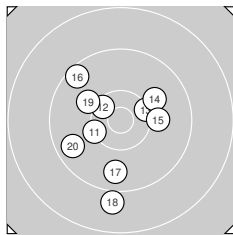

Serie 2: 96 (98.8)

10.3 ↖ 10.4* ↖ 10.3 → 10.0 ↗ 10.0 →
 9.5 ↖ 9.7 ↓ 9.0 ↓ 10.0 ↖ 9.6 ↖
 beste Teiler: 429.4 (12.), 529.4 (13.), 550.7 (11.)
 Trefferlage: 1.62 mm links, 1.22 mm tief
 Streuwert: 6.70, horizontal: 6.05, vertikal: 7.29

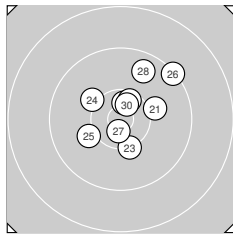

Serie 3: 98 (101.8)

10.1 → 10.6* ↑ 10.2 ↓ 10.1 ↖ 10.1 ↖
 9.3 ↗ 10.7* ↓ 9.7 ↗ 10.4* ↑ 10.6* ↑
 beste Teiler: 235.7 (27.), 307.3 (30.), 319.7 (22.)
 Trefferlage: 1.43 mm rechts, 2.24 mm hoch
 Streuwert: 4.88, horizontal: 4.96, vertikal: 4.80

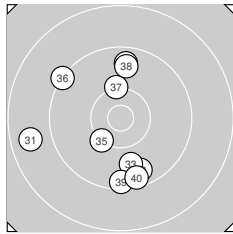

Serie 4: 91 (95.9)

8.7 ← 9.6 ↓ 9.8 ↓ 9.6 ↑ 10.2 ↖
 9.2 ↖ 10.2 ↑ 9.7 ↑ 9.4 ↓ 9.5 ↓
 beste Teiler: 564.6 (35.), 604.0 (37.), 909.0 (33.)
 Trefferlage: 2.20 mm links, 1.67 mm tief
 Streuwert: 8.17, horizontal: 6.87, vertikal: 9.30



Ergebnis: **385** (404.9)
 Serien: 93 98 96 98
 Zähler: 26 13 1 0 0 0 0 0 0 0
 Innenzehner: 15
 Weitester: 1604 (2.), 1443 (9.), 1282 (8.)
 beste Teiler: 158.8 (16.), 173.3 (34.), 217.3 (36.)
 Trefferlage: 1.64 mm links, 1.07 mm tief
 Streuwert: 5.18, horizontal: 2.54, vertikal: 6.87

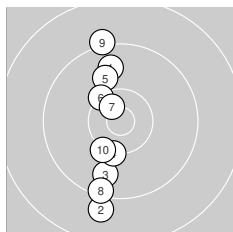
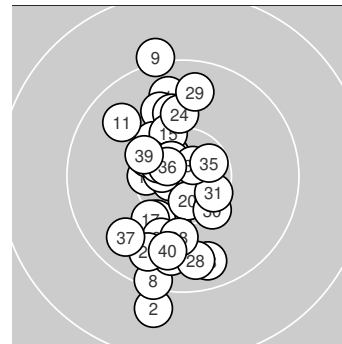

Serie 1: 93 (97.9)

9.7 ↑ 8.9 ↓ 9.7 ↓ 10.2 ↓ 9.9 ↑
 10.3 ↘ 10.6* ↘ 9.3 ↓ 9.1 ↑ 10.2 ✓
 beste Teiler: 300.9 (7.), 546.0 (6.), 585.3 (4.)
 Trefferlage: 2.69 mm links, 1.01 mm tief
 Streuwert: 7.12, horizontal: 0.86, vertikal: 10.03

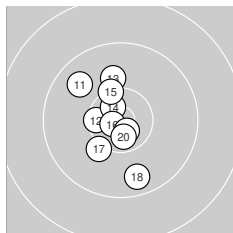

Serie 2: 98 (102.8)

9.7 ↘ 10.4* ← 10.0 ↑ 10.6* ↘ 10.3 ↑
 10.8* ↙ 10.1 ✓ 9.6 ↓ 10.7* ↘ 10.6* ↓
 beste Teiler: 158.8 (16.), 217.8 (19.), 269.7 (14.)
 Trefferlage: 1.67 mm links, 0.06 mm hoch
 Streuwert: 4.37, horizontal: 2.93, vertikal: 5.44



Serie 3: 96 (100.7)

9.8 ↓ 10.6* ← 10.0 ↓ 10.0 ↑ 10.4* ↘
 9.7 ↓ 10.5* ↘ 9.7 ↓ 9.7 ↑ 10.3 ↘
 beste Teiler: 252.4 (22.), 322.4 (27.), 460.6 (25.)
 Trefferlage: 1.16 mm links, 1.83 mm tief
 Streuwert: 5.40, horizontal: 2.58, vertikal: 7.19

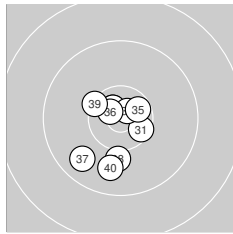

Serie 4: 98 (103.5)

10.4* ↘ 10.7* ↘ 10.7* ↘ 10.7* ↗ 10.5* ↗
 10.7* ↘ 9.7 ✓ 10.0 ↓ 10.3 ↘ 9.8 ↓
 beste Teiler: 173.3 (34.), 217.3 (36.), 230.8 (33.)
 Trefferlage: 1.04 mm links, 1.50 mm tief
 Streuwert: 3.90, horizontal: 3.19, vertikal: 4.50



Ergebnis: **378** (394.4)
 Serien: 95 95 96 92
 Zähler: 23 13 3 1 0 0 0 0 0 0
 Innenzehner: 13
 Weitester: 2796 (16.), 2271 (40.), 1895 (37.)
 beste Teiler: 92.0 (29.), 110.6 (8.), 162.8 (31.)
 Trefferlage: 0.64 mm links, 0.23 mm hoch
 Streuwert: 7.66, horizontal: 3.35, vertikal: 10.30

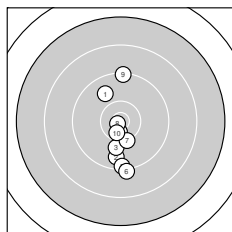
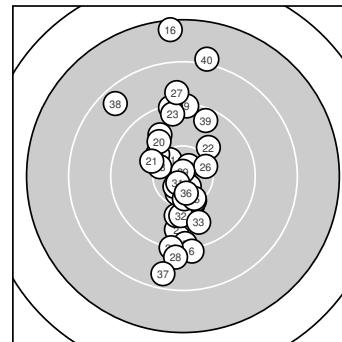

Serie 1: 95 (99.4)

9.8 ↘	9.7 ↓	10.0 ↓	10.6* ↓	9.3 ↓
9.2 ↓	10.2 ↓	10.8* ↗	9.3 ↑	10.5* ↓

beste Teiler: 110.6 (8.), 304.7 (4.), 345.6 (10.)
 Trefferlage: 0.45 mm links, 3.60 mm tief
 Streuwert: 6.31, horizontal: 1.81, vertikal: 8.74

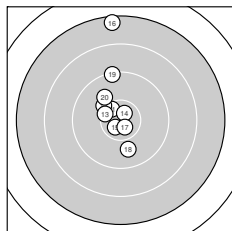

Serie 2: 95 (99.8)

10.5* ↘	10.2 ↘	10.4 ↖	10.7* ↗	10.6* ↗
7.5 ↑	10.7* ↘	9.9 ↓	9.3 ↑	10.0 ↘

beste Teiler: 227.2 (14.), 230.6 (17.), 250.2 (15.)
 Trefferlage: 1.81 mm links, 4.63 mm hoch
 Streuwert: 7.24, horizontal: 2.53, vertikal: 9.92

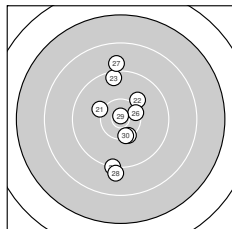

Serie 3: 96 (98.6)

10.1 ↖	10.0 ↗	9.5 ↑	9.2 ↓	10.3 ↓
10.4* ↗	9.0 ↑	9.0 ↓	10.8* ↑	10.3 ↓

beste Teiler: 92.0 (29.), 470.3 (26.), 493.7 (30.)
 Trefferlage: 0.00 mm , 0.04 mm hoch
 Streuwert: 7.44, horizontal: 3.28, vertikal: 10.00

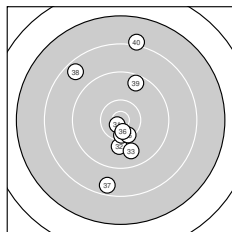

Serie 4: 92 (96.6)

10.7* ↗	10.0 ↓	9.8 ↓	10.4* ↓	10.4* ↓
10.5* ↓	8.6 ↓	8.6 ↖	9.5 ↑	8.1 ↑

beste Teiler: 162.8 (31.), 329.0 (36.), 431.7 (34.)
 Trefferlage: 0.31 mm links, 0.12 mm tief
 Streuwert: 9.30, horizontal: 5.10, vertikal: 12.13



Ergebnis: **369** (385.6)
 Serien: 92 90 93 94
 Zähler: 19 12 8 1 0 0 0 0 0 0
 Innenzehner: 10
 Weitester: 2485 (26.), 2378 (11.), 2353 (7.)
 beste Teiler: 171.4 (21.), 271.3 (6.), 327.5 (38.)
 Trefferlage: 0.98 mm links, 5.06 mm tief
 Streuwert: 8.07, horizontal: 6.13, vertikal: 9.63

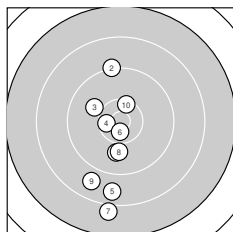
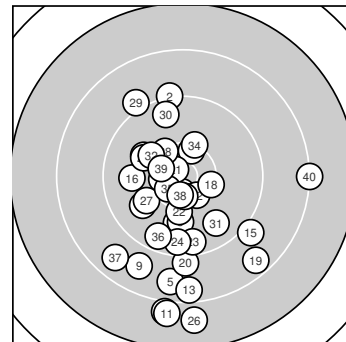

Serie 1: 92 (96.1)
 9.9 ↓ 9.2 ↑ 10.0 ↘ 10.5* ← 8.7 ↓
 10.6* ↓ 8.0 ↓ 10.0 ↓ 8.8 ↗ 10.4* ↑
 beste Teiler: 271.3 (6.), 368.8 (4.), 459.7 (10.)
 Trefferlage: 2.58 mm links, 5.43 mm tief
 Streuwert: 8.32, horizontal: 2.84, vertikal: 11.42

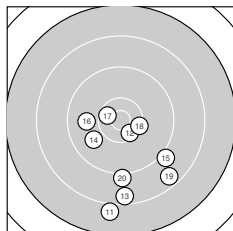

Serie 2: 90 (94.3)
 8.0 ↓ 10.4* ↘ 8.5 ↓ 9.9 ↖ 9.1 ↘
 9.9 ← 10.5* ↖ 10.3 → 8.6 ↘ 9.1 ↓
 beste Teiler: 359.9 (17.), 404.6 (12.), 506.2 (18.)
 Trefferlage: 1.10 mm rechts, 9.12 mm tief
 Streuwert: 7.93, horizontal: 7.12, vertikal: 8.67

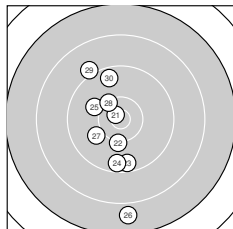

Serie 3: 93 (96.7)
 10.7* ↘ 10.2 ↓ 9.5 ↓ 9.5 ↓ 10.0 ↖
 7.8 ↓ 10.0 ↖ 10.3 ↘ 9.1 ↘ 9.6 ↑
 beste Teiler: 171.4 (21.), 526.8 (28.), 613.4 (22.)
 Trefferlage: 2.64 mm links, 2.59 mm tief
 Streuwert: 8.39, horizontal: 3.47, vertikal: 11.35

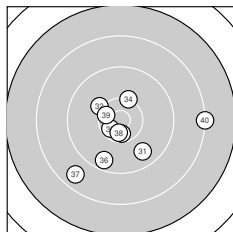

Serie 4: 94 (98.5)
 9.7 ↘ 10.1 ↖ 10.5* ↓ 10.2 ↑ 10.5* ↖
 9.6 ↗ 8.7 ↗ 10.5* ↓ 10.5* ↖ 8.2 →
 beste Teiler: 327.5 (38.), 341.6 (35.), 350.2 (33.)
 Trefferlage: 0.15 mm rechts, 3.10 mm tief
 Streuwert: 7.67, horizontal: 8.92, vertikal: 6.17



Ergebnis: **359** (377.1)
 Serien: 87 89 92 91
 Zähler: 11 20 7 1 1 0 0 0 0 0 0
 Innenzehner: 5
 Weitesten: 3299 (9.), 2431 (2.), 2388 (3.)
 beste Teiler: 244.7 (24.), 274.6 (10.), 340.2 (35.)
 Trefferlage: 5.61 mm rechts, 2.59 mm hoch
 Streuwert: 8.87, horizontal: 6.04, vertikal: 10.99

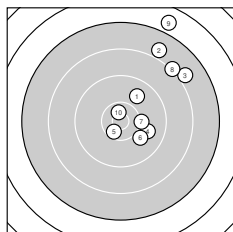
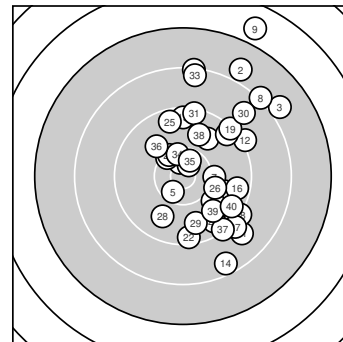

Serie 1: 87 (91.9)

9.8 ↗	7.9 ↗	8.0 ↗	9.9 →	10.5* ↘
10.0 ↘	10.2 →	8.2 ↗	6.8 ↗	10.6* ↗

beste Teiler: 274.6 (10.), 373.9 (5.), 629.1 (7.)
 Trefferlage: 8.38 mm rechts, 7.95 mm hoch
 Streuwert: 9.67, horizontal: 6.94, vertikal: 11.78

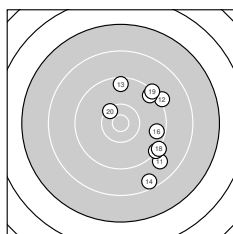

Serie 2: 89 (93.1)

8.9 ↘	9.1 ↗	9.5 ↑	8.5 ↘	9.4 ↗
9.6 →	9.3 ↘	9.2 ↘	9.3 ↗	10.3 ↘

beste Teiler: 482.6 (20.), 1115.0 (16.), 1178.0 (13.)
 Trefferlage: 8.11 mm rechts, 0.69 mm tief
 Streuwert: 8.13, horizontal: 5.31, vertikal: 10.20

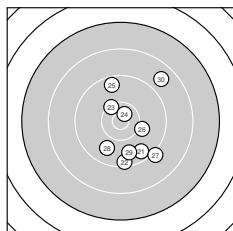

Serie 3: 92 (96.8)

9.6 ↘	9.4 ↓	10.3 ↘	10.6* ↗	9.5 ↑
10.1 →	9.1 ↘	9.8 ↘	9.7 ↘	8.7 ↗

beste Teiler: 244.7 (24.), 509.4 (23.), 686.3 (26.)
 Trefferlage: 3.07 mm rechts, 2.12 mm tief
 Streuwert: 7.60, horizontal: 5.64, vertikal: 9.14

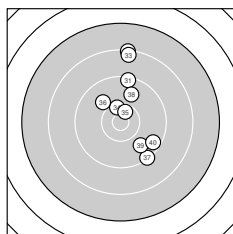

Serie 4: 91 (95.3)

9.3 ↑	8.3 ↑	8.4 ↑	10.4* ↑	10.5* ↗
10.0 ↘	9.3 ↘	9.8 ↗	9.8 ↘	9.5 ↘

beste Teiler: 340.2 (35.), 453.7 (34.), 799.8 (36.)
 Trefferlage: 2.89 mm rechts, 5.23 mm hoch
 Streuwert: 8.35, horizontal: 4.34, vertikal: 10.98



Ergebnis: **324** (343.6)
 Serien: 81 81 80 82
 Zähler: 5 9 15 8 2 1 0 0 0 0 0
 Innenzehner: 2
 Weitester: 4799 (37.), 3643 (8.), 3502 (27.)
 beste Teiler: 404.0 (18.), 471.0 (23.), 506.2 (31.)
 Trefferlage: 5.02 mm links, 2.54 mm tief
 Streuwert: 14.62, horizontal: 13.82, vertikal: 15.37

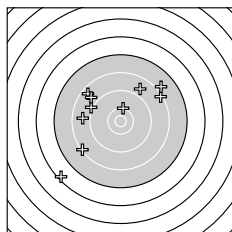
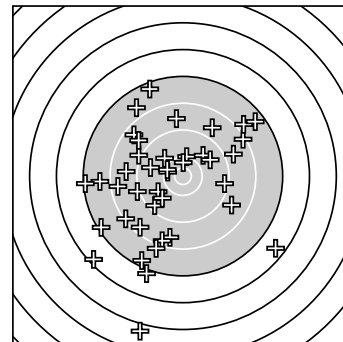

Serie 1: 81 (85.3)

9.1 ↖	8.3 ↗	8.6 ↘	8.8 ↗	8.0 ↗
8.3 ↙	8.8 ↘	6.4 ↙	8.8 ←	10.2 ↑

beste Teiler: 591.5 (10.), 1459.1 (1.), 1687.3 (4.)
 Trefferlage: 5.58 mm links, 3.97 mm hoch
 Streuwert: 14.52, horizontal: 15.87, vertikal: 13.04

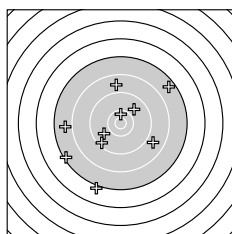

Serie 2: 81 (87.0)

8.8 ↑	7.3 ↙	9.9 ↙	8.8 ↘	7.1 ↓
7.8 ←	7.6 ↗	10.4* ↑	9.4 ↙	9.9 ↗

beste Teiler: 404.0 (18.), 862.7 (20.), 876.7 (13.)
 Trefferlage: 3.57 mm links, 2.43 mm tief
 Streuwert: 14.63, horizontal: 15.06, vertikal: 14.18

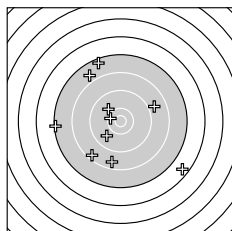

Serie 3: 80 (85.5)

7.3 ←	8.9 ↗	10.4* ←	7.5 ↖	8.6 ↓
10.0 ↘	6.6 ↘	8.5 ↙	7.9 ↖	9.8 ↙

beste Teiler: 471.0 (23.), 763.0 (26.), 900.5 (30.)
 Trefferlage: 4.31 mm links, 0.43 mm tief
 Streuwert: 15.73, horizontal: 15.68, vertikal: 15.78

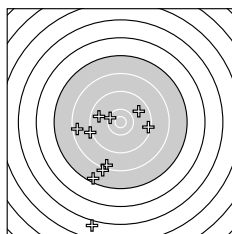

Serie 4: 82 (85.8)

10.3 ↖	8.5 ←	8.4 ↓	9.2 ←	8.1 ↓
9.8 ↗	5.0 ↓	7.4 ↓	9.7 ←	9.4 →

beste Teiler: 506.2 (31.), 946.8 (36.), 1002.5 (39.)
 Trefferlage: 6.61 mm links, 11.28 mm tief
 Streuwert: 13.51, horizontal: 9.88, vertikal: 16.35



Ergebnis: **323** (339.4)
 Serien: 77 82 84 80
 Zähler: 3 18 6 7 5 0 1 0 0 0 0
 Innenzehner: 3
 Weitester: 4815 (34.), 3759 (12.), 3720 (3.)
 beste Teiler: 275.0 (7.), 353.4 (16.), 458.5 (30.)
 Trefferlage: 6.38 mm links, 4.57 mm tief
 Streuwert: 14.85, horizontal: 13.99, vertikal: 15.65

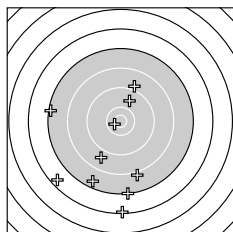
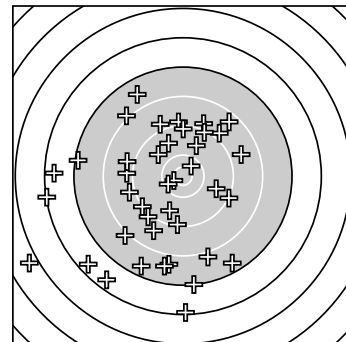

Serie 1: 77 (81.2)

9.0 ↗	7.2 ↓	6.3 ↓	9.8 ↗	7.3 ←
8.8 ↘	10.6* ↖	6.5 ↘	8.1 ↓	7.6 ↘

beste Teiler: 275.0 (7.), 908.5 (4.), 1537.5 (1.)
 Trefferlage: 5.65 mm links, 12.65 mm tief
 Streuwert: 15.47, horizontal: 12.77, vertikal: 17.76

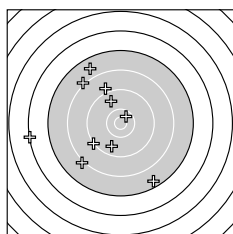

Serie 2: 82 (85.9)

9.7 ↘	6.3 ←	9.2 ↘	7.5 ↓	8.1 ↖
10.5* ↗	9.0 ↖	7.8 ↖	9.7 ↖	8.1 ↘

beste Teiler: 353.4 (16.), 978.9 (19.), 1011.7 (11.)
 Trefferlage: 8.99 mm links, 0.11 mm hoch
 Streuwert: 14.26, horizontal: 13.28, vertikal: 15.17

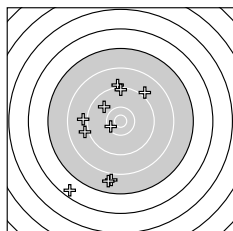

Serie 3: 84 (87.9)

9.0 ←	9.1 ↑	9.0 ←	6.6 ↘	9.0 ↗
7.9 ↓	7.8 ↓	9.3 ↑	9.8 ↖	10.4* ↖

beste Teiler: 458.5 (30.), 893.7 (29.), 1287.0 (28.)
 Trefferlage: 6.16 mm links, 3.74 mm tief
 Streuwert: 13.17, horizontal: 8.84, vertikal: 16.40

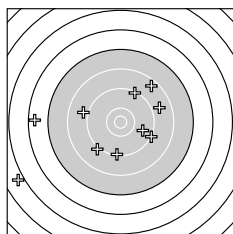

Serie 4: 80 (84.4)

6.6 ←	9.7 ↘	9.3 ↗	4.9 ↘	9.3 ↓
8.5 ↗	9.1 ↘	9.2 ↘	9.0 ←	8.8 ↘

beste Teiler: 970.0 (32.), 1327.8 (33.), 1330.4 (35.)
 Trefferlage: 4.74 mm links, 2.00 mm tief
 Streuwert: 16.76, horizontal: 20.49, vertikal: 11.92

